

SA SERIES

List

List..... 1

Package outline..... 2

Features..... 2

Mechanical data..... 2

Maximum ratings2

Electrical characteristics..... 3~4

Rating and characteristic curves..... 5

Pinning information..... 6

Taping & bulk specifications for AXIAL devices..... 6

Suggested thermal profiles for soldering processes..... 7

High reliability test capabilities.....8

SA SERIES

500W Axial Leaded Transient Voltage Suppressors - 5.0V-220V

Features

- Axial lead type devices for through hole design.
- 500W peak pulse power capability with a 10/1000us waveform, repetition rate (duty cycle): 0.01%.
- Excellent clamping capability.
- Low incremental surge resistance.
- Fast response time from 0V to V_{BR} , typically less than 1 ps for uni-directional & 5 ns for bi-directional types.
- Glass passivated chip junction.
- Lead-free parts meet environmental standards of MIL-STD-19500 /228
- Suffix "-H" indicates Halogen free parts, ex. SA5.0A-H

Mechanical data

- Epoxy : UL94-V0 rated flame retardant
- Case : Molded plastic, DO-15
- Lead : Axial leads, solderable per MIL-STD-202, Method 208 guaranteed
- Polarity: Color band denotes cathode end
- Mounting Position : Any
- Weight : Approximated 0.40 gram

Package outline

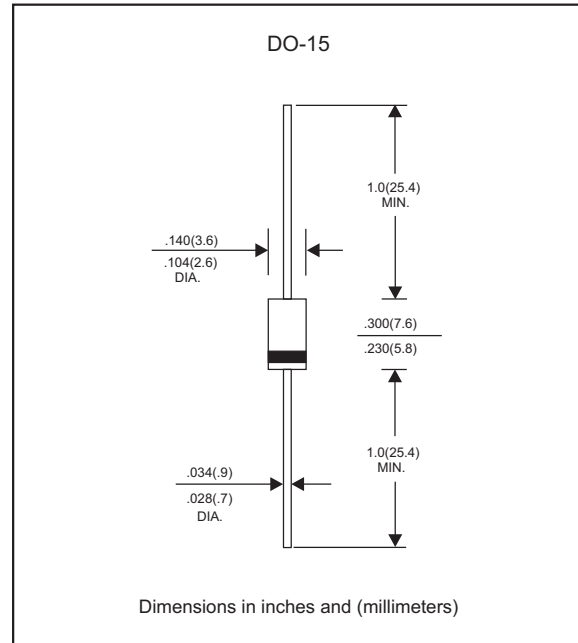

Maximum ratings (AT $T_A=25^\circ\text{C}$ unless otherwise noted)

PARAMETER	CONDITIONS	Symbol	SA SERIES	UNIT
Peak power dissipation	with a 10/1000us waveform, Note 1 & Fig. 1	P_{PPM}	500	W
Peak pulse current	with a 10/1000us waveform	I_{PPM}	See table 1	A
Steady state power dissipation	at $T_L=75^\circ\text{C}$ lead length 0.375" (9.5 mm)	$P_{M(AV)}$	3.0	W
Peak forward surge current	8.3ms single half sine-wave superimposed on rated load (JEDEC Method), note 2	I_{FSM}	70	A
Maximum instantaneous forward voltage	at 25A for uni-directional types only, note 3	V_F	3.5/5.0	V
Operating temperature range		T_J	-55~+150	$^\circ\text{C}$
Storage temperature range		T_{STG}	-55~+150	$^\circ\text{C}$

Note1. Non-repetitive current pulse, per Fig. 3 and derated above $T_A=25^\circ\text{C}$ per Fig. 2
 2. Measured on 8.3 mS single half sine-wave or equivalent square wave, duty cycle=4 pulses per minute maximum
 3. $V_F<3.5\text{V}$. for devices of $V_{BR}<200\text{V}$, and $V_F<5.0\text{V}$. for devices of $V_{BR}>201\text{V}$

Electrical characteristics (at $T_A=25^{\circ}\text{C}$ unless otherwise noted)

Table 1

Part No.	Reverse Stand-off Voltage	Breakdown Voltage @ I_T		Test Current	Maximum Clamping Voltage @ I_{PP}		Maximum Reverse Leakage Current
	V_{RWM}	$V_{BR\ Min}$	$V_{BR\ Max}$	I_T	$V_C@I_{PP}$		$I_R@V_{RWM}$
	Volts	Volts	Volts	mA	Volts	I_{PP} (A)	I_R (μA)
SA5.0(C)A	5.0	6.40	7.00	10	9.2	54.3	600
SA6.0(C)A	6.0	6.67	7.37	10	10.3	48.5	600
SA6.5(C)A	6.5	7.22	7.98	10	11.2	44.7	400
SA7.0(C)A	7.0	7.78	8.60	10	12.0	41.7	150
SA7.5(C)A	7.5	8.33	9.21	1.0	12.9	38.8	50
SA8.0(C)A	8.0	8.89	9.83	1.0	13.6	36.7	25
SA8.5(C)A	8.5	9.44	10.4	1.0	14.4	34.7	10
SA9.0(C)A	9.0	10.0	11.1	1.0	15.4	32.5	5
SA10(C)A	10.0	11.1	12.3	1.0	17.0	29.4	3
SA11(C)A	11.0	12.2	13.5	1.0	18.2	27.4	3
SA12(C)A	12.0	13.3	14.7	1.0	19.9	25.1	3
SA13(C)A	13.0	14.4	15.9	1.0	21.5	23.2	3
SA14(C)A	14.0	15.6	17.2	1.0	23.2	21.5	3
SA15(C)A	15.0	16.7	18.5	1.0	24.4	20.6	3
SA16(C)A	16.0	17.8	19.7	1.0	26.0	19.2	3
SA17(C)A	17.0	18.9	20.9	1.0	27.6	18.1	3
SA18(C)A	18.0	20.0	22.1	1.0	29.2	17.2	3
SA20(C)A	20.0	22.2	24.5	1.0	32.4	15.4	3
SA22(C)A	22.0	24.4	26.9	1.0	35.5	14.4	3
SA24(C)A	24.0	26.7	29.5	1.0	38.9	12.8	3
SA26(C)A	26.0	28.9	31.9	1.0	42.1	11.9	3
SA28(C)A	28.0	31.1	34.4	1.0	45.4	11.0	3
SA30(C)A	30.0	33.3	36.8	1.0	48.4	10.3	3
SA33(C)A	33.0	36.7	40.6	1.0	53.3	9.4	3
SA36(C)A	36.0	40.0	44.2	1.0	58.1	8.6	3
SA40(C)A	40.0	44.4	49.1	1.0	64.5	7.8	3
SA43(C)A	43.0	47.8	52.8	1.0	69.4	7.2	3
SA45(C)A	45.0	50.0	55.3	1.0	72.7	6.9	3
SA48(C)A	48.0	53.3	58.9	1.0	77.4	6.5	3
SA51(C)A	51.0	56.7	62.7	1.0	82.4	6.1	3
SA54(C)A	54.0	60.0	66.3	1.0	87.1	5.7	3
SA58(C)A	58.0	64.4	71.2	1.0	93.6	5.3	3
SA60(C)A	60.0	66.7	73.7	1.0	96.8	5.2	3
SA64(C)A	64.0	71.1	78.6	1.0	103.0	4.9	3
SA70(C)A	70.0	77.8	86.0	1.0	113.0	4.4	3
SA75(C)A	75.0	83.3	92.1	1.0	121.0	4.1	3
SA78(C)A	78.0	86.7	95.8	1.0	126.0	4.0	3
SA85(C)A	85.0	94.4	104.0	1.0	137.0	3.6	3
SA90(C)A	90.0	100.0	111.0	1.0	146	3.4	3
SA100(C)A	100.0	111.0	123.0	1.0	162	3.1	3
SA110(C)A	110.0	122.0	135.0	1.0	177	2.8	3
SA120(C)A	120.0	133.0	147.0	1.0	193	2.0	3

- Note 1. V_{BR} measured after I_T applied for 300us, I_T =square wave pulse or equivalent
 2. Surge current waveform per Fig. 3 and derated per Fig. 2
 3. For bi-directional types having V_{RWM} of 10 volts and less, the I_R limit is doubled
 4. Suffix 'C' denotes bi-directional devices. Suffix 'A' denotes 5% tolerance devices, no suffix denotes 10% tolerance devices.
 5. All terms and symbols are consistent with ANS/IEEE C62.35

SA SERIES

Electrical characteristics (at $T_A=25^\circ\text{C}$ unless otherwise noted) **Table 1**

Part No.	Reverse Stand-off Voltage	Breakdown Voltage @ I_T		Test Current	Maximum Clamping Voltage @ I_{PP}		Maximum Reverse Leakage Current
	V_{RWM}	$V_{BR Min}$	$V_{BR Max}$	I_T	$V_C@I_{PP}$		$I_R@V_{RWM}$
	Volts	Volts	Volts	mA	Volts	$I_{PP}(A)$	$I_R(\mu A)$
SA130(C)A	130	144	159	1.0	209	2.4	3
SA150(C)A	150	167	185	1.0	243	2.1	3
SA160(C)A	160	178	197	1.0	259	1.9	3
SA170(C)A	170	189	209	1.0	275	1.8	3
SA180(C)A	180	201	222	1.0	292	1.7	3
SA190(C)A	190	211	233	1.0	308	1.6	3
SA200(C)A	200	224	247	1.0	324	1.5	3
SA210(C)A	210	237	263	1.0	340	1.5	3
SA220(C)A	220	246	272	1.0	356	1.4	3

- Note 1. V_{BR} measured after I_T applied for 300us, I_T =square wave pulse or equivalent
- 2. Surge current waveform per Fig. 3 and derated per Fig. 2
- 3. For bi-directional types having V_{RWM} of 10 volts and less, the I_R limit is doubled
- 4. Suffix 'C' denotes bi-directional devices. Suffix 'A' denotes 5% tolerance devices, no suffix denotes 10% tolerance devices.
- 5. All terms and symbols are consistent with ANS/IEEE C62.35

Fig. A - Transients of several thousand volts can be clamped to a safe level by the TVS

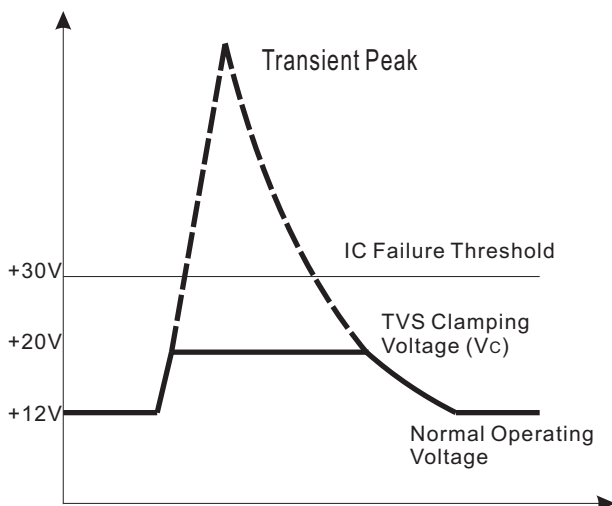
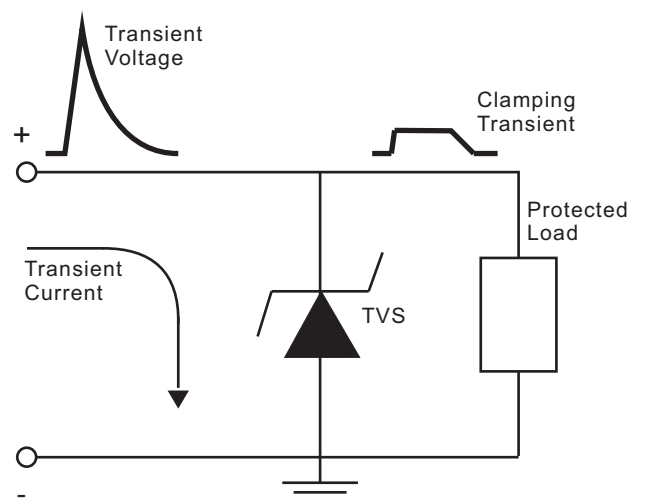

Fig. B - Transient current is diverted to ground thru TVS; the voltage seen by the protected load is limited to the clamping voltage level



Rating and characteristic curves (SA SERIES)

FIG.1 - PEAK PULSE POWER RATING CURVE

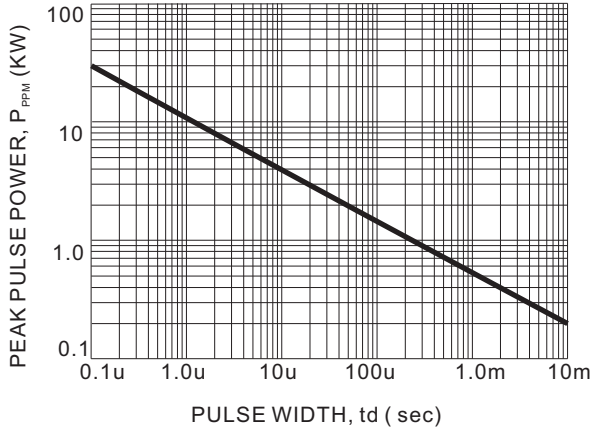

FIG.2 - PULSE DERATING CURVE

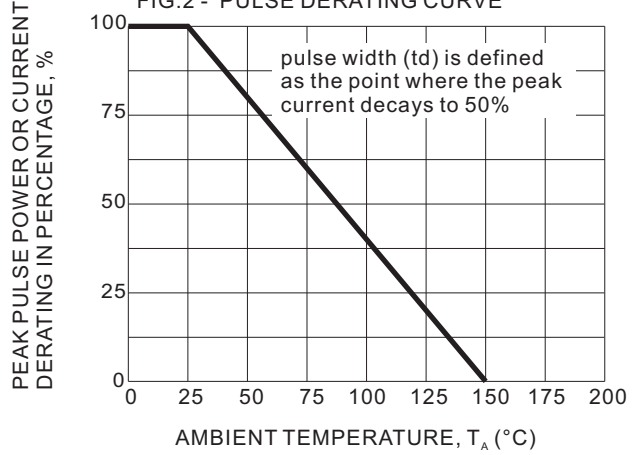

FIG.3 - PULSE WAVEFORM

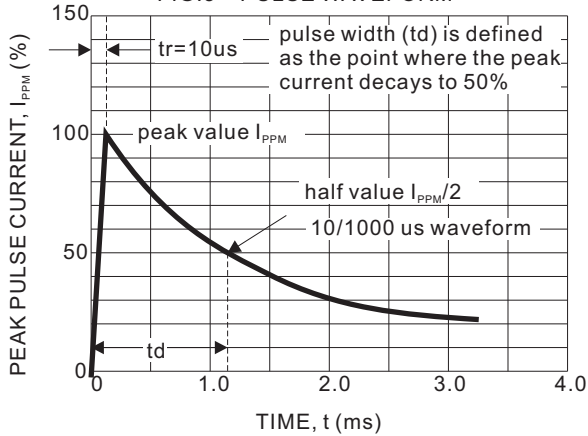

FIG.4 - TYPICAL JUNCTION CAPACITANCE

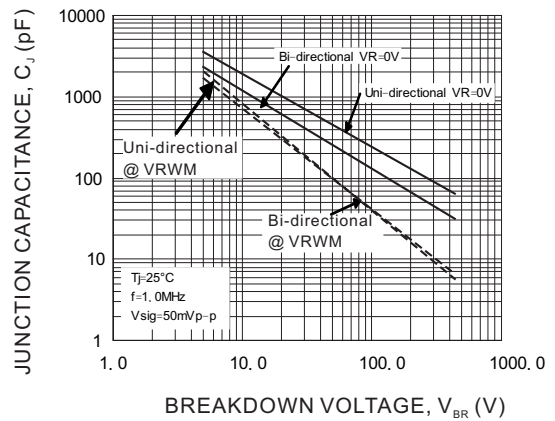

FIG.5 - STEADY STATE POWER DERATING CURVE

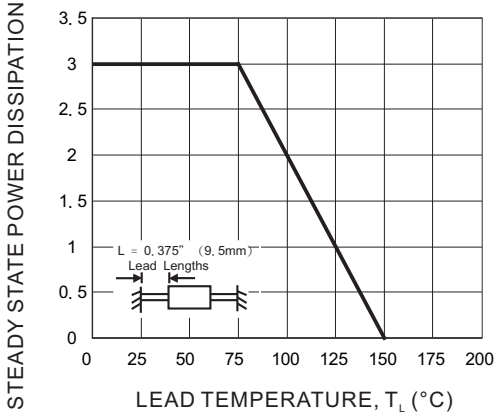
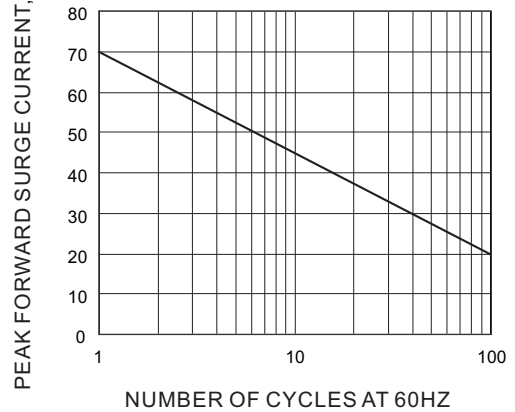





FIG.6 - MAXIMUM NON-REPETITIVE FORWARD SURGE CURRENT



SA SERIES

Pinning information

Pin	Simplified outline	Symbol
Uni-Directional Pin1 cathode Pin2 anode		
Bi-Directional		

Taping & bulk specifications for AXIAL devices

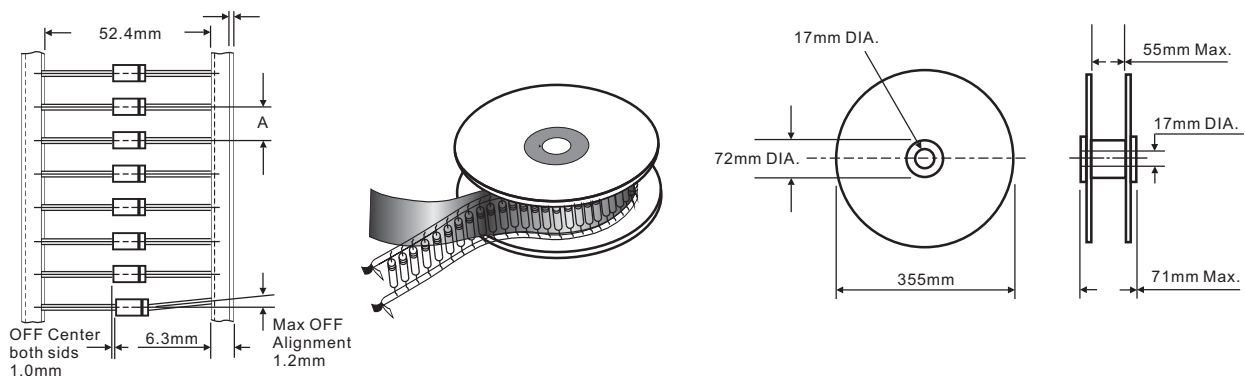

REEL PACKING

DEVICE CASE TYPE	Q'TY 1 (PCS / REEL)	COMPONENT SPACING "A" in FIG. A	CARTON SIZE (m/m)	Q'TY 2 (PCS / CARTON)	APPROX. CROSS WEIGHT(kg)
DO-15	4,000	5 mm	360 * 340 * 370	16,000	9.9

AMMO PACKING

DEVICE CASE TYPE	Q'TY 1 (PCS / BOX)	INNER BOX SIZE (m/m)	CARTON SIZE (m/m)	Q'TY 2 (PCS / CARTON)	APPROX. CROSS WEIGHT(kg)
DO-15	3,000	260 * 83 * 160	440 * 270 * 340	30,000	14.3

SA SERIES

BULK PACKING

DEVICE CASE TYPE	Q'TY 1 (PCS / BOX)	INNER BOX SIZE (m/m)	CARTON SIZE (m/m)	Q'TY 2 (PCS / CARTON)	APPROX. CROSS WEIGHT(kg)
DO-15	500	194 * 84 * 20	465 * 220 * 260	25,000	12.9

Suggested thermal profiles for soldering processes

1. Lead free temperature profile wave-soldering

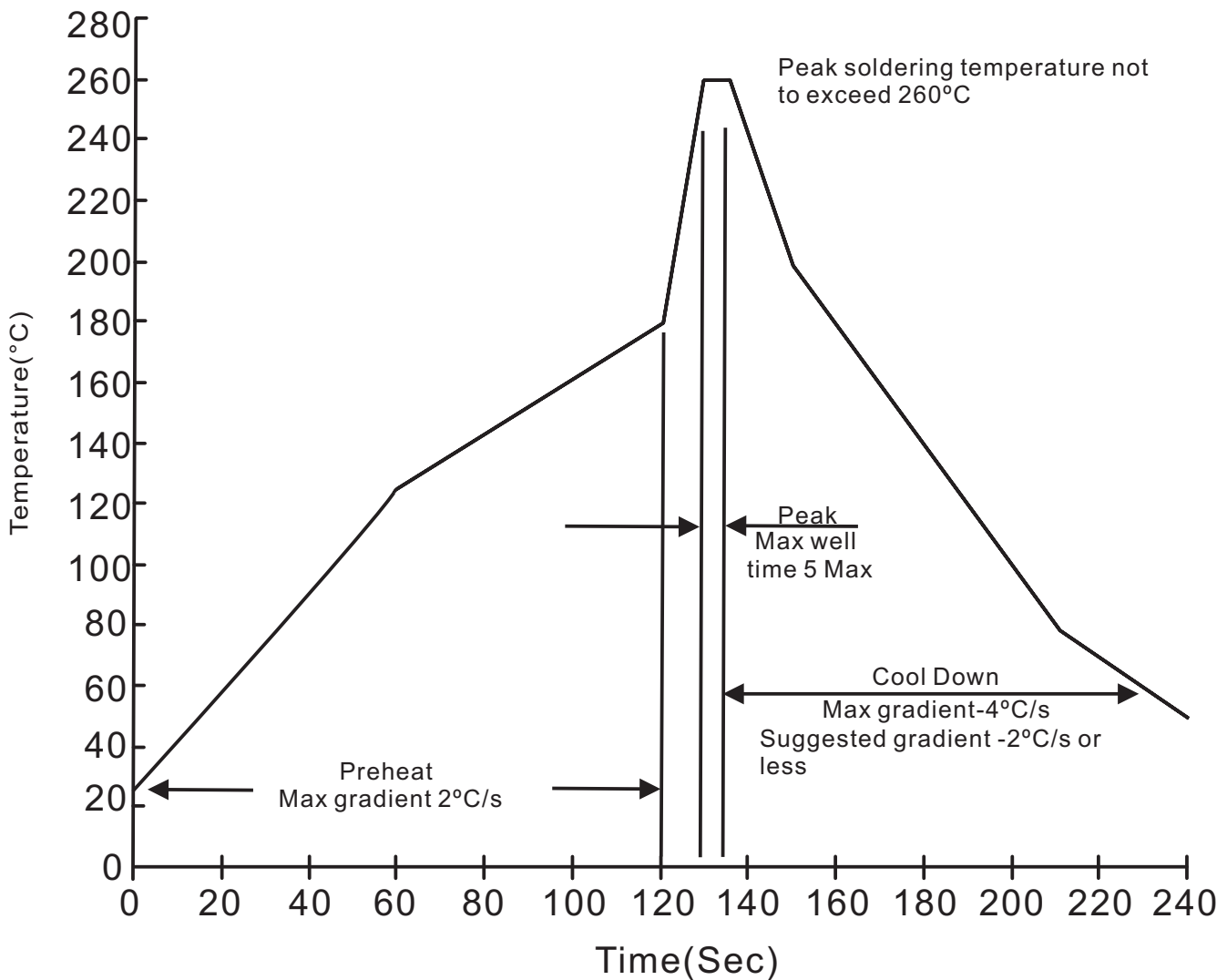

SA SERIES

High reliability test capabilities

Item Test	Conditions	Reference
1. Solder Resistance	at 260±5°C for 10±2sec. immerse body into solder 1/16"±1/32"	MIL-STD-750D METHOD-2031
2. Solderability	at 245±5°C for 5 sec.	MIL-STD-202F METHOD-208
3. Pull Test	1.0kg in axial lead direction for 10 sec.	MIL-STD-750D METHOD-2036
4. Bend Lead	1.0kg weight applied to each lead bending arc 90°±5° for 3 times.	MIL-STD-750D METHOD-2036
5. High Temperature Reverse Bias	V _{RWM} =80% rate at T _J =150°C for 168 hrs.	MIL-STD-750D METHOD-1038
8. Pressure Cooker	15P _{SIG} at T _A =121°C for 4 hrs.	JESD22-A102
7. Temperature Cycling	-55°C to +125°C dwelled for 30 min. and transferred for 5min. total 10 cycles.	MIL-STD-750D METHOD-1051
8. Thermal Shock	0°C for 5 min. rise to 100°C for 5 min. total 10 cycles.	MIL-STD-750D METHOD-1056
9. Humidity	at T _A =85°C, RH=85% for 1000hrs.	MIL-STD-750D METHOD-1021
10. High Temperature Storage Life	at 175°C for 1000 hrs.	MIL-STD-750D METHOD-1031