

RF & MICROWAVE TRANSISTORS HF SSB APPLICATIONS

- OPTIMIZED FOR SSB
- 30 MHz
- 28 VOLTS
- IMD -30dB
- EFFICIENCY 40%
- COMMON EMITTER
- GOLD METALLIZATION
- P_{OUT} = 220 W PEP WITH 12 dB GAIN

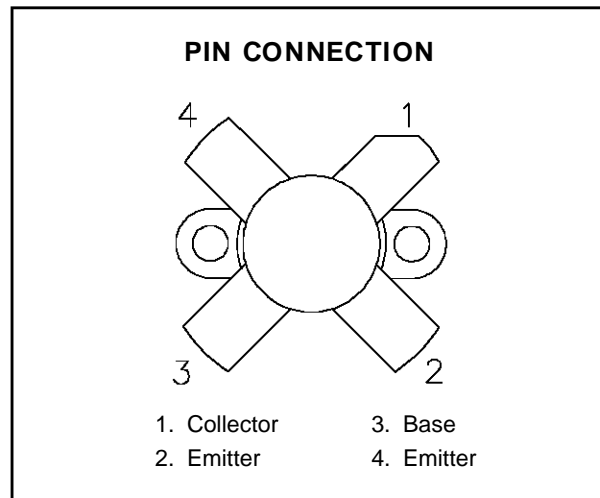
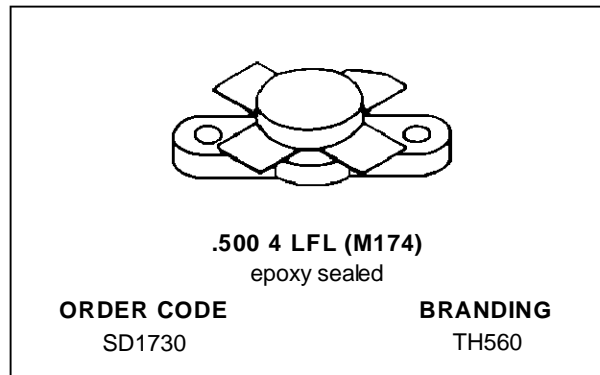

DESCRIPTION

The SD1730 is a 28 V epitaxial silicon NPN planar transistor designed primarily for SSB and VHF communications. The device utilizes emitter ballasting for improved ruggedness and reliability.

ABSOLUTE MAXIMUM RATINGS (T_{case} = 25°C)

Symbol	Parameter	Value	Unit
V _{CB0}	Collector-Base Voltage	70	V
V _{CEO}	Collector-Emitter Voltage	35	V
V _{EBO}	Emitter-Base Voltage	4.0	V
I _c	Device Current	16	A
P _{DISS}	Power Dissipation	320	W
T _J	Junction Temperature	+200	°C
T _{STG}	Storage Temperature	- 65 to +150	°C

THERMAL DATA

R _{TH(j-c)}	Junction-Case Thermal Resistance	0.6	°C/W
----------------------	----------------------------------	-----	------

SD1730 (TH560)

ELECTRICAL SPECIFICATIONS (T_{case} = 25°C)

STATIC

Symbol	Test Conditions		Value			Unit
			Min.	Typ.	Max.	
BV _{CES}	I _C = 100 mA	V _{BE} = 0 V	70	—	—	V
BV _{CEO}	I _C = 200 mA	I _B = 0 mA	35	—	—	V
BV _{EBO}	I _E = 20 mA	I _C = 0 mA	4.0	—	—	V
I _{CEO}	V _{CE} = 30 V	I _E = 0 mA	—	—	5	mA
I _{CES}	V _{CE} = 35 V	I _E = 0 mA	—	—	5	mA
h _{FE}	V _{CE} = 5 V	I _C = 7 A	15	—	60	—

DYNAMIC

Symbol	Test Conditions			Value			Unit
				Min.	Typ.	Max.	
P _{OUT}	f = 30 MHz	V _{CE} = 28 V	I _{CQ} = 750 mA	220	—	—	W
P _G *	P _{OUT} = 220 W PEP	V _{CE} = 28 V	I _{CQ} = 750 mA	12	—	—	dB
IMD*	P _{OUT} = 220 W PEP	V _{CE} = 28 V	I _{CQ} = 750 mA	—	—	-30	dBc
η _c *	P _{OUT} = 220 W PEP	V _{CE} = 28 V	I _{CQ} = 750 mA	40	—	—	%
C _{OB}	f = 1 MHz	V _{CB} = 28 V		—	450	—	pF
Load Mismatch	P _{OUT} = 220 W PEP	V _{CE} = 28 V	I _{CQ} = 750 mA	—	∞:1	—	VSWR

Note: * f₁ = 30.00 MHz, f₂ = 30.001 MHz

TYPICAL PERFORMANCE

POWER OUTPUT PEP vs POWER INPUT

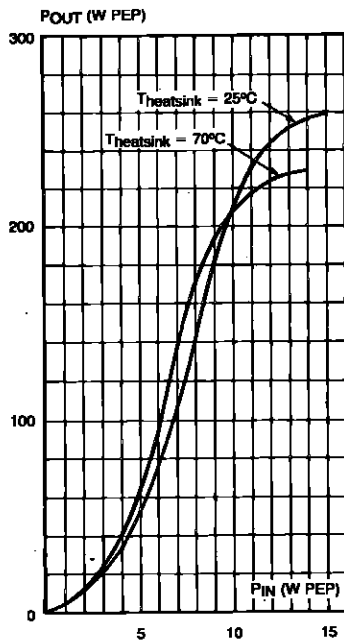

COLLECTOR EFFICIENCY vs POWER OUTPUT PEP

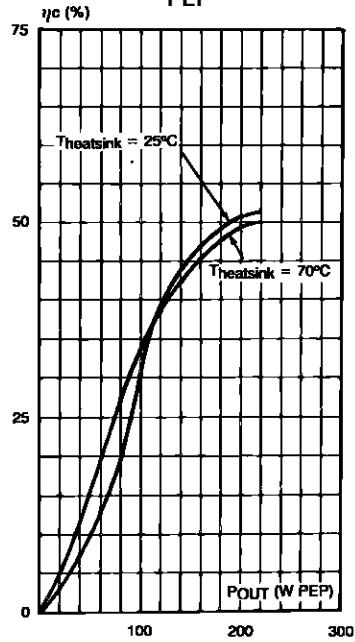

TYPICAL PERFORMANCE (cont'd)

INTERMODULATION DISTORTION vs POWER OUTPUT PEP

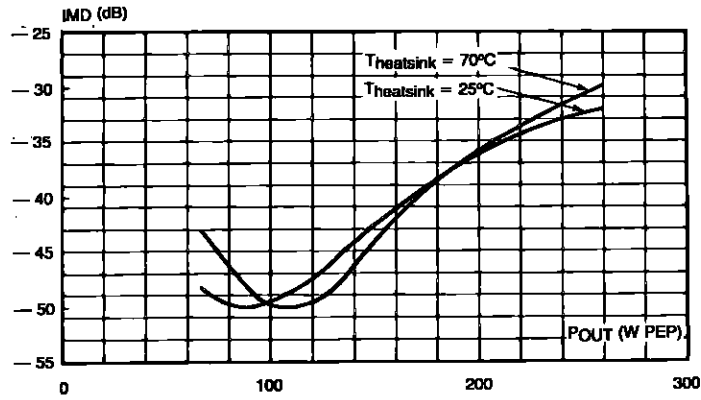

POWER GAIN vs POWER OUTPUT

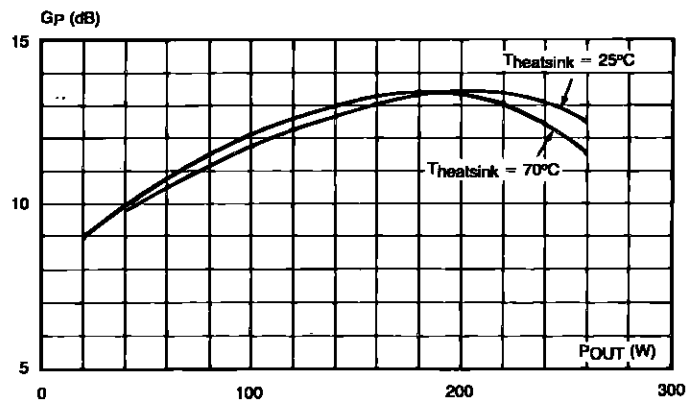

IMPEDANCE DATA

FREQ.	Z _{IN} (Ω)	Z _{CL} (Ω)
30 MHz	1.15 + j 0.41	1.25 + j 1.92

SD1730 (TH560)

TEST CIRCUIT

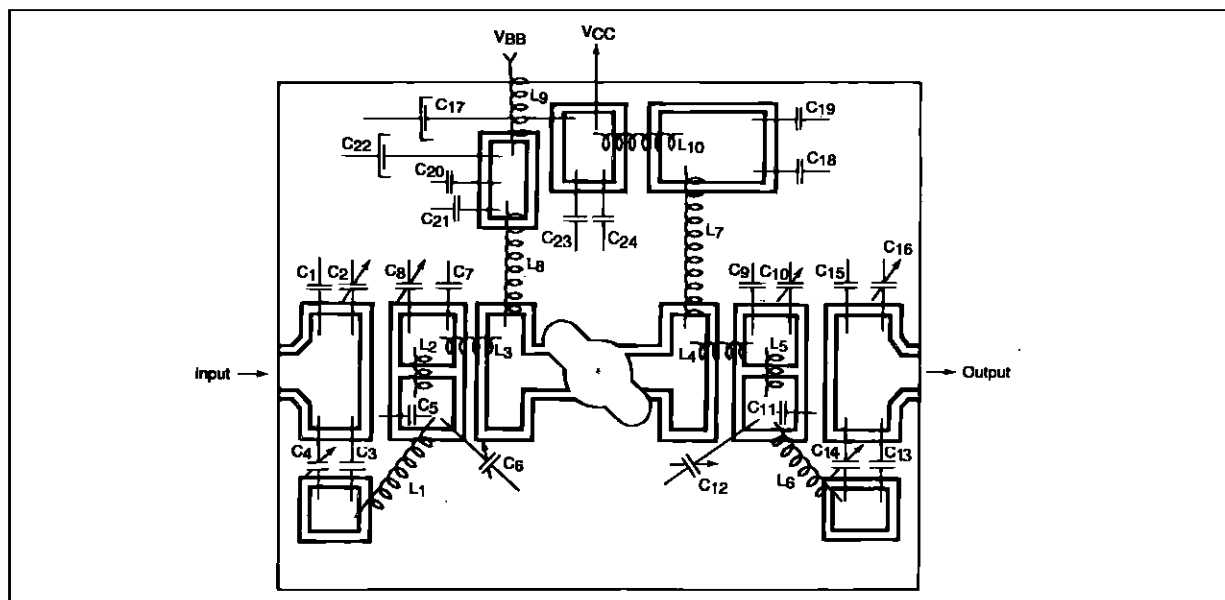
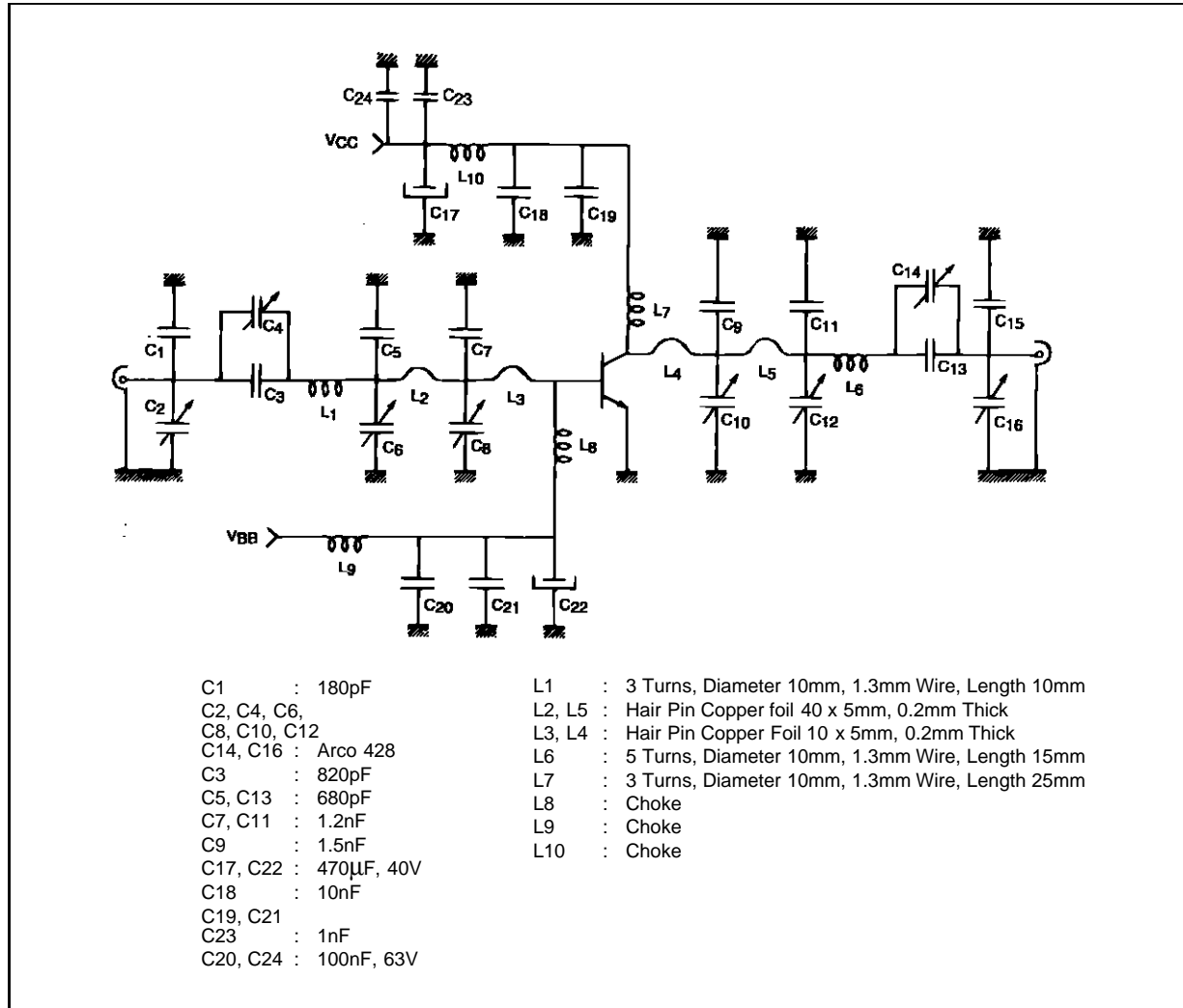

BIAS CIRCUIT

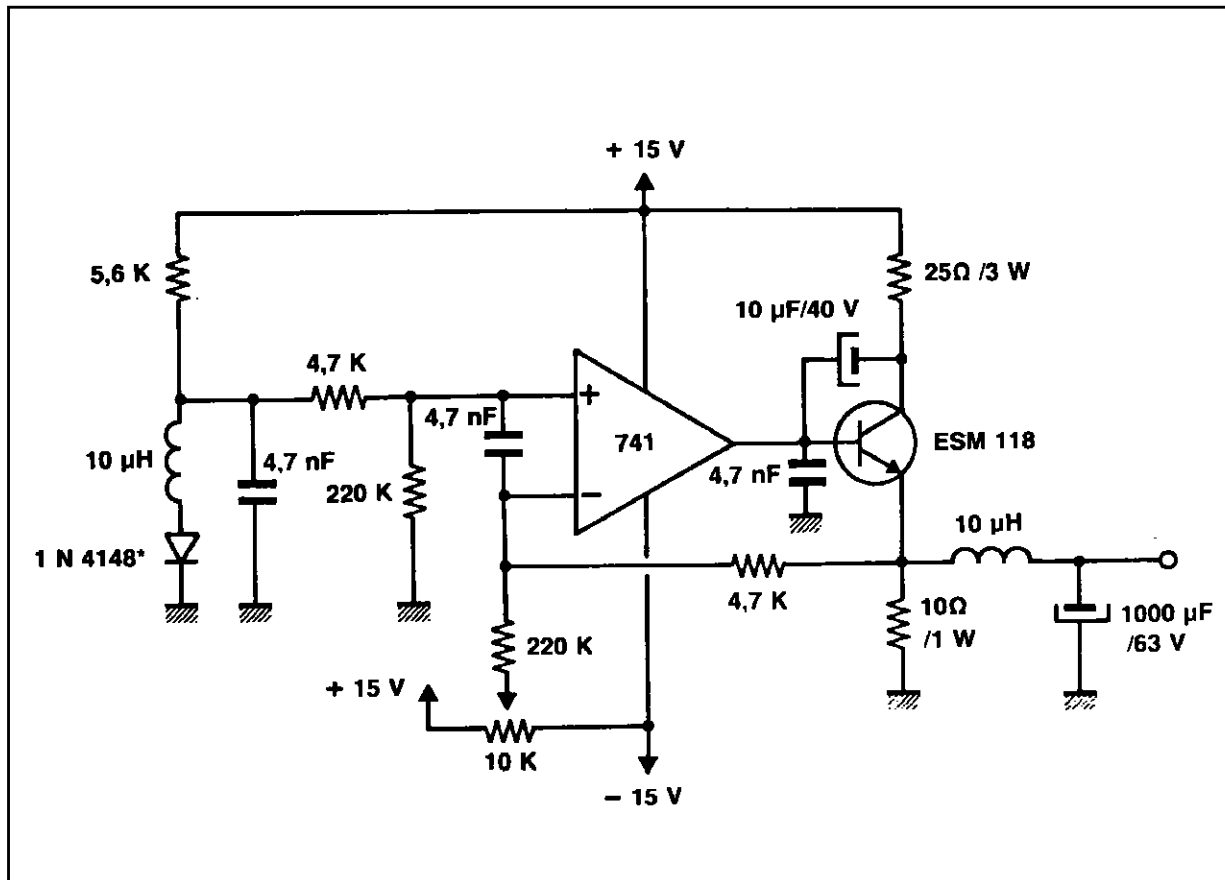

SD1730 (TH560)

PACKAGE MECHANICAL DATA

Ref.: Dwg. No.12-0174 rev. A

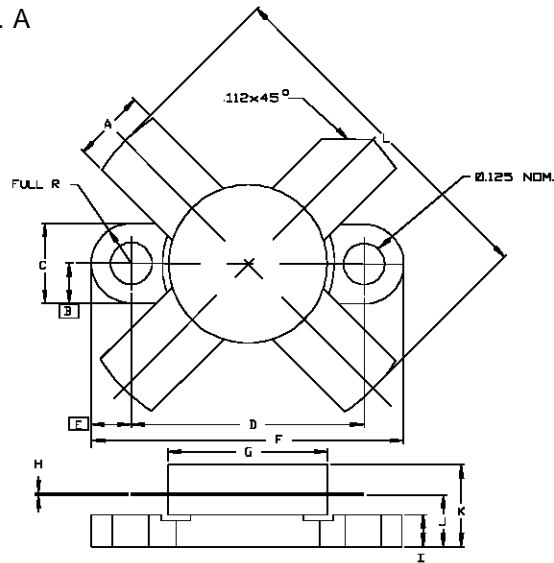

SGS-THOMSON MICROELECTRONICS			CONT'D		
	MINIMUM Inches/mm	MAXIMUM Inches/mm		MINIMUM Inches/mm	MAXIMUM Inches/mm
A	.220/5,59	.230/5,84	K		.280/7,11
B	.125/3,18		L		1.050/26,67
C	.245/6,22	.255/6,48			
D	.720/18,28	.730/18,54			
E	.125/3,18				
F	.970/24,64	.980/24,89			
G	.495/12,57	.505/12,83			
H	.003/0,08	.007/0,18			
I	.090/2,29	.110/2,79			
J	.160/4,06	.175/4,45			

Information furnished is believed to be accurate and reliable. However, SGS-THOMSON Microelectronics assumes no responsibility for the consequences of use of such information nor for any infringement of patents or other rights of third parties which may result from its use. No license is granted by implication or otherwise under any patent or patent rights of SGS-THOMSON Microelectronics. Specifications mentioned in this publication are subject to change without notice. This publication supersedes and replaces all information previously supplied. SGS-THOMSON Microelectronics products are not authorized for use as critical components in life support devices or systems without express written approval of SGS-THOMSON Microelectronics.

©1994 SGS-THOMSON Microelectronics - All Rights Reserved

SGS-THOMSON Microelectronics GROUP OF COMPANIES

Australia - Brazil - France - Germany - Hong Kong - Italy - Japan - Korea - Malaysia - Malta - Morocco - The Netherlands - Singapore - Spain - Sweden - Switzerland - Taiwan - Thailand - United Kingdom - U.S.A.