

Fast Recovery Diodes (Hockey PUK Version), 350 A

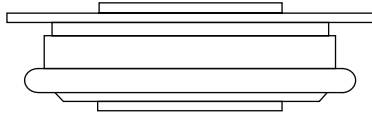

DO-200AA

PRODUCT SUMMARY

$I_{F(AV)}$	350 A
-------------	-------

FEATURES

- High power FAST recovery diode series
- 1.0 to 2.0 μ s recovery time
- High voltage ratings up to 2500 V
- High current capability
- Optimized turn-on and turn-off characteristics
- Low forward recovery
- Fast and soft reverse recovery
- Press PUK encapsulation
- Case style conform to JEDEC DO-200AA
- Maximum junction temperature 125 °C
- Lead (Pb)-free



RoHS
COMPLIANT

TYPICAL APPLICATIONS

- Snubber diode for GTO
- High voltage freewheeling diode
- Fast recovery rectifier applications

MAJOR RATINGS AND CHARACTERISTICS

PARAMETER	TEST CONDITIONS	VALUES	UNITS
$I_{F(AV)}$		350	A
	T_{hs}	55	°C
$I_{F(RMS)}$		550	A
	T_{hs}	25	°C
I_{FSM}	50 Hz	5770	A
	60 Hz	6040	
I^2t	50 Hz	166	kA ² s
	60 Hz	152	
V_{RRM}	Range	400 to 2500	V
t_{rr}		1.0 to 2.0	μ s
	T_J	25	°C
T_J		- 40 to 125	

ELECTRICAL SPECIFICATIONS

VOLTAGE RATINGS				
TYPE NUMBER	VOLTAGE CODE	V _{RRM} , MAXIMUM REPETITIVE PEAK AND OFF-STATE VOLTAGE V	V _{RSM} , MAXIMUM NON-REPETITIVE PEAK REVERSE VOLTAGE V	I _{RRM} MAXIMUM AT T _J = 125 °C mA
SD303C..S10C	04	400	500	35
	08	800	900	
	10	1000	1100	
SD303C..S15C	12	1200	1300	
	14	1400	1500	
	16	1600	1700	
SD303C..S20C	20	2000	2100	
	25	2500	2600	

FORWARD CONDUCTION					
PARAMETER	SYMBOL	TEST CONDITIONS		VALUES	UNITS
Maximum average forward current at heatsink temperature	I _{F(AV)}	180° conduction, half sine wave		350 (175)	A
		Double side (single side) cooled		55 (75)	°C
Maximum RMS current	I _{F(RMS)}	25 °C heatsink temperature double side cooled		550	A
Maximum peak, one-cycle, non-repetitive forward current	I _{FSM}	t = 10 ms	No voltage reapplied	5770	
		t = 8.3 ms	No voltage reapplied	6040	
		t = 10 ms	100 % V _{RRM} reapplied	4850	
		t = 8.3 ms	100 % V _{RRM} reapplied	5080	
Maximum I ² t for fusing	I ² t	t = 10 ms	No voltage reapplied	166	kA ² s
		t = 8.3 ms	No voltage reapplied	152	
		t = 10 ms	100 % V _{RRM} reapplied	117	
		t = 8.3 ms	100 % V _{RRM} reapplied	107	
Maximum I ² √t for fusing	I ² √t	t = 0.1 to 10 ms, no voltage reapplied		1660	kA ² /s
Low level value of threshold voltage	V _{F(TO)1}	(16.7 % × π × I _{F(AV)}) < I < π × I _{F(AV)} , T _J = T _J maximum		1.14	V
High level value of threshold voltage	V _{F(TO)2}	(I > π × I _{F(AV)}), T _J = T _J maximum		1.63	
Low level of forward slope resistance	r _{f1}	(16.7 % × π × I _{F(AV)}) < I < π × I _{F(AV)} , T _J = T _J maximum		1.14	mΩ
High level of forward slope resistance	r _{f2}	(I > π × I _{F(AV)}), T _J = T _J maximum		0.77	
Maximum forward voltage drop	V _{FM}	I _{pk} = 1100 A, T _J = 25 °C; t _p = 10 ms sinusoidal wave		2.26	V

RECOVERY CHARACTERISTICS								
CODE	MAXIMUM VALUE AT T _J = 25 °C	TEST CONDITIONS			TYPICAL VALUES AT T _J = 125 °C			
	t _{rr} AT 25 % I _{RRM} (μs)	I _{pk} SQUARE PULSE (A)	di/dt (A/μs)	V _r (V)	t _{rr} AT 25 % I _{RRM} (μs)	Q _{rr} (μC)	I _{rr} (A)	
S10	1.0	750	25	- 30	2.4	52	33	
S15	1.5				2.9	90	44	
S20	2.0				3.2	107	46	



THERMAL AND MECHANICAL SPECIFICATIONS				
PARAMETER	SYMBOL	TEST CONDITIONS	VALUES	UNITS
Maximum operating temperature range	T_J		- 40 to 125	°C
Maximum storage temperature range	T_{Stg}		- 40 to 150	
Maximum thermal resistance, junction to heatsink	R_{thJ-hs}	DC operation single side cooled	0.16	K/W
		DC operation double side cooled	0.08	
Mounting force, $\pm 10\%$			4900 (500)	N (kg)
Approximate weight			70	g
Case style		See dimensions - link at the end of datasheet	DO-200AA	

ΔR_{thJ-hs} CONDUCTION						
CONDUCTION ANGLE	SINUSOIDAL CONDUCTION		RECTANGULAR CONDUCTION		TEST CONDITIONS	UNITS
	SINGLE SIDE	DOUBLE SIDE	SINGLE SIDE	DOUBLE SIDE		
180°	0.010	0.011	0.008	0.008	$T_J = T_J$ maximum	K/W
120°	0.012	0.013	0.013	0.013		
90°	0.016	0.016	0.018	0.018		
60°	0.024	0.024	0.025	0.025		
30°	0.042	0.042	0.042	0.042		

Note

- The table above shows the increment of thermal resistance R_{thJ-hs} when devices operate at different conduction angles than DC

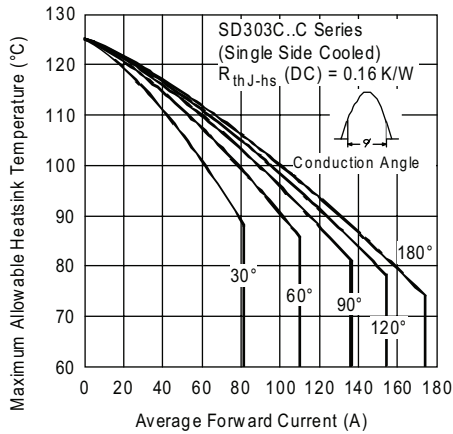

Fig. 1 - Current Ratings Characteristics

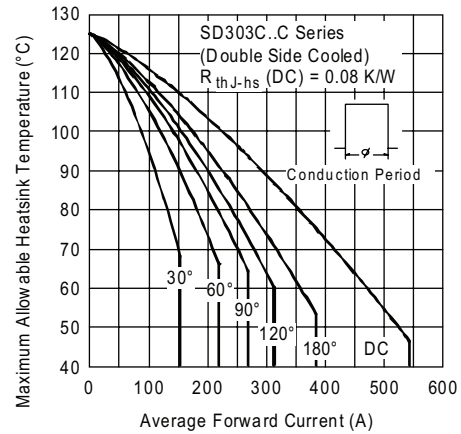

Fig. 4 - Current Ratings Characteristics

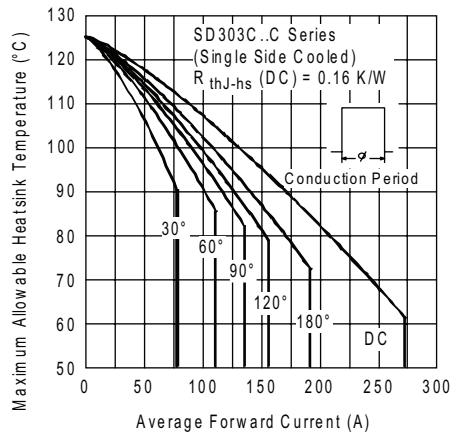

Fig. 2 - Current Ratings Characteristics

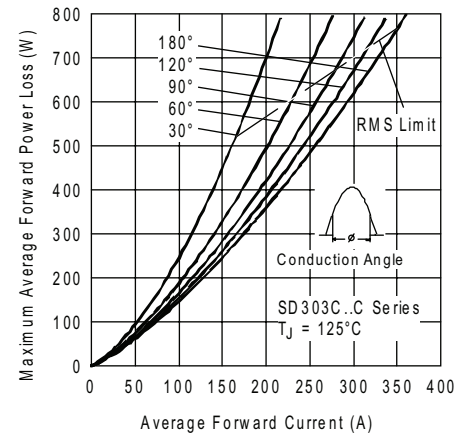

Fig. 5 - Forward Power Loss Characteristics

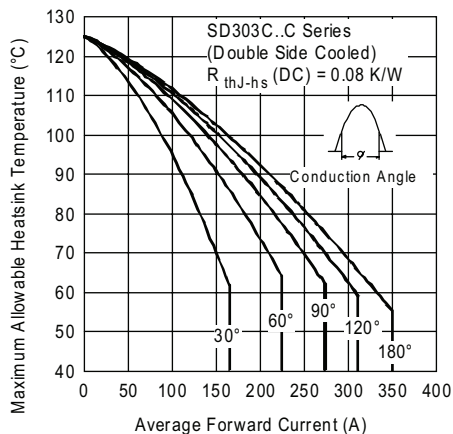

Fig. 3 - Current Ratings Characteristics

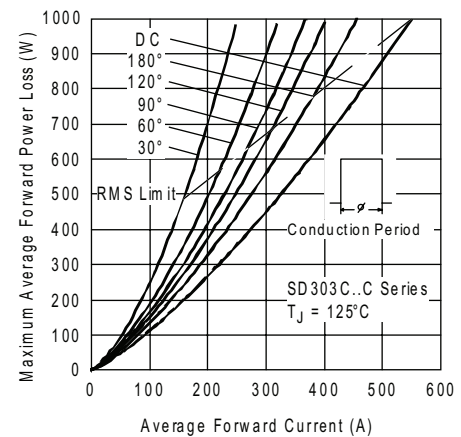

Fig. 6 - Forward Power Loss Characteristics

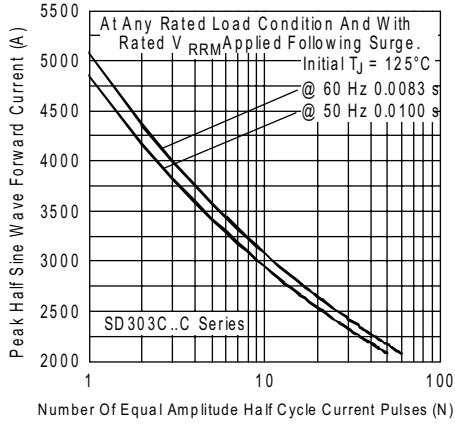

Fig. 7 - Maximum Non-Repetitive Surge Current Single and Double Side Cooled

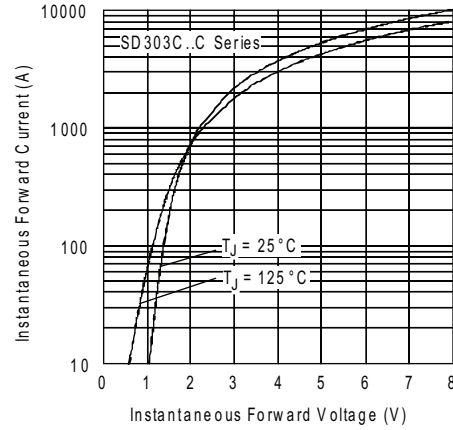

Fig. 9 - Forward Voltage Drop Characteristics

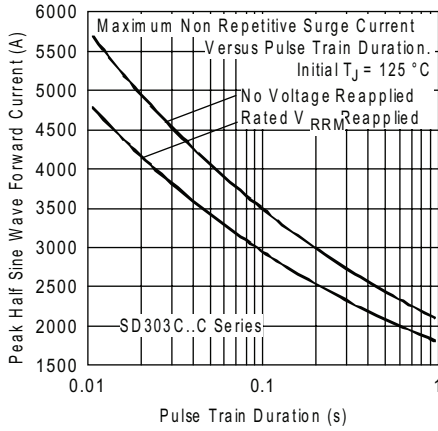

Fig. 8 - Maximum Non-Repetitive Surge Current Single and Double Side Cooled

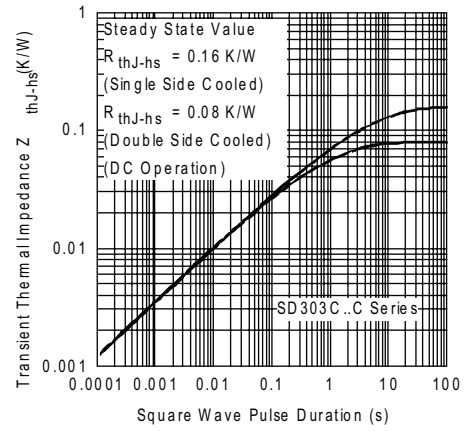

Fig. 10 - Thermal Impedance Z_{thJ-hs} Characteristic

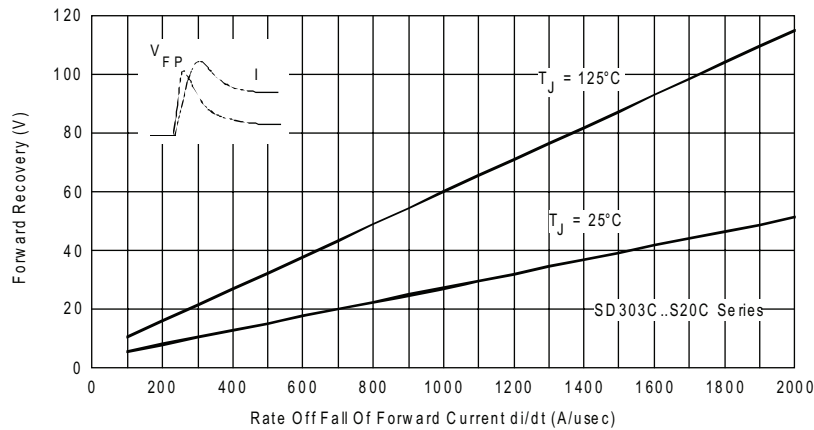

Fig. 11 - Typical Forward Recovery Characteristics

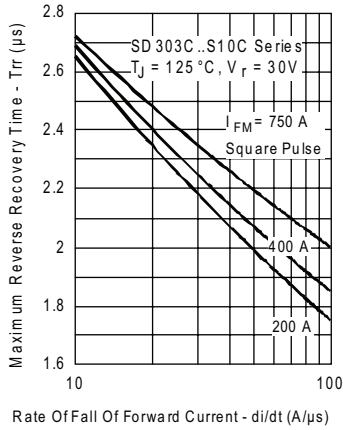

Fig. 12 - Recovery Time Characteristics

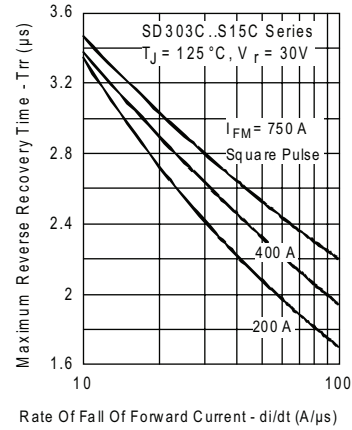

Fig. 15 - Recovery Time Characteristics

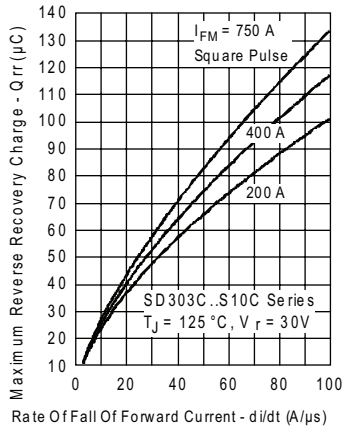

Fig. 13 - Recovery Charge Characteristics

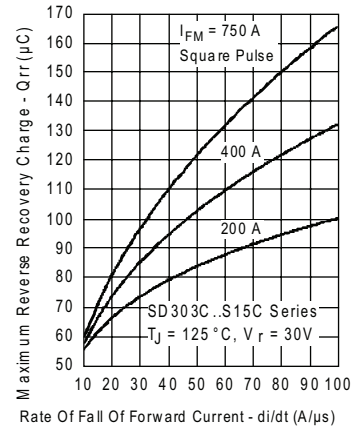

Fig. 16 - Recovery Charge Characteristics

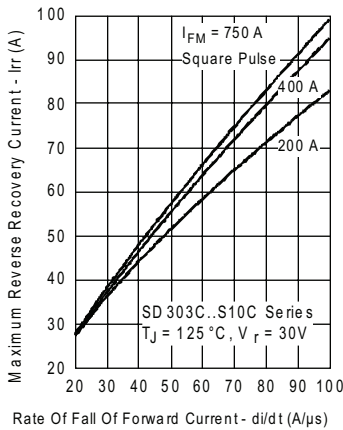

Fig. 14 - Recovery Current Characteristics

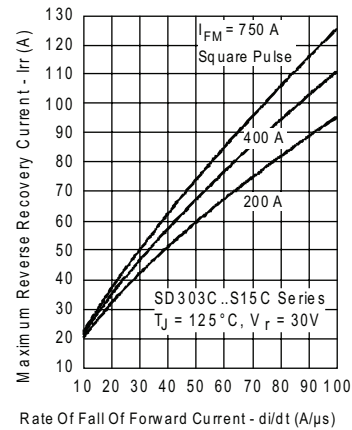

Fig. 17 - Recovery Current Characteristics



Fast Recovery Diodes (Hockey PUK Version), 350 A **Vishay High Power Products**

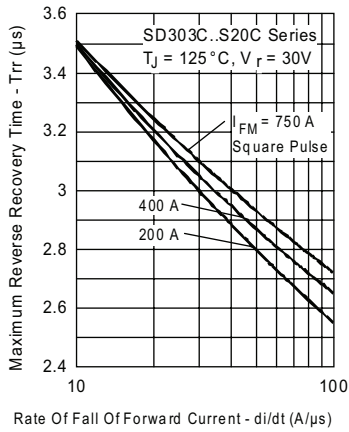

Fig. 18 - Recovery Time Characteristics

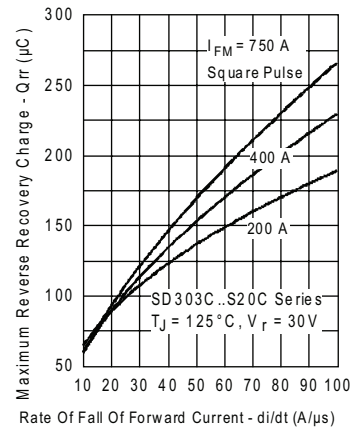

Fig. 19 - Recovery Charge Characteristics

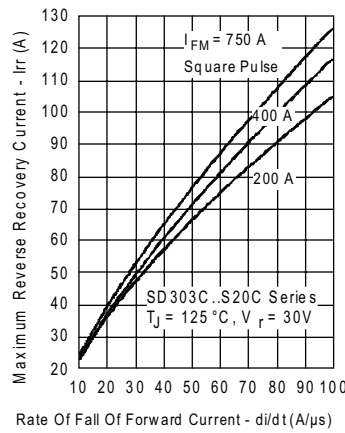

Fig. 20 - Recovery Current Characteristics

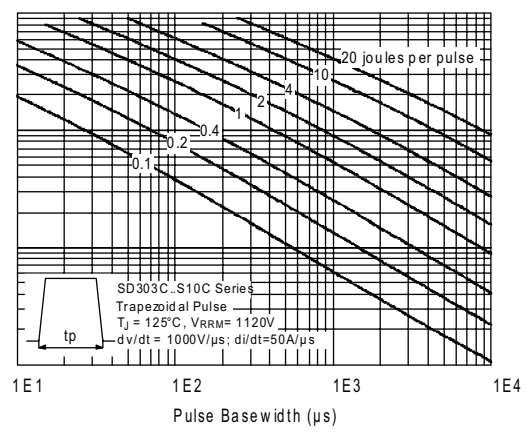
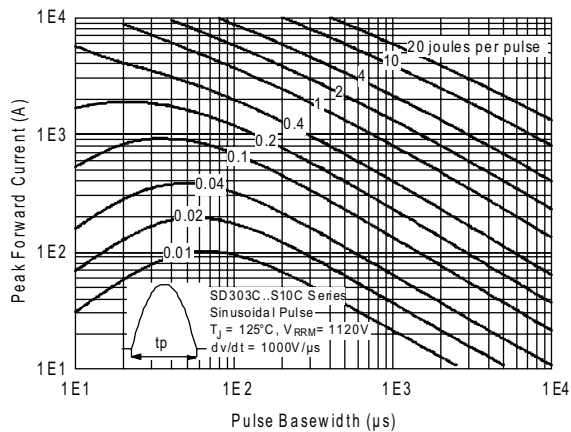

Fig. 21 - Maximum Total Energy Loss Per Pulse Characteristics

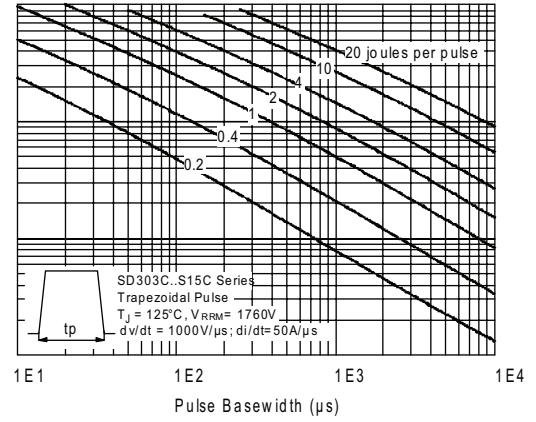
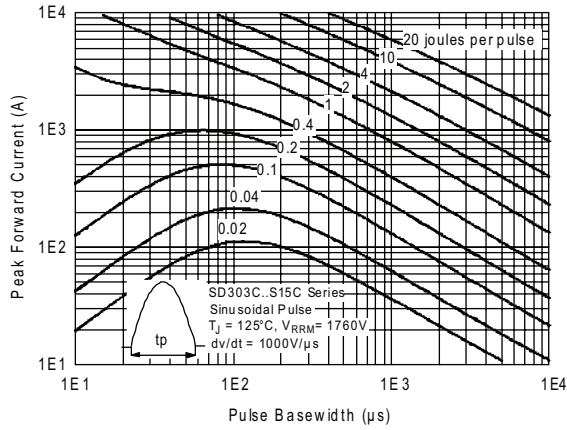

Fig. 22 - Maximum Total Energy Loss Per Pulse Characteristics

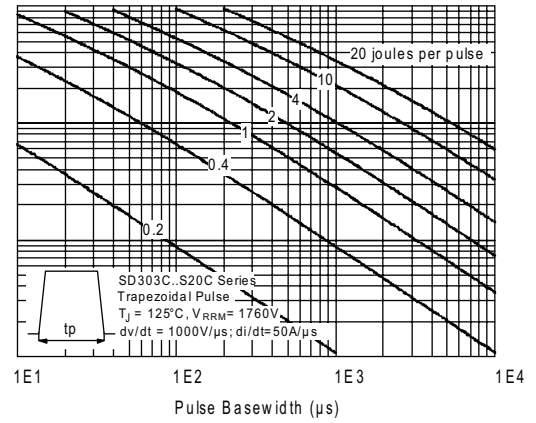
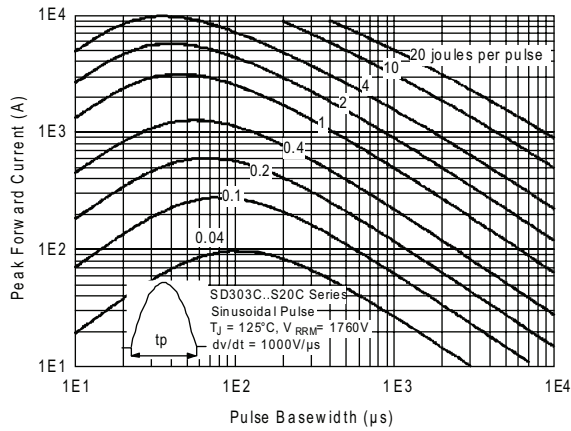

Fig. 23 - Maximum Total Energy Loss Per Pulse Characteristics



ORDERING INFORMATION TABLE

Device code	SD	30	3	C	25	S20	C
	①	②	③	④	⑤	⑥	⑦

- 1** - Diode
- 2** - Essential part number
- 3** - 3 = Fast recovery
- 4** - C = Ceramic PUK
- 5** - Voltage code x 100 = V_{RRM} (see Voltage Ratings table)
- 6** - t_{rr} code (see Recovery Characteristics table)
- 7** - C = PUK case DO-200AA

LINKS TO RELATED DOCUMENTS	
Dimensions	http://www.vishay.com/doc?95248



Disclaimer

All product specifications and data are subject to change without notice.

Vishay Intertechnology, Inc., its affiliates, agents, and employees, and all persons acting on its or their behalf (collectively, "Vishay"), disclaim any and all liability for any errors, inaccuracies or incompleteness contained herein or in any other disclosure relating to any product.

Vishay disclaims any and all liability arising out of the use or application of any product described herein or of any information provided herein to the maximum extent permitted by law. The product specifications do not expand or otherwise modify Vishay's terms and conditions of purchase, including but not limited to the warranty expressed therein, which apply to these products.

No license, express or implied, by estoppel or otherwise, to any intellectual property rights is granted by this document or by any conduct of Vishay.

The products shown herein are not designed for use in medical, life-saving, or life-sustaining applications unless otherwise expressly indicated. Customers using or selling Vishay products not expressly indicated for use in such applications do so entirely at their own risk and agree to fully indemnify Vishay for any damages arising or resulting from such use or sale. Please contact authorized Vishay personnel to obtain written terms and conditions regarding products designed for such applications.

Product names and markings noted herein may be trademarks of their respective owners.