

### FAST RECOVERY DIODES

### Hockey Puk Version

#### Features

- High power FAST recovery diode series
- 6.0  $\mu$ s recovery time
- High voltage ratings up to 4500V
- High current capability
- Optimized turn on and turn off characteristics
- Low forward recovery
- Fast and soft reverse recovery
- Press-puk encapsulation
- Case style conform to JEDEC DO-200AB (B-PUK)
- Maximum junction temperature 125°C

#### Typical Applications

- Snubber diode for GTO
- High voltage free-wheeling diode
- Fast recovery rectifier applications

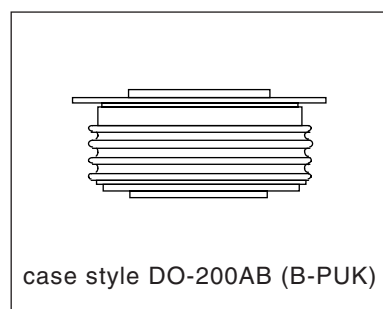
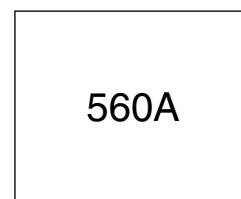

#### Major Ratings and Characteristics

Parameters	SD553C..S50L	Units	
$I_{F(AV)}$	560	A	
@ $T_{hs}$	55	°C	
$I_{F(RMS)}$	1120	A	
@ $T_{hs}$	25	°C	
$I_{FSM}$	@ 50Hz	12000	A
	@ 60Hz	12570	A
$i^2t$	@ 50Hz	721	KA <sup>2</sup> s
	@ 60Hz	658	KA <sup>2</sup> s
$V_{RRM}$ range	3000 to 4500	V	
$t_{rr}$	6.0	$\mu$ s	
@ $T_J$	125	°C	
$T_J$	- 40 to 125	°C	

## SD553C..S50L Series

Bulletin I2092 rev. C 04/00

International  
**IR** Rectifier

### ELECTRICAL SPECIFICATIONS

#### Voltage Ratings

Type number	Voltage Code	$V_{RRM}$ , maximum repetitive peak reverse voltage V	$V_{RSM}$ , maximum non-repetitive peak rev. voltage V	$I_{RRM}$ max. @ $T_J = 125^\circ\text{C}$ mA
SD553C..S50L	30	3000	3100	75
	36	3600	3700	
	40	4000	4100	
	45	4500	4600	

#### Forward Conduction

Parameter	SD553C..S50L	Units	Conditions
$I_{F(AV)}$ Max. average forward current @ Heatsink temperature	560 (210)	A	180° conduction, half sine wave
	55 (85)	°C	Double side (single side) cooled
$I_{F(RMS)}$ Max. RMS forward current	1120	A	@ 25°C heatsink temperature double side cooled
$I_{FSM}$ Max. peak, one-cycle forward, non-repetitive surge current	12000	A	t = 10ms No voltage reappplied
	12570		t = 8.3ms reappplied
	10100		t = 10ms 50% $V_{RRM}$ reappplied
	10570		t = 8.3ms reappplied
$I^2t$ Maximum $I^2t$ for fusing	721	KA <sup>2</sup> s	t = 10ms No voltage reappplied
	658		t = 8.3ms reappplied
	510		t = 10ms 50% $V_{RRM}$ reappplied
	466		t = 8.3ms reappplied
$I^2/t$ Maximum $I^2/t$ for fusing	7210	KA <sup>2</sup> /s	t = 0.1 to 10ms, no voltage reappplied
$V_{F(TO)1}$ Low level value of threshold voltage	1.77	V	$(16.7\% \times \pi \times I_{F(AV)} < I < \pi \times I_{F(AV)})$ , $T_J = T_J$ max.
$V_{F(TO)2}$ High level value of threshold voltage	1.95		$(I > \pi \times I_{F(AV)})$ , $T_J = T_J$ max.
$r_{f1}$ Low level value of forward slope resistance	0.98	mΩ	$(16.7\% \times \pi \times I_{F(AV)} < I < \pi \times I_{F(AV)})$ , $T_J = T_J$ max.
$r_{f2}$ High level value of forward slope resistance	0.89		$(I > \pi \times I_{F(AV)})$ , $T_J = T_J$ max.
$V_{FM}$ Max. forward voltage drop	3.24	V	$I_{pk} = 1500\text{A}$ , $T_J = 125^\circ\text{C}$ , $t_p = 10\text{ms}$ sinusoidal wave

#### Recovery Characteristics

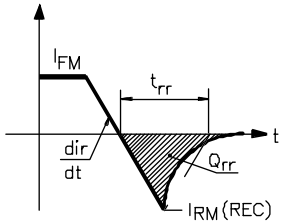
Code	$T_J = 25^\circ\text{C}$ Typical $t_{rr}$ @ 25% $I_{RRM}$ (μs)	Test conditions			Max. values @ $T_J = 125^\circ\text{C}$			
		$I_{pk}$ Square Pulse (A)	$di/dt$ (A/μs)	$V_r$ (V)	$t_{rr}$ @ 25% $I_{RRM}$ (μs)	$Q_{rr}$ (μC)	$I_{rr}$ (A)	
S50	5.0	1000	100	-50	6.0	900	250	

**Thermal and Mechanical Specifications**

Parameter	SD553C..S50L	Units	Conditions
T <sub>J</sub> Max. junction operating temperature range	-40 to 125	°C	
T <sub>stg</sub> Max. storage temperature range	-40 to 150		
R <sub>thJ-hs</sub> Max. thermal resistance, junction to heatsink	0.073 0.031	K/W	DC operation single side cooled DC operation double side cooled
F Mounting force, ± 10%	14700 (1500)	N (Kg)	
wt Approximate weight	255	g	
Case style	DO-200AB (B-PUK)		Conforms to JEDEC

**ΔR<sub>thJ-hs</sub> Conduction**

(The following table shows the increment of thermal resistance R<sub>thJ-hs</sub> when devices operate at different conduction angles than DC)

Conduction angle	Sinusoidal conduction		Rectangular conduction		Units	Conditions
	Single Side	Double Side	Single Side	Double Side		
180°	0.009	0.009	0.006	0.006	K/W	T <sub>J</sub> = T <sub>J</sub> max.
120°	0.011	0.011	0.011	0.011		
90°	0.014	0.014	0.015	0.015		
60°	0.020	0.020	0.021	0.021		
30°	0.036	0.036	0.036	0.036		

**Ordering Information Table**

**Device Code**

SD	55	3	C	45	S50	L
①	②	③	④	⑤	⑥	⑦

- 1** - Diode
- 2** - Essential part number
- 3** - 3 = Fast recovery
- 4** - C = Ceramic Puk
- 5** - Voltage code: Code x 100 = V<sub>RRM</sub> (See Voltage Ratings table)
- 6** - t<sub>rr</sub> code
- 7** - L = Puk Case DO-200AB (B-PUK)

# SD553C..S50L Series

Bulletin I2092 rev. C 04/00

International  
**IRF** Rectifier

## Outline Table

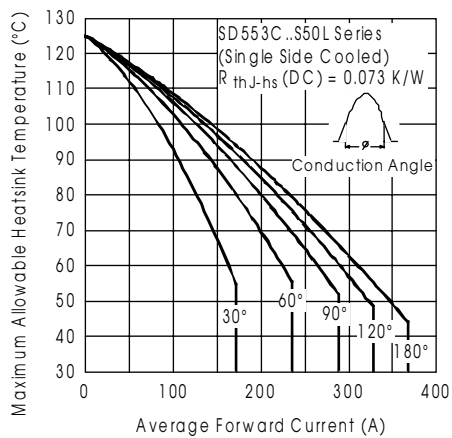
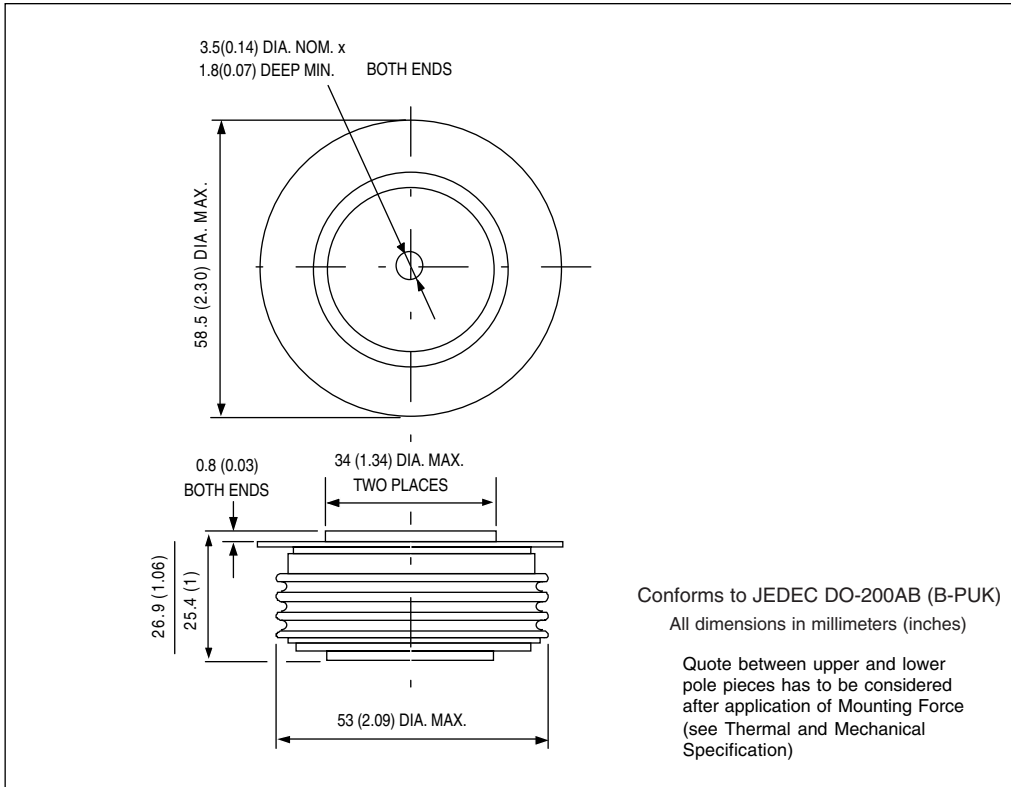

Fig. 1 - Current Ratings Characteristics

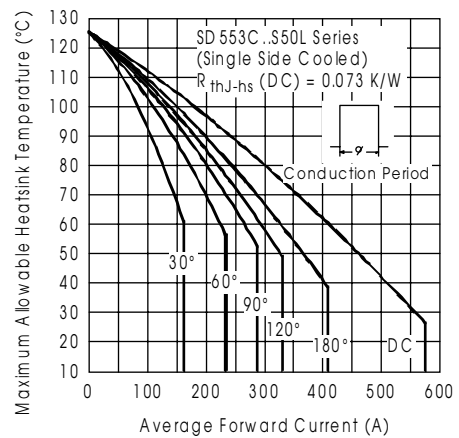

Fig. 2 - Current Ratings Characteristics

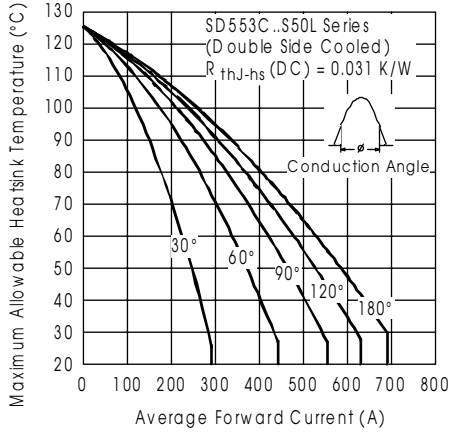

Fig. 3 - Current Ratings Characteristics

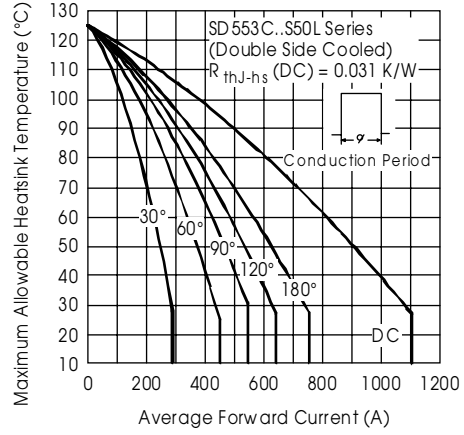

Fig. 4 - Current Ratings Characteristics

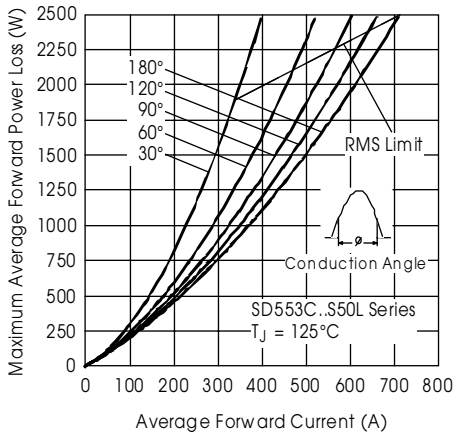

Fig. 5 - Forward Power Loss Characteristics

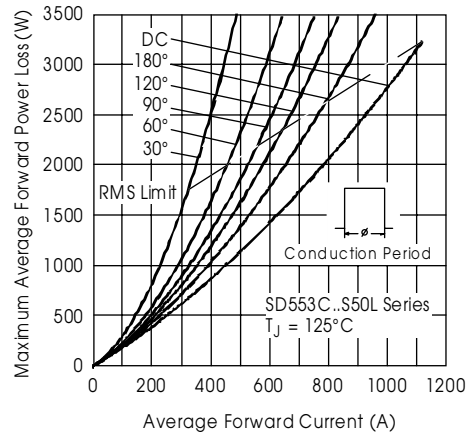

Fig. 6 - Forward Power Loss Characteristics

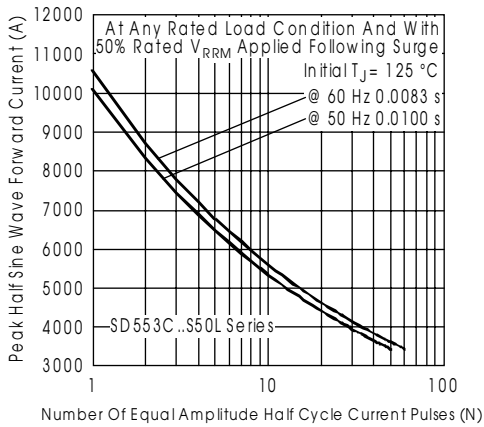

Fig. 7 - Maximum Non-repetitive Surge Current  
Single and Double Side Cooled

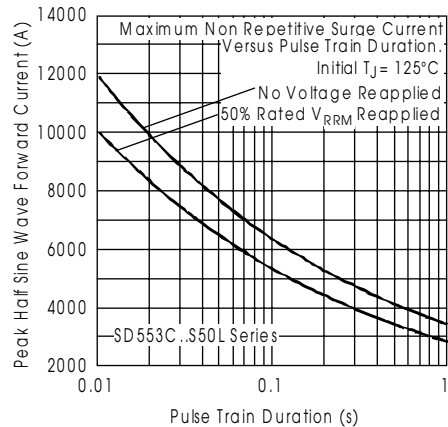

Fig. 8 - Maximum Non-repetitive Surge Current  
Single and Double Side Cooled

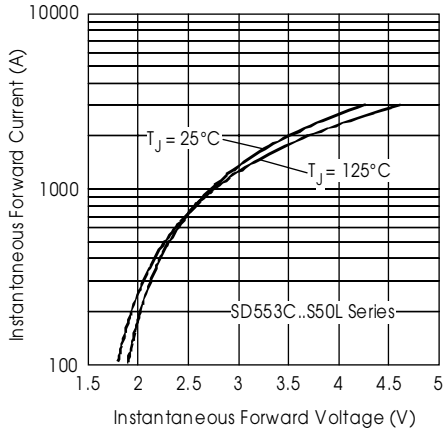

Fig. 9 - Forward Voltage Drop Characteristics

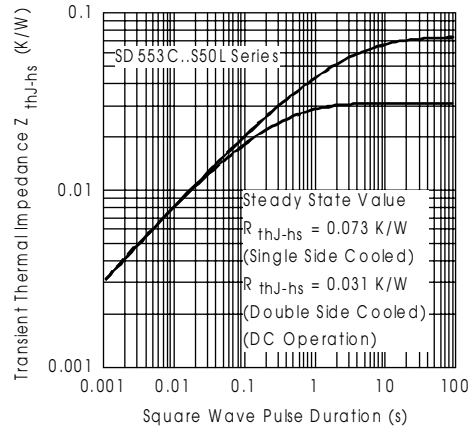

Fig. 10 - Thermal Impedance  $Z_{thj-hs}$  Characteristic

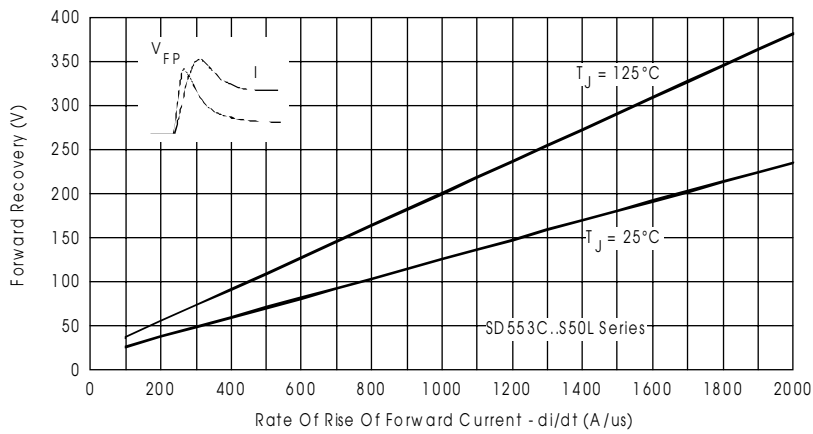

Fig. 11 - Typical Forward Recovery Characteristics

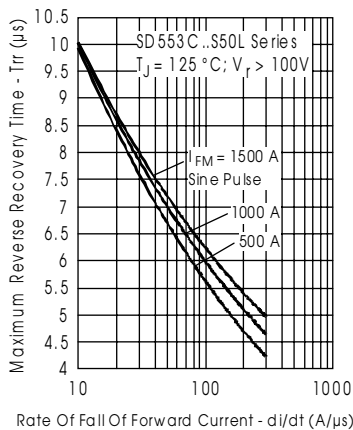

Fig. 12 - Recovery Time Characteristics

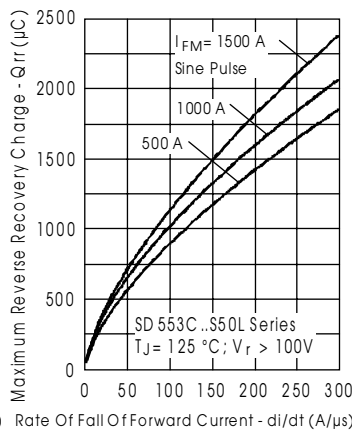

Fig. 13 - Recovery Charge Characteristics

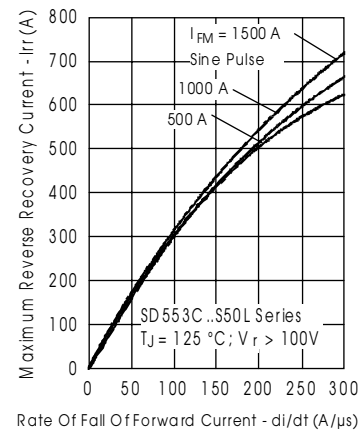

Fig. 14 - Recovery Current Characteristics

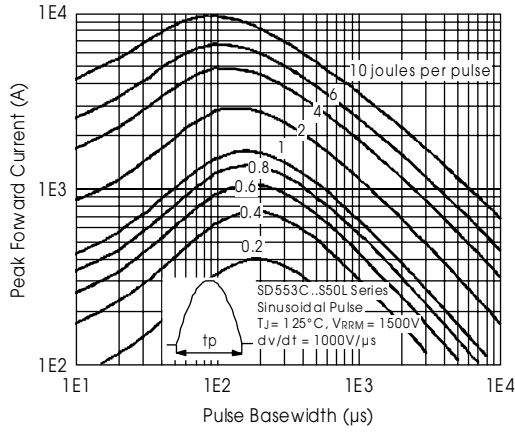

Fig. 15 - Maximum Total Energy Loss Per Pulse Characteristics

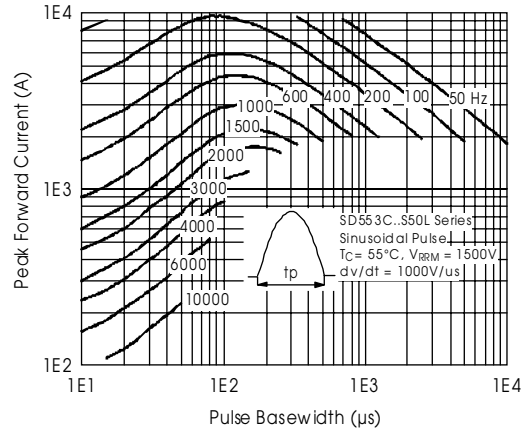

Fig. 16 - Frequency Characteristics

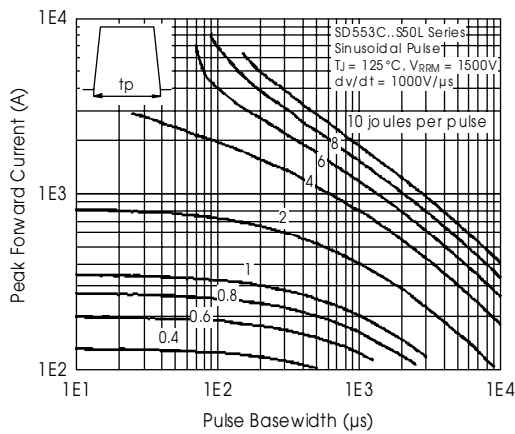

Fig. 17 - Maximum Total Energy Loss Per Pulse Characteristics

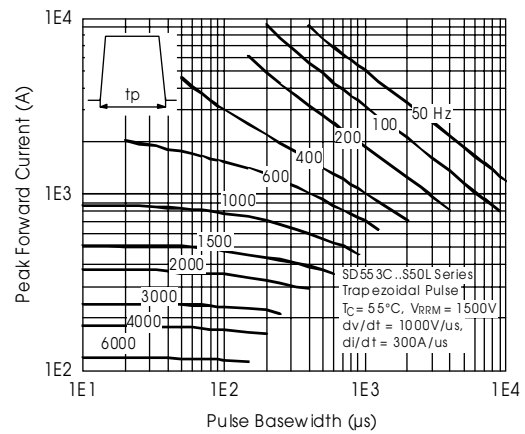

Fig. 18 - Frequency Characteristics

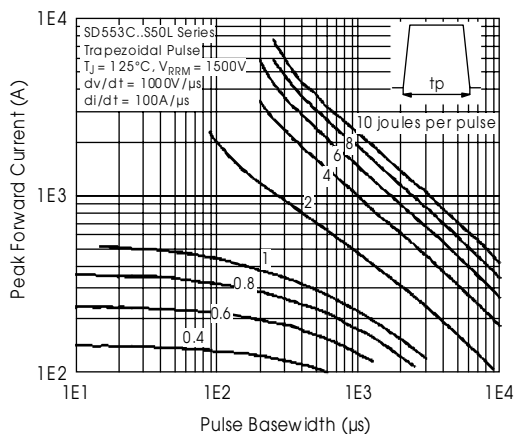

Fig. 19 - Maximum Total Energy Loss Per Pulse Characteristics

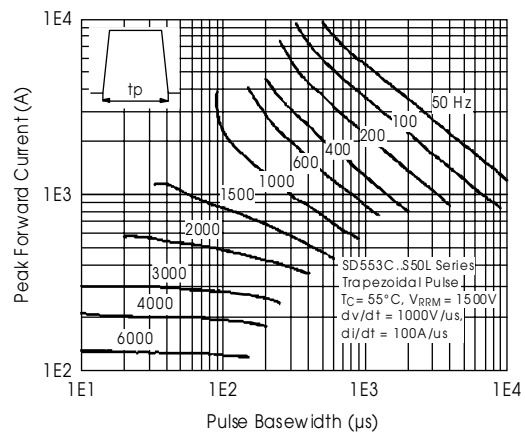

Fig. 20 - Frequency Characteristics