

FAST RECOVERY DIODES

Hockey Puk Version

Features

- High power FAST recovery diode series
- 1.0 to 1.5 μ s recovery time
- High voltage ratings up to 1600V
- High current capability
- Optimized turn on and turn off characteristics
- Low forward recovery
- Fast and soft reverse recovery
- Press-puk encapsulation
- Case style conform to JEDEC B-43
- Maximum junction temperature 125°C

Typical Applications

- Snubber diode for GTO
- High voltage free-wheeling diode
- Fast recovery rectifier applications

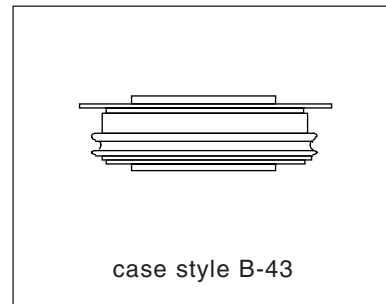
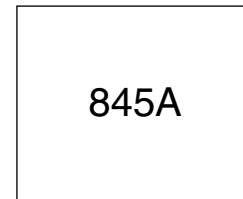

Major Ratings and Characteristics

Parameters	SD803C..C	Units
$I_{F(AV)}$	845	A
@ T_{hs}	55	°C
$I_{F(RMS)}$	1326	A
@ T_{hs}	25	°C
I_{FSM}	@ 50Hz 11295	A
	@ 60Hz 11830	A
I^2t	@ 50Hz 640	KA ² s
	@ 60Hz 583	KA ² s
V_{RRM} range	400 to 1600	V
t_{rr} range	1.0 to 1.5	μ s
@ T_J	25	°C
T_J	- 40 to 125	°C

SD803C..C Series

Bulletin I2069 rev.B 04/00

International
IR Rectifier

ELECTRICAL SPECIFICATIONS

Voltage Ratings

Type number	Voltage Code	V_{RRM} max. repetitive peak and off-state voltage V	V_{RSM} , maximum non-repetitive peak voltage V	I_{RRM} max. $T_J = 125^\circ\text{C}$ mA
SD803C..S10C	04	400	500	45
	08	800	900	
	10	1000	1100	
SD803C..S15C	12	1200	1300	
	14	1400	1500	
	16	1600	1700	

Forward Conduction

Parameter	SD803C..C	Units	Conditions
$I_{F(AV)}$ Max. average forward current @ Heatsink temperature	845(420)	A	180° conduction, half sine wave.
	55(75)	°C	Double side (single side) cooled
$I_{F(RMS)}$ Max. RMS current	1326	A	@ 25°C heatsink temperature double side cooled
I_{FSM} Max. peak, one-cycle non-repetitive forward current	11295	A	t = 10ms No voltage reappplied
	11830		t = 8.3ms reappplied
	9500		t = 10ms 100% V_{RRM} reappplied
	9945		t = 8.3ms reappplied
I^2t Maximum I^2t for fusing	640	KA ² s	t = 10ms No voltage reappplied
	583		t = 8.3ms reappplied
	451		t = 10ms 100% V_{RRM} reappplied
	412		t = 8.3ms reappplied
I^2/t Maximum I^2/t for fusing	6400	KA ² /s	t = 0.1 to 10ms, no voltage reappplied
$V_{F(TO)1}$ Low level of threshold voltage	1.02	V	(16.7% x π x $I_{F(AV)}$) < I < π x $I_{F(AV)}$, $T_J = T_J$ max.
$V_{F(TO)2}$ High level of threshold voltage	1.32		(I > π x $I_{F(AV)}$), $T_J = T_J$ max.
r_{f1} Low level of forward slope resistance	0.38	mΩ	(16.7% x π x $I_{F(AV)}$) < I < π x $I_{F(AV)}$, $T_J = T_J$ max.
r_{f2} High level of forward slope resistance	0.28		(I > π x $I_{F(AV)}$), $T_J = T_J$ max.
V_{FM} Max. forward voltage	1.89	V	$I_{pk} = 2655\text{A}$, $T_J = 25^\circ\text{C}$, $t_p = 10\text{ms}$ sinusoidal wave

Recovery Characteristics

Code	$T_J = 25^\circ\text{C}$ typical t_{rr} @ 25% I_{RRM} (μs)	Test conditions			Max. values @ $T_J = 125^\circ\text{C}$		
		I_{pk} Square Pulse (A)	di/dt (A/μs)	V_r (V)	t_{rr} @ 25% I_{RRM} (μs)	Q_{rr} (μC)	I_{rr} (A)
S10	1.0	1000	25	-30	2.0	45	34
S15	1.5				3.2	87	51

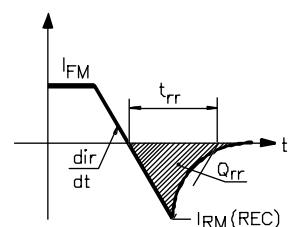

Thermal and Mechanical Specifications

Parameter	SD803C..C	Units	Conditions
T _J Max. operating temperature range	-40 to 125	°C	
T _{stg} Max. storage temperature range	-40 to 150		
R _{thJ-hs} Max. thermal resistance, junction to heatsink	0.076 0.038	K/W	DC operationsingle side cooled DC operationdouble side cooled
F Mounting force, ± 10%	9800 (1000)		N (Kg)
wt Approximate weight	83	g	
Case style	B-43		See Outline Table

ΔR_{thJ-hs} Conduction

(The following table shows the increment of thermal resistance R_{thJ-hs} when devices operate at different conduction angles than DC)

Conduction angle	Sinusoidal conduction		Rectangular conduction		Units	Conditions
	Single Side	Double Side	Single Side	Double Side		
180°	0.006	0.007	0.005	0.005	K/W	T _J = T _J max.
120°	0.008	0.008	0.008	0.008		
90°	0.010	0.010	0.011	0.011		
60°	0.015	0.015	0.016	0.016		
30°	0.026	0.026	0.026	0.026		

Ordering Information Table

Device Code

SD	80	3	C	16	S15	C
①	②	③	④	⑤	⑥	⑦

- 1** - Diode
- 2** - Essential part number
- 3** - 3 = Fast recovery
- 4** - C = Ceramic Puk
- 5** - Voltage code: Code x 100 = V_{RRM} (see Voltage Ratings table)
- 6** - t_{rr} code (see Recovery Characteristics table)
- 7** - C = Puk Case B-43

SD803C..C Series

Bulletin I2069 rev. B 04/00



Outline Table

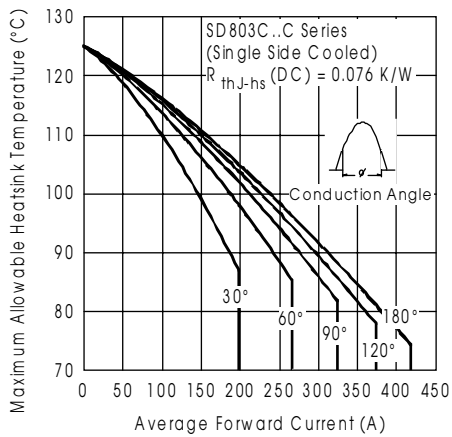
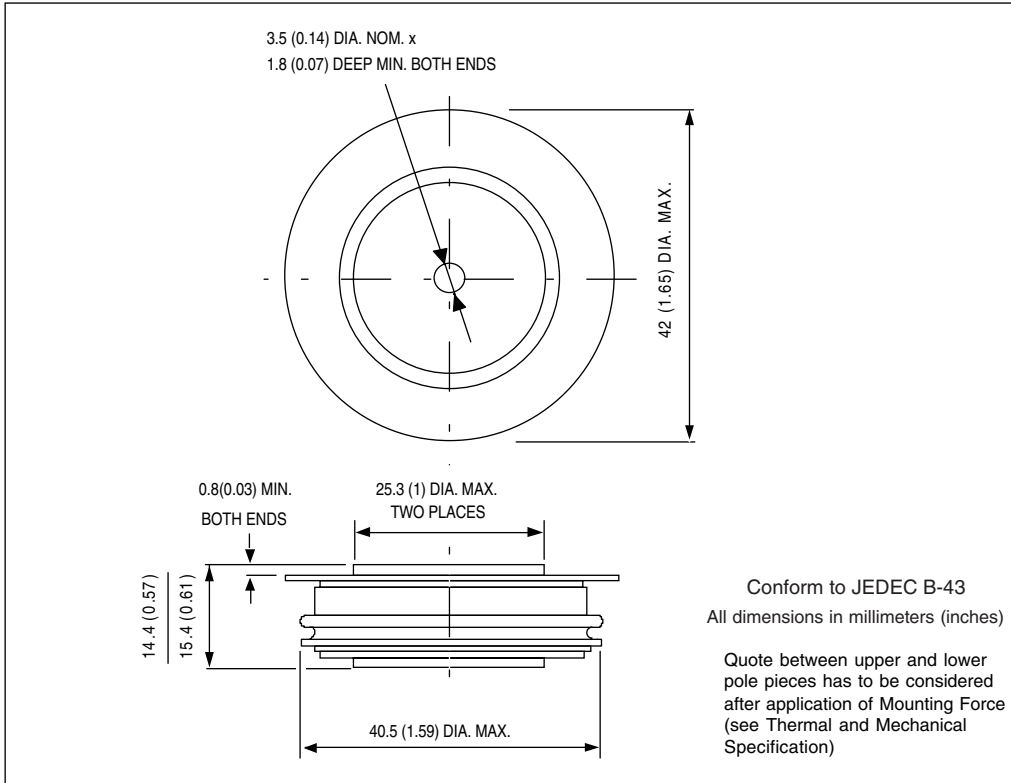

Fig. 1 - Current Ratings Characteristics

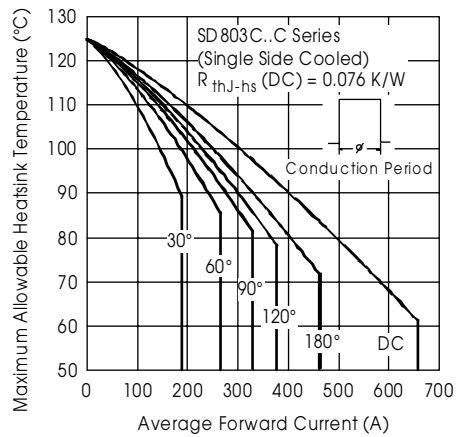

Fig. 2 - Current Ratings Characteristics

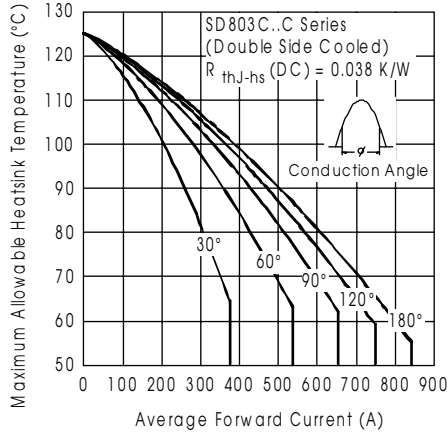

Fig. 3 - Current Ratings Characteristics

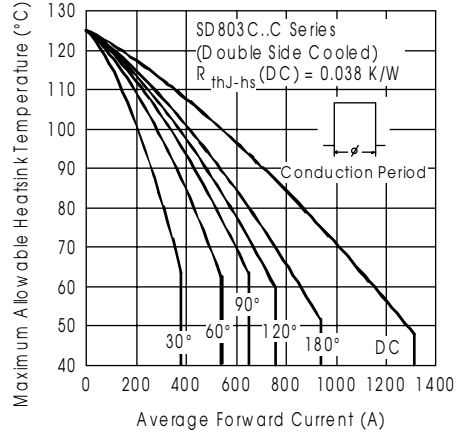

Fig. 4 - Current Ratings Characteristics

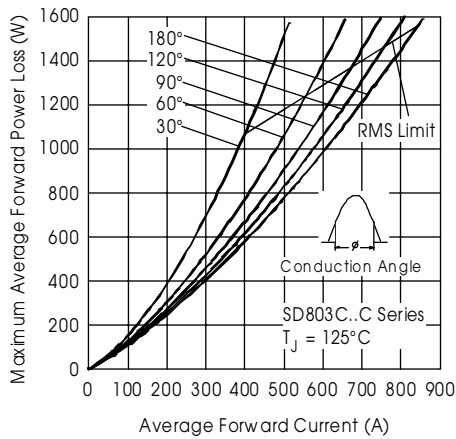

Fig. 5 - Forward Power Loss Characteristics

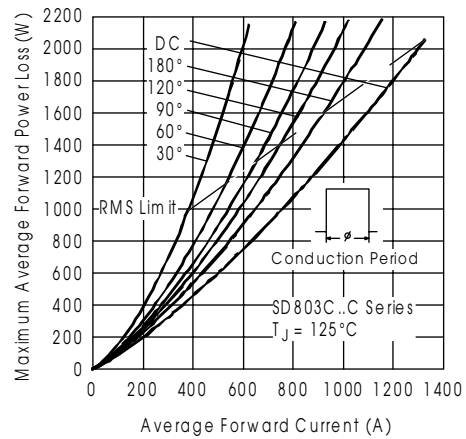

Fig. 6 - Forward Power Loss Characteristics

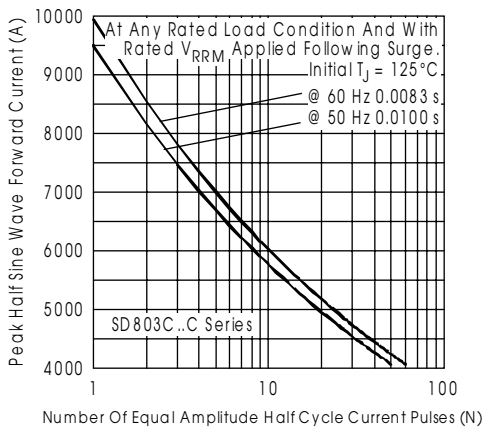

Fig. 7 - Maximum Non-repetitive Surge Current Single and Double Side Cooled

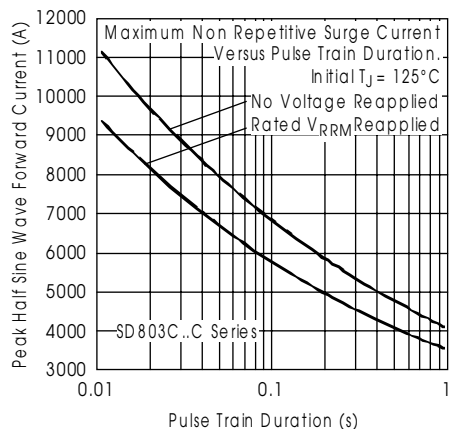

Fig. 8 - Maximum Non-repetitive Surge Current Single and Double Side Cooled

SD803C..C Series

Bulletin I2069 rev. B 04/00

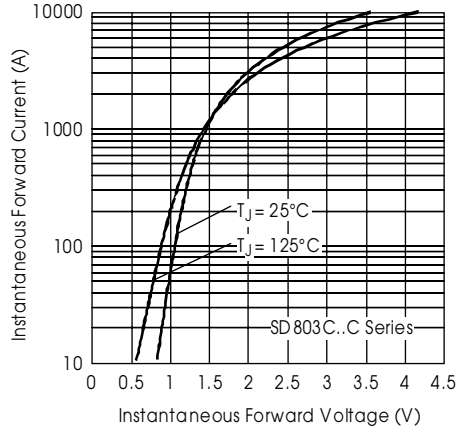

Fig. 9 - Forward Voltage Drop Characteristics

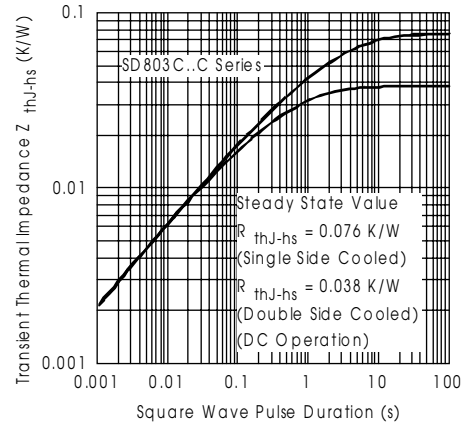

Fig. 10 - Thermal Impedance Z_{thJ-hs} Characteristic

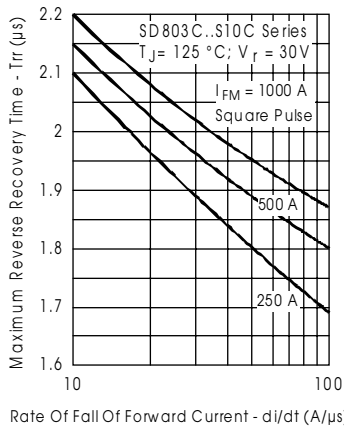

Fig. 11 - Recovery Time Characteristics

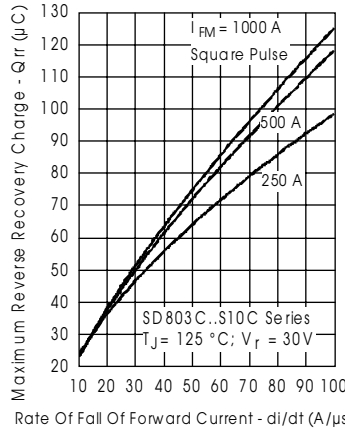

Fig. 12 - Recovery Charge Characteristics

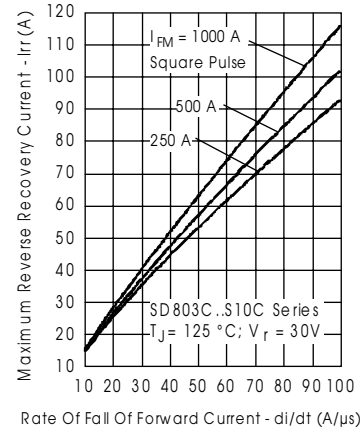

Fig. 13 - Recovery Current Characteristics

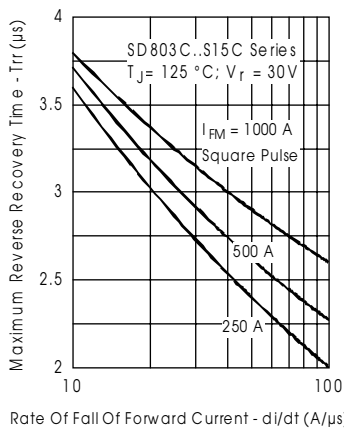

Fig. 14 - Recovery Time Characteristics

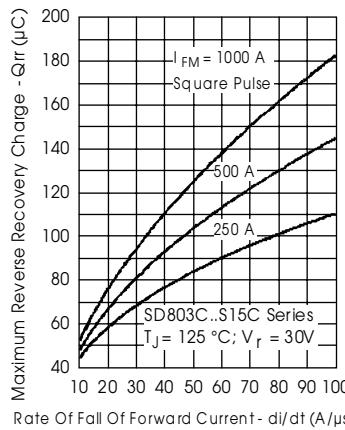

Fig. 15 - Recovery Charge Characteristics

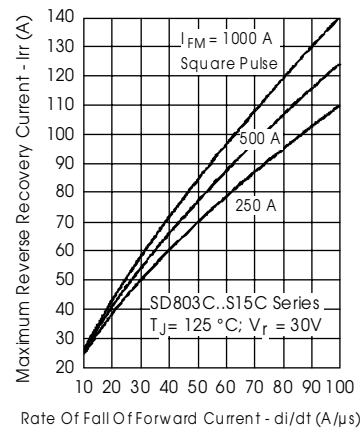

Fig. 16 - Recovery Current Characteristics

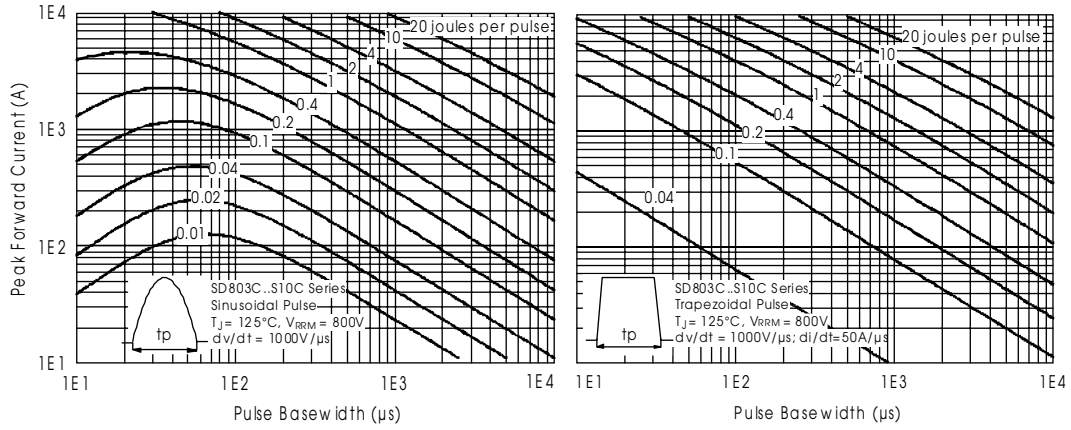

Fig. 17 - Maximum Total Energy Loss Per Pulse Characteristics

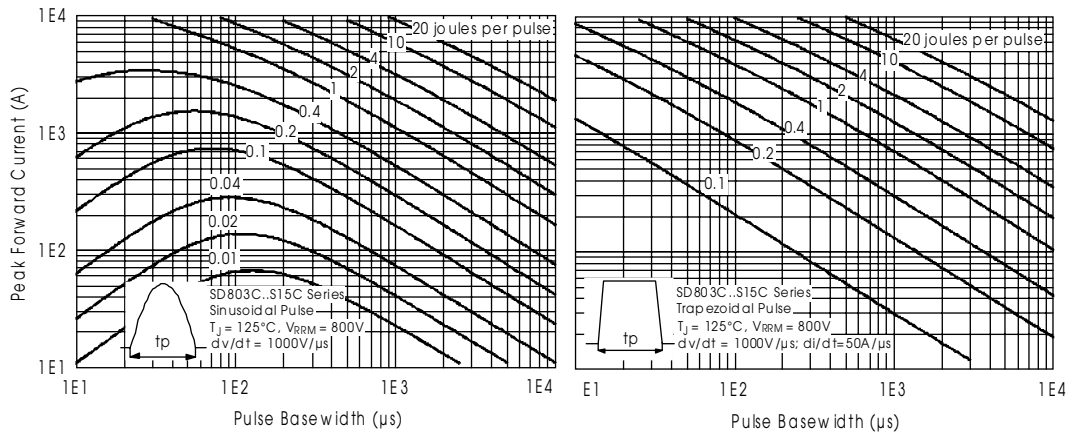

Fig. 18 - Maximum Total Energy Loss Per Pulse Characteristics