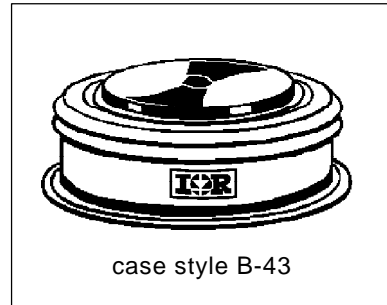

FAST RECOVERY DIODES
Hockey Puk Version
Features

- High power FAST recovery diode series
- 2.0 to 3.0 μ s recovery time
- High voltage ratings up to 2500V
- High current capability
- Optimized turn on and turn off characteristics
- Low forward recovery
- Fast and soft reverse recovery
- Press-puk encapsulation
- Hockey Puk version case style B-43
- Maximum junction temperature 150°C

810A
910A

Typical Applications

- Snubber diode for GTO
- High voltage free-wheeling diode
- Fast recovery rectifier applications

Major Ratings and Characteristics

Parameters	SD823C..C		Units
	S20	S30	
$I_{F(AV)}$	810	910	A
@ T_{hs}	55	55	°C
$I_{F(RMS)}$	1500	1690	A
I_{FSM} @ 50Hz	9300	9600	A
@ 60Hz	9730	10050	A
V_{RRM} range	1200 to 2500	1200 to 2500	V
t_{rr}	2.0	3.0	μ s
@ T_J	25	25	°C
T_J	- 40 to 150		°C

SD823C..C Series

ELECTRICAL SPECIFICATIONS

Voltage Ratings

Type number	Voltage Code	V_{RRM} , maximum repetitive peak reverse voltage V	V_{RSM} , maximum non-repetitive peak rev. voltage V	I_{RRM} max. @ $T_J = T_J$ max. mA
SD823C..C	12	1200	1300	50
	16	1600	1700	
	20	2000	2100	
	25	2500	2600	

Forward Conduction

Parameter	SD823C..C		Units	Conditions
	S20	S30		
$I_{F(AV)}$ Max. average forward current @ heatsink temperature	810 (425)	910 (470)	A	180° conduction, half sine wave
	55 (85)	55 (85)	°C	Double side (single side) cooled
$I_{F(RMS)}$ Max. RMS forward current	1500	1690	A	@ 25°C heatsink temperature double side cooled
I_{FSM} Max. peak, one-cycle forward, non-repetitive surge current	9300	9600	A	t = 10ms No voltage
	9730	10050		t = 8.3ms reapplied
	7820	8070		t = 10ms 100% V_{RRM}
	8190	8450		t = 8.3ms reapplied
I^2t Maximum I^2t for fusing	432	460	KA ² s	t = 10ms No voltage
	395	420		t = 8.3ms reapplied
	306	326		t = 10ms 100% V_{RRM}
	279	297		t = 8.3ms reapplied
$I^2\sqrt{t}$ Maximum $I^2\sqrt{t}$ for fusing	4320	4600	KA ² √s	t = 0.1 to 10ms, no voltage reapplied
$V_{F(TO)1}$ Low level value of threshold voltage	1.00	0.95	V	(16.7% × π × $I_{F(AV)}$) < I < π × $I_{F(AV)}$, $T_J = T_J$ max.
$V_{F(TO)2}$ High level value of threshold voltage	1.11	1.06		(I > π × $I_{F(AV)}$), $T_J = T_J$ max.
r_{f1} Low level value of forward slope resistance	0.80	0.60	mΩ	(16.7% × π × $I_{F(AV)}$) < I < π × $I_{F(AV)}$, $T_J = T_J$ max.
r_{f2} High level value of forward slope resistance	0.76	0.57		(I > π × $I_{F(AV)}$), $T_J = T_J$ max.
V_{FM} Max. forward voltage drop	2.20	1.85	V	$I_{pk} = 1500A$, $T_J = T_J$ max, $t_p = 10ms$ sinusoidal wave

Recovery Characteristics

Code	$T_J = 25^\circ\text{C}$ Typical t_{rr} @ 25% I_{RRM} (μs)	Test conditions			Max. values @ $T_J = 150^\circ\text{C}$		
		I_{pk} Square Pulse (A)	di/dt (A/μs)	V_r (V)	t_{rr} @ 25% I_{RRM} (μs)	Q_{rr} (μC)	I_{rr} (A)
S20	2.0	1000	50	-50	3.5	240	110
S30	3.0	1000	50	-50	5.0	380	130

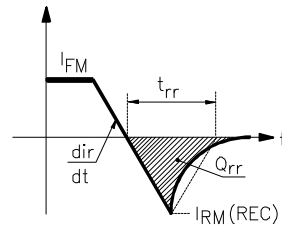

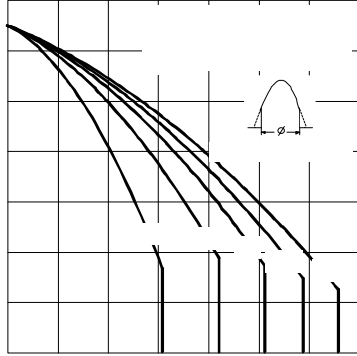

Fig. 3 - Current Ratings Characteristics

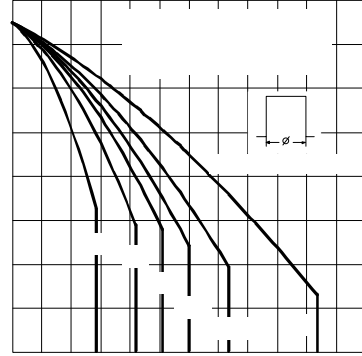

Fig. 4 - Current Ratings Characteristics

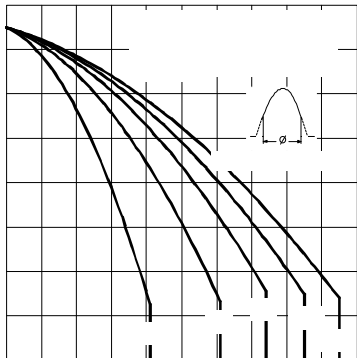

Fig. 5 - Current Ratings Characteristics

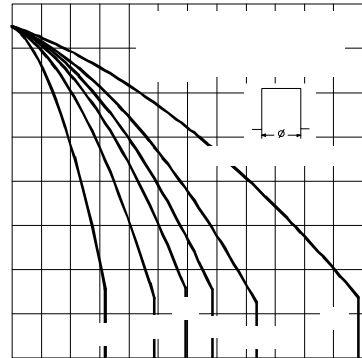

Fig. 6 - Current Ratings Characteristics

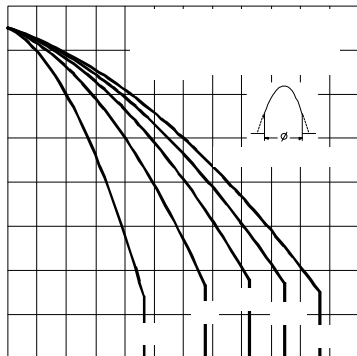

Fig. 7 - Current Ratings Characteristics

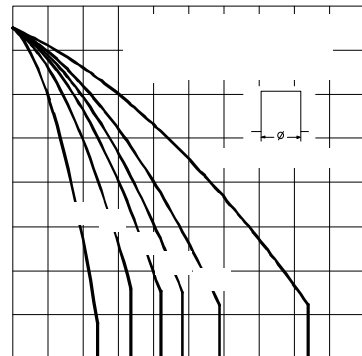

Fig. 8 - Current Ratings Characteristics

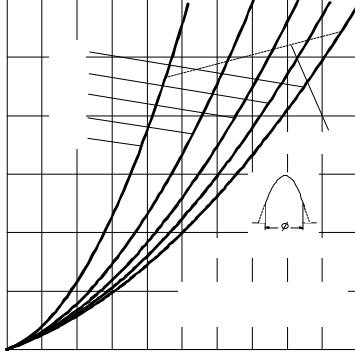

Fig. 9 - Forward Power Loss Characteristics

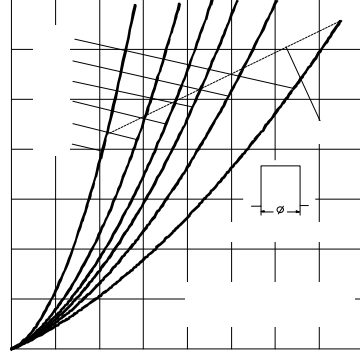

Fig. 10 - Forward Power Loss Characteristics

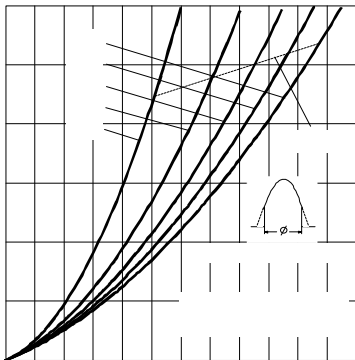

Fig. 11 - Forward Power Loss Characteristics

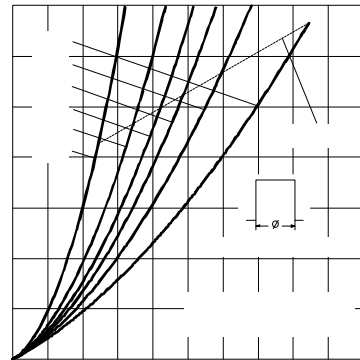

Fig. 12 - Forward Power Loss Characteristics

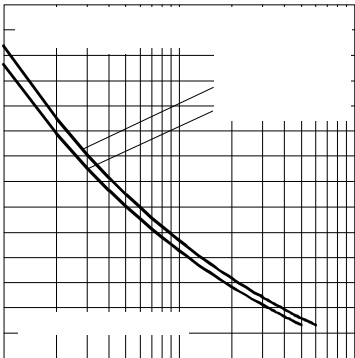

Fig. 13 - Maximum Non-repetitive Surge Current

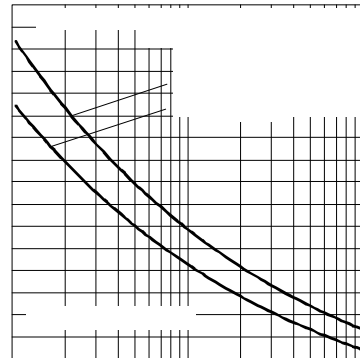

Fig. 14 - Maximum Non-repetitive Surge Current

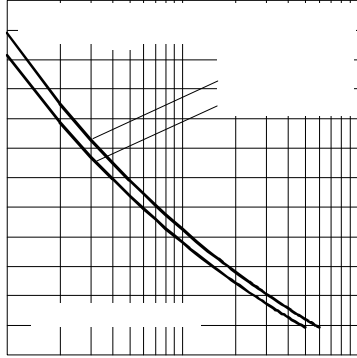

Fig. 15 - Maximum Non-repetitive Surge Current

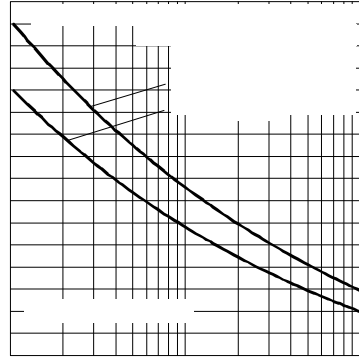

Fig. 16 - Maximum Non-repetitive Surge Current

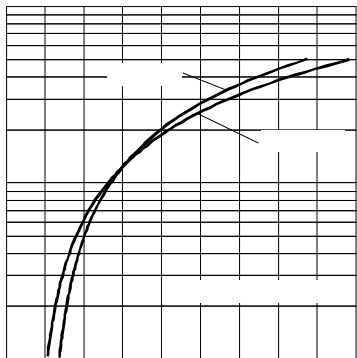

Fig. 17 - Forward Voltage Drop Characteristics

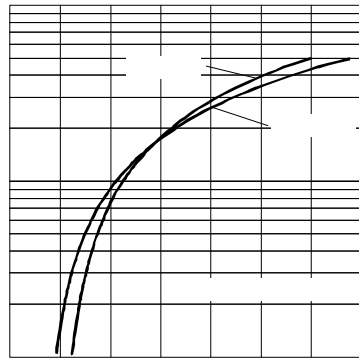

Fig. 18 - Forward Voltage Drop Characteristics

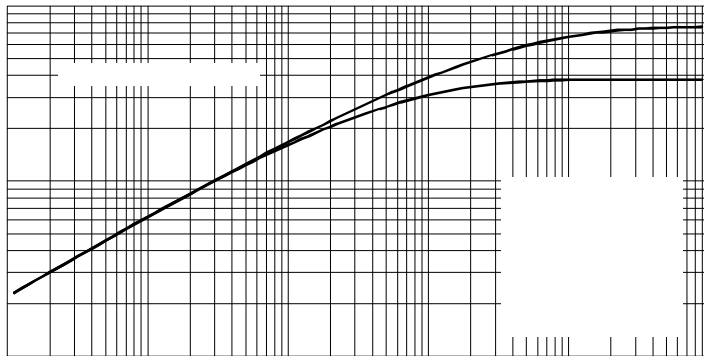

Fig. 19 - Thermal Impedance $Z_{th-j-hs}$ Characteristic

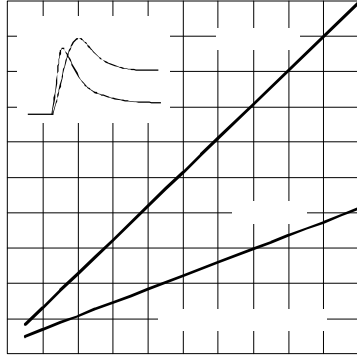

Fig. 20 - Typical Forward Recovery Characteristics

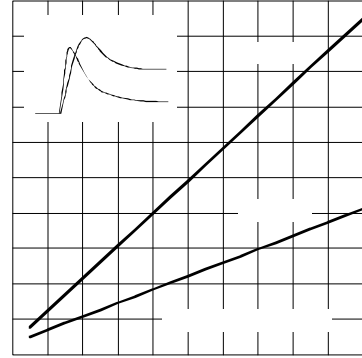

Fig. 21 - Typical Forward Recovery Characteristics

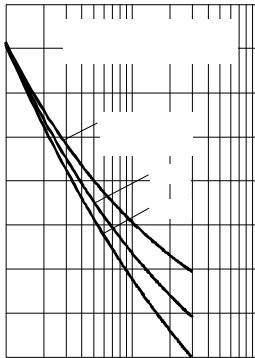

Fig. 22 - Recovery Time Characteristics

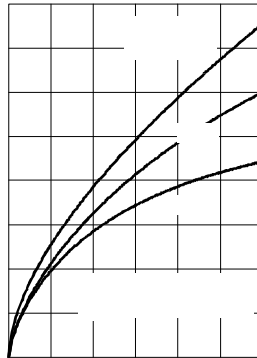

Fig. 23 - Recovery Charge Characteristics

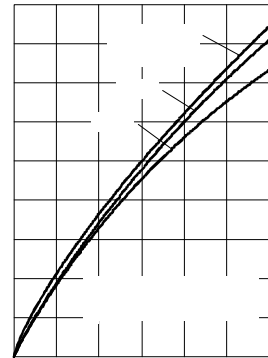

Fig. 24 - Recovery Current Characteristics

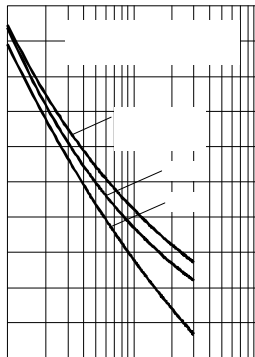

Fig. 25 - Recovery Time Characteristics

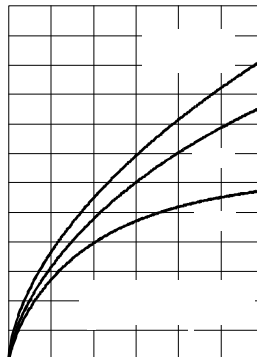

Fig. 26 - Recovery Charge Characteristics



Fig. 27 - Recovery Current Characteristics

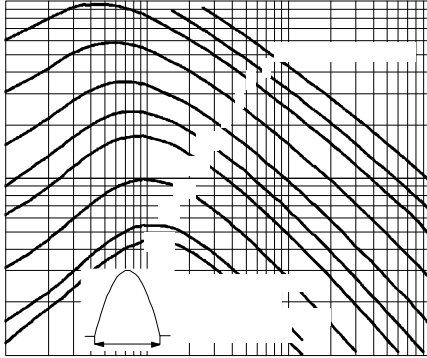

Fig. 28 - Maximum Total Energy Loss Per Pulse Characteristics

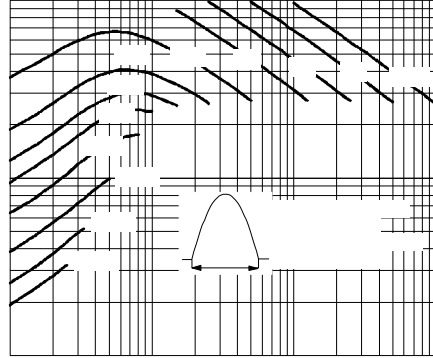

Fig. 29 - Frequency Characteristics

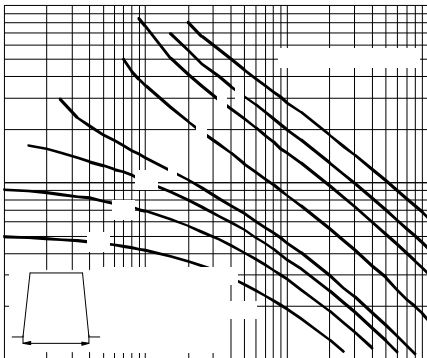

Fig. 30 - Maximum Total Energy Loss Per Pulse Characteristics

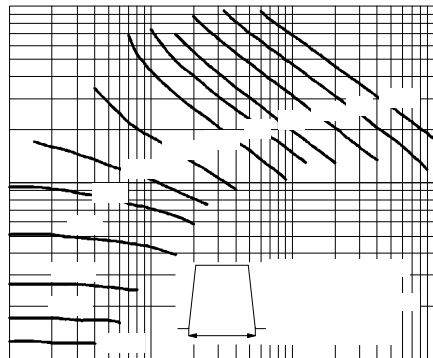

Fig. 31 - Frequency Characteristics

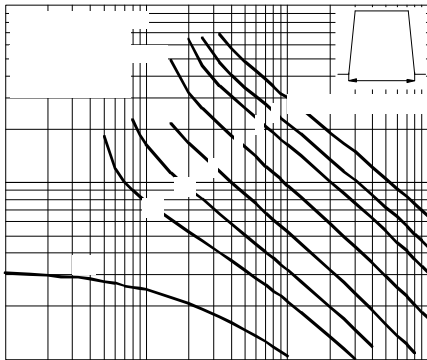

Fig. 32 - Maximum Total Energy Loss Per Pulse Characteristics

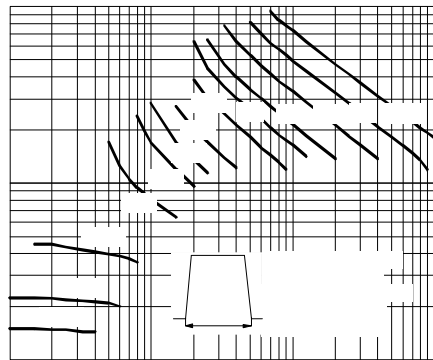

Fig. 33 - Frequency Characteristics

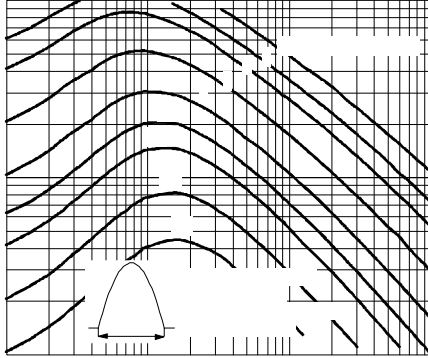

Fig. 34 - Maximum Total Energy Loss Per Pulse Characteristics

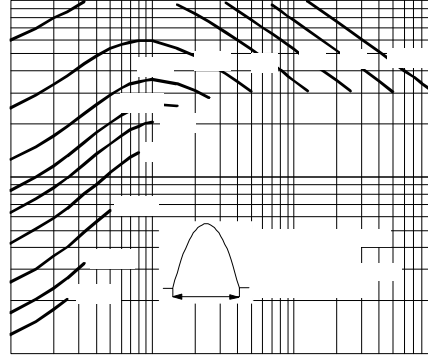

Fig. 35 - Frequency Characteristics

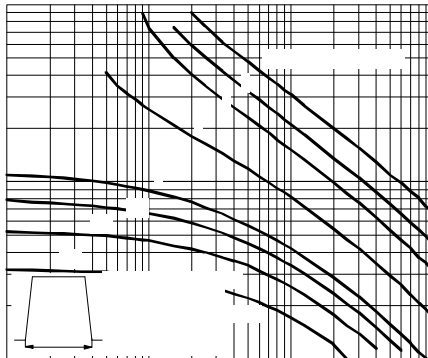

Fig. 36 - Maximum Total Energy Loss Per Pulse Characteristics

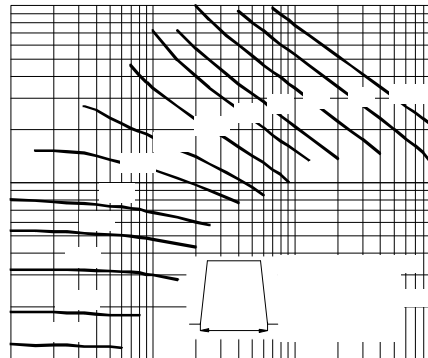

Fig. 37 - Frequency Characteristics

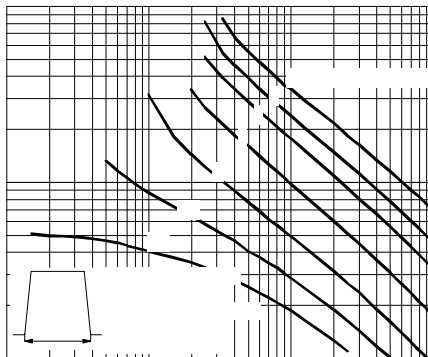

Fig. 38 - Maximum Total Energy Loss Per Pulse Characteristics

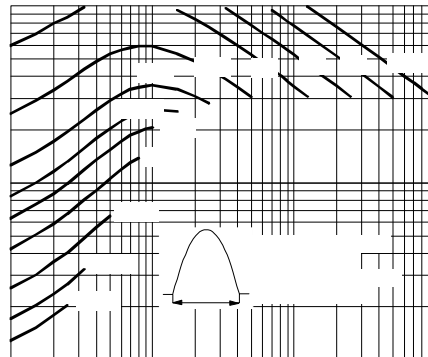

Fig. 39 - Frequency Characteristics

Thermal and Mechanical Specifications

Parameter	SD823C..C		Units	Conditions
	S20	S30		
T_J Max. junction operating temperature range	-40 to 150		°C	
T_{stg} Max. storage temperature range	-40 to 150			
R_{thJ-hs} Max. thermal resistance, case junction	0.076 to heatsink		K/W 0.038	DCoperation single side cooled DCoperation double side cooled
F Mounting force, $\pm 10\%$	9800 (1000)		N (Kg)	
wt Approximate weight	83		g	
Case style	B-43			See Outline Table

 ΔR_{thJ-hs} Conduction

(The following table shows the increment of thermal resistance R_{thJ-hs} when devices operate at different conduction angles than DC)

Conduction angle	Sinusoidal conduction		Rectangular conduction		Units	Conditions
	Single Side	Double Side	Single Side	Double Side		
180°	0.007	0.007	0.005	0.005	K/W	$T_J = T_J \text{ max.}$
120°	0.008	0.008	0.008	0.008		
90°	0.010	0.010	0.011	0.011		
60°	0.015	0.015	0.016	0.016		
30°	0.026	0.026	0.026	0.026		

Ordering Information Table

Device Code	
SD 82 3 C 25 S20 C	
① ② ③ ④ ⑤ ⑥ ⑦	
1	- Diode
2	- Essential part number
3	- 3 = Fast recovery
4	- C = Ceramic Puk
5	- Voltage code: Code x 100 = V_{RRM} (See Voltage Ratings table)
6	- t_{rr} code
7	- C = Puk Case B-43

SD823C..C Series

Outline Table

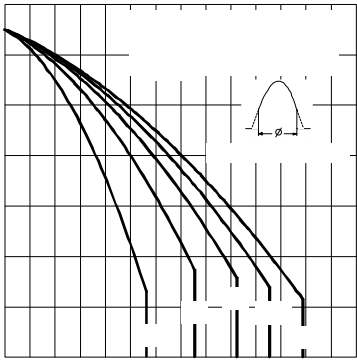
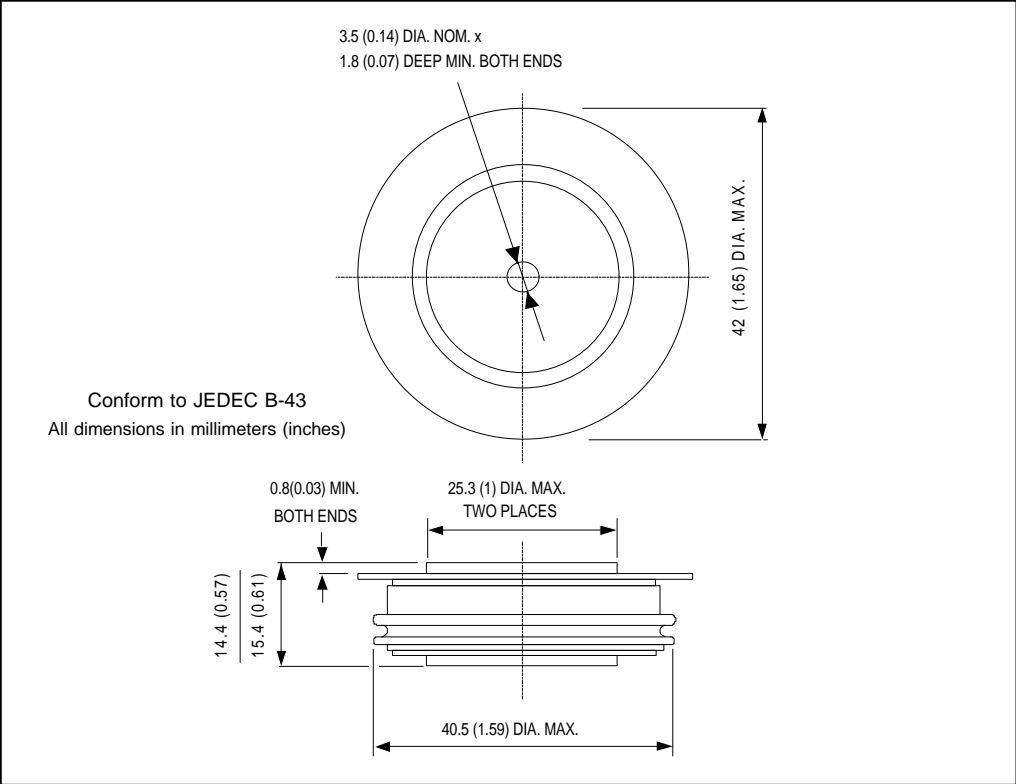

Fig. 1 - Current Ratings Characteristics

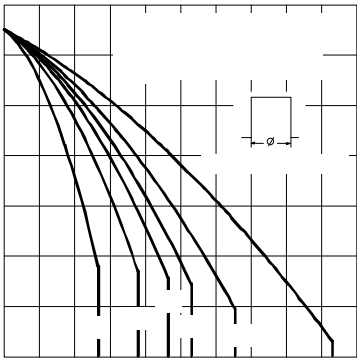

Fig. 2 - Current Ratings Characteristics