

### Features

- Diffused Junction
- Low Forward Voltage Drop
- High Current Capability
- High Reliability
- High Surge Current Capability

### Mechanical Data

- Case: Molded Plastic
- Terminals: Plated Leads Solderable per MIL-STD-202, Method 208
- Polarity: Cathode Band
- Weight: 0.34 grams (approx.)
- Mounting Position: Any
- Marking: Type Number
- **Lead Free: For RoHS / Lead Free Version**

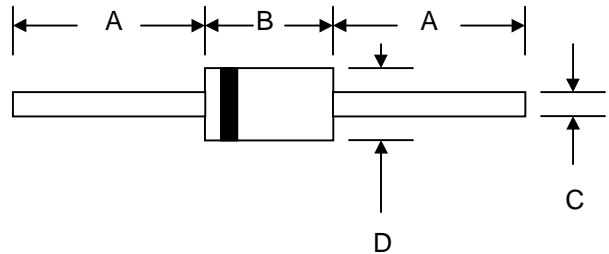

DO-41		
Dim	Min	Max
A	24.5	—
B	4.06	5.21
C	0.60	0.80
D	2.00	3.00
All Dimensions in mm		

### Maximum Ratings and Electrical Characteristics @ $T_A=25^\circ\text{C}$ unless otherwise specified

Single Phase, half wave, 60Hz, resistive or inductive load.  
For capacitive load, derate current by 20%.

Characteristic	Symbol	SF11	SF12	SF13	SF14	SF15	SF16	SF17	SF18	Unit	
Peak Repetitive Reverse Voltage	$V_{RRM}$									V	
Working Peak Reverse Voltage	$V_{RWM}$	50	100	150	200	300	400	500	600		
DC Blocking Voltage	$V_R$										
RMS Reverse Voltage	$V_{R(RMS)}$	35	70	105	140	210	280	350	420	V	
Average Rectified Output Current (Note 1) @ $T_A = 55^\circ\text{C}$	$I_O$	1.0								A	
Non-Repetitive Peak Forward Surge Current 8.3ms Single half sine-wave superimposed on rated load (JEDEC Method)	$I_{FSM}$	30								A	
Forward Voltage @ $I_F = 1.0\text{A}$	$V_{FM}$	0.95			1.30		1.70			V	
Peak Reverse Current @ $T_A = 25^\circ\text{C}$ At Rated DC Blocking Voltage @ $T_A = 100^\circ\text{C}$	$I_{RM}$	5.0				100					$\mu\text{A}$
Reverse Recovery Time (Note 2)	$t_{rr}$	35								nS	
Typical Junction Capacitance (Note 3)	$C_j$	20				10					pF
Operating Temperature Range	$T_j$	-65 to +150								$^\circ\text{C}$	
Storage Temperature Range	$T_{STG}$	-65 to +150								$^\circ\text{C}$	

**\*Glass passivated forms are available upon request**

- Note: 1. Leads maintained at ambient temperature at a distance of 9.5mm from the case  
2. Measured with  $I_F = 0.5\text{A}$ ,  $I_R = 1.0\text{A}$ ,  $IRR = 0.25\text{A}$ . See figure 5.  
3. Measured at 1.0 MHz and applied reverse voltage of 4.0V D.C.

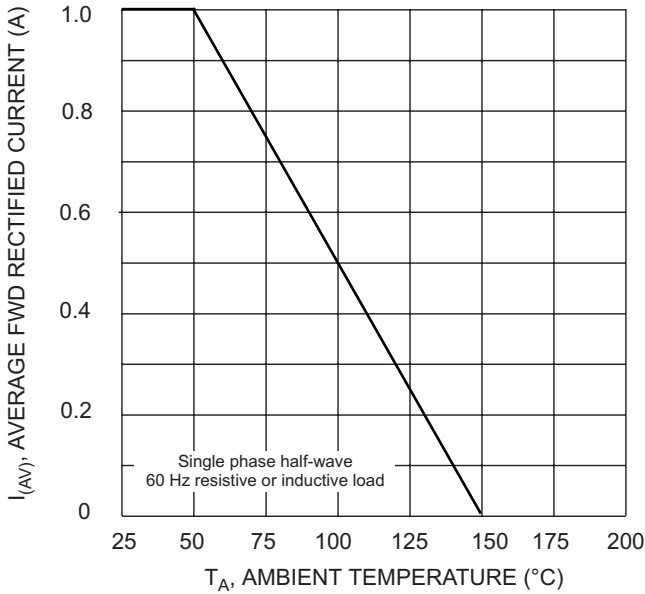

Fig. 1 Forward Derating Curve

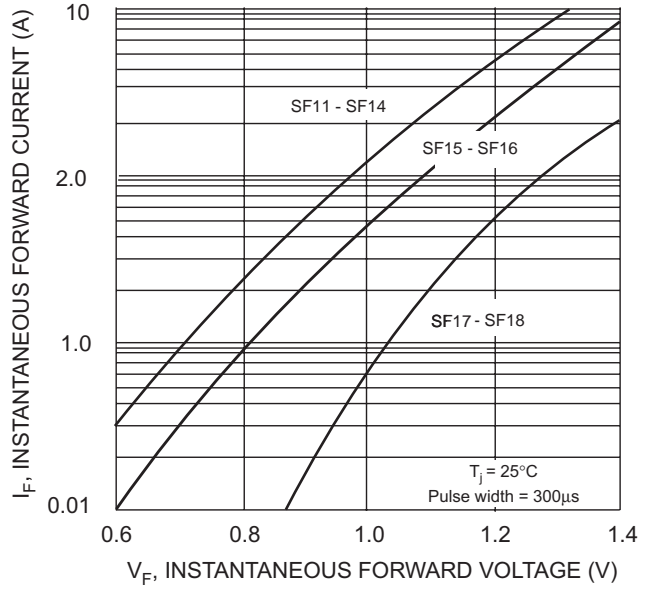

Fig. 2 Typical Forward Characteristics

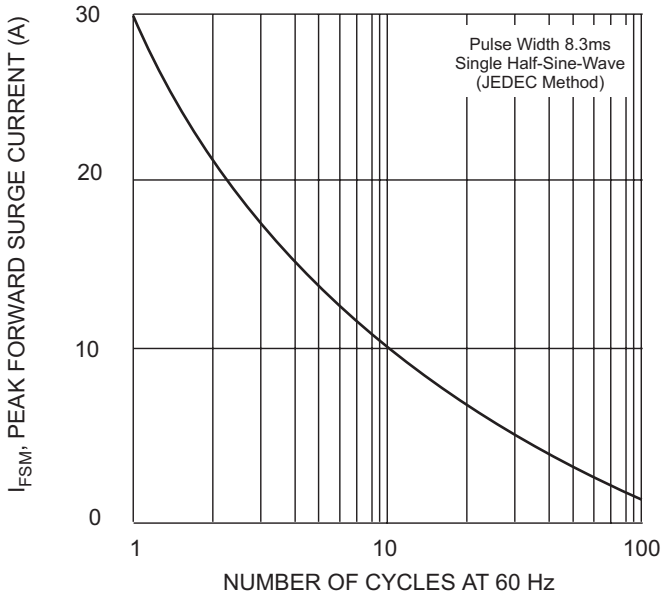

Fig. 3 Peak Forward Surge Current

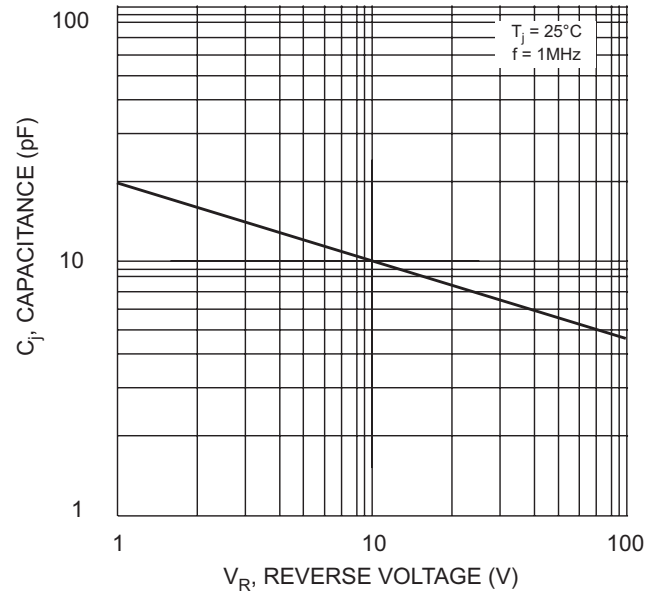
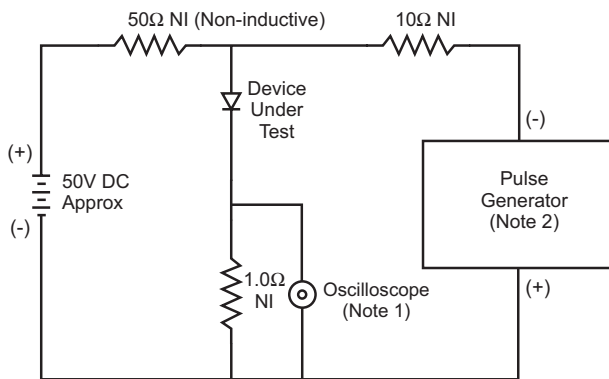

Fig. 4 Typical Junction Capacitance



Notes:

1. Rise Time = 7.0ns max. Input Impedance = 1.0MΩ, 22pF.
2. Rise Time = 10ns max. Input Impedance = 50Ω.

Fig. 5 Reverse Recovery Time Characteristic and Test Circuit

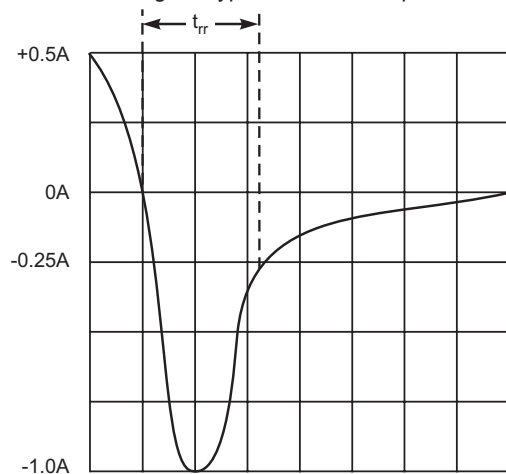

Set time base for 5/10ns/cm