

SF161 THRU SF168

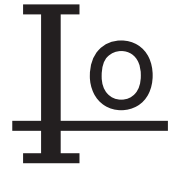

16.0 AMP SUPER FAST RECTIFIERS



FEATURES

- * Low forward voltage drop
- * High current capability
- * High reliability
- * High surge current capability
- * Good for switching mode application

MECHANICAL DATA

- * Case: Molded plastic
- * Epoxy: UL 94V-0 rate flame retardant
- * Lead: Lead solderable per MIL-STD-202, method 208 guaranteed
- * Polarity: As Marked
- * Mounting position: Any
- * Weight: 2.24 grams

VOLTAGE RANGE

50 to 600 Volts

CURRENT

16.0 Amperes

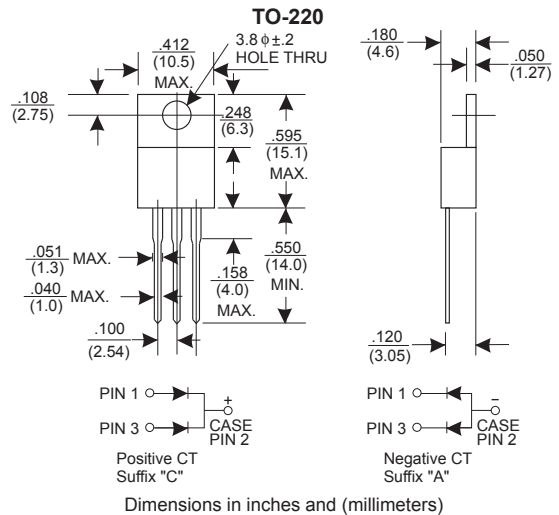

MAXIMUM RATINGS AND ELECTRICAL CHARACTERISTICS

Rating 25°C ambient temperature unless otherwise specified.
Single phase half wave, 60Hz, resistive or inductive load.
For capacitive load, derate current by 20%.

| TYPE NUMBER | SF161 | SF162 | SF163 | SF164 | SF165 | SF166 | SF168 | UNITS |
|---|------------|-------|-------|-------|-------|-------|-------|-------|
| Maximum Recurrent Peak Reverse Voltage | 50 | 100 | 150 | 200 | 300 | 400 | 600 | V |
| Maximum RMS Voltage | 35 | 70 | 105 | 140 | 210 | 280 | 420 | V |
| Maximum DC Blocking Voltage | 50 | 100 | 150 | 200 | 300 | 400 | 600 | V |
| Maximum Average Forward Rectified Current .375"(9.5mm) Lead Length at Tc=125°C | 16.0 | | | | | | | A |
| Peak Forward Surge Current, 8.3 ms single half sine-wave superimposed on rated load (JEDEC method) | 125 | | | | | | | A |
| Maximum Instantaneous Forward Voltage at 8.0A | 0.95 | | | | 1.30 | 1.70 | | V |
| Maximum DC Reverse Current at Rated DC Blocking Voltage | Tc=25°C | | | 10 | | | μA | |
| | Tc=100°C | | | 500 | | | μA | |
| Maximum Reverse Recovery Time (Note 1) | 35 | | | 50 | | | nS | |
| Typical Junction Capacitance (Note 2) | 50 | | | | | | | pF |
| Operating and Storage Temperature Range Tj, Tstg | -65 — +150 | | | | | | | °C |

NOTES:

- Reverse Recovery Time test condition: IF=0.5A, IR=1.0A, IRR=0.25A
- Measured at 1MHz and applied reverse voltage of 4.0V D.C.

RATING AND CHARACTERISTIC CURVES (SF161 THRU SF168)

FIG.1- TEST CIRCUIT DIAGRAM AND REVERSE RECOVERY TIME CHARACTERISTIC

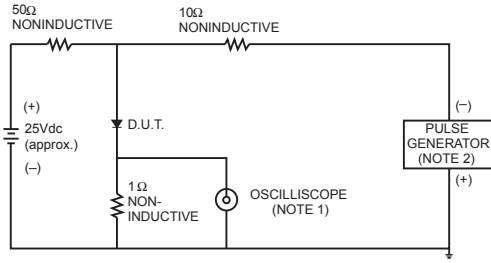

NOTES: 1. Rise Time= 7ns max., Input Impedance= 1 megohm, 22pF.
2. Rise Time= 10ns max., Source Impedance= 50 ohms.

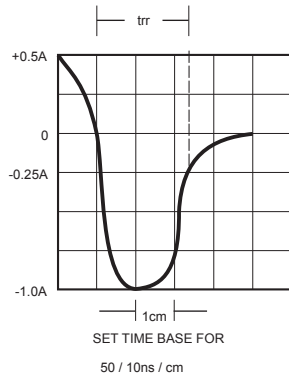

FIG.2-TYPICAL FORWARD CURRENT DERATING CURVE

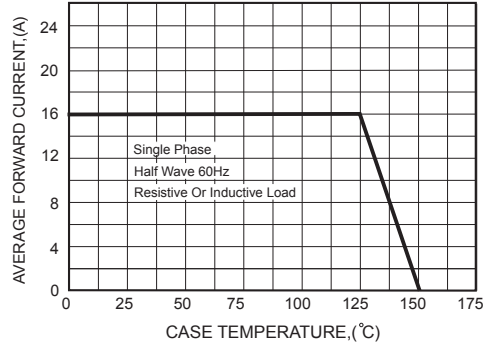

FIG.3-TYPICAL FORWARD CHARACTERISTICS

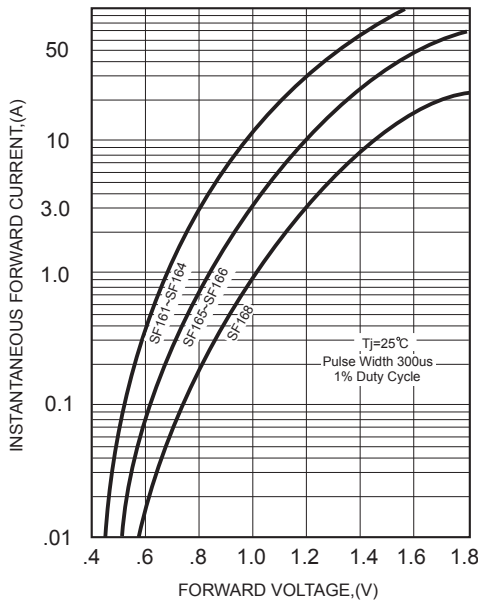

FIG.4-TYPICAL REVERSE CHARACTERISTICS

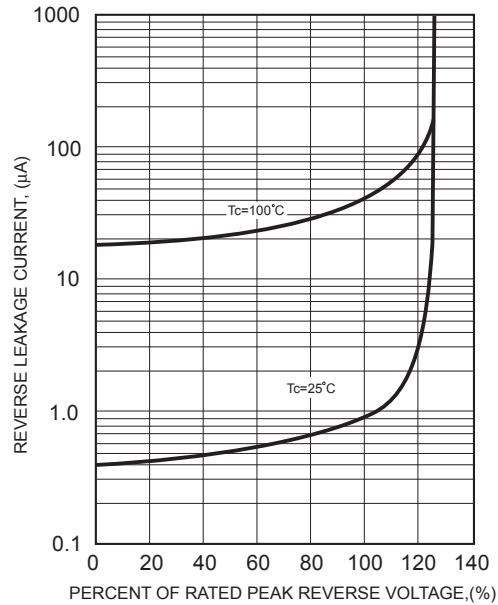

FIG.5-MAXIMUM NON-REPETITIVE FORWARD SURGE CURRENT

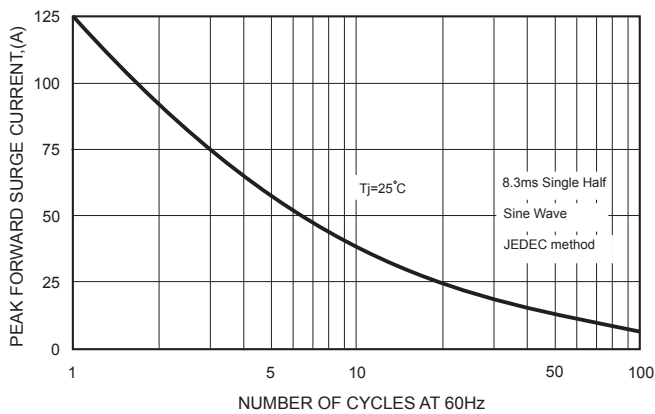

FIG.6-TYPICAL JUNCTION CAPACITANCE

