



Features

- Diffused Junction
- Low Forward Voltage Drop
- High Current Capability
- High Reliability
- High Surge Current Capability

Mechanical Data

- Case: Molded Plastic
- Terminals: Plated Leads Solderable per MIL-STD-202, Method 208
- Polarity: Cathode Band
- Weight: 0.40 grams (approx.)
- Mounting Position: Any
- Marking: Type Number

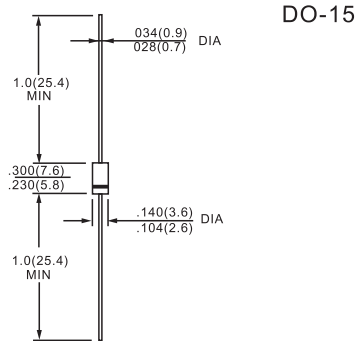

Dimensions in inches and (millimeters)

MAXIMUM RATINGS AND ELECTRICAL CHARACTERISTICS

Rating 25°C ambient temperature unless otherwise specified.
Single phase half wave, 60Hz, resistive or inductive load.
For capacitive load, derate current by 20%.

TYPE NUMBER	SF21	SF22	SF23	SF24	SF25	SF26	SF27	SF28	UNITS
Maximum Recurrent Peak Reverse Voltage									
Maximum RMS Voltage									
Maximum DC Blocking Voltage									
Maximum Average Forward Rectified Current .375"(9.5mm) Lead Length at Ta=55°C	2.0								A
Peak Forward Surge Current, 8.3 ms single half sine-wave superimposed on rated load (JEDEC method)	60								A
Maximum Instantaneous Forward Voltage at 2.0A	0.95		1.25			1.50			V
Maximum DC Reverse Current Ta=25°C	5.0								A
at Rated DC Blocking Voltage Ta=100°C	50								A
Maximum Reverse Recovery Time (Note 1)	35								nS
Typical Junction Capacitance (Note 2)	60								pF
Operating and Storage Temperature Range Tj, Tstg	-65 — +150								°C

NOTES:

1. Reverse Recovery Time test condition: IF=0.5A, IR=1.0A, IRR=0.25A
2. Measured at 1MHz and applied reverse voltage of 4.0V D.C.

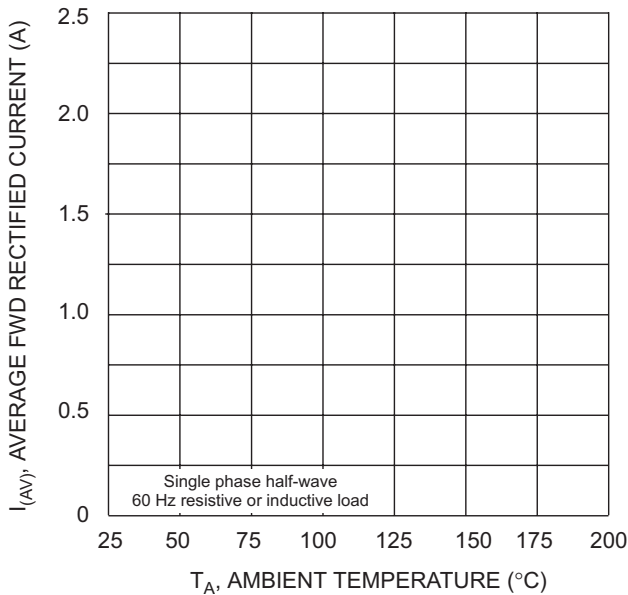

Fig. 1 Forward Current Derating Curve

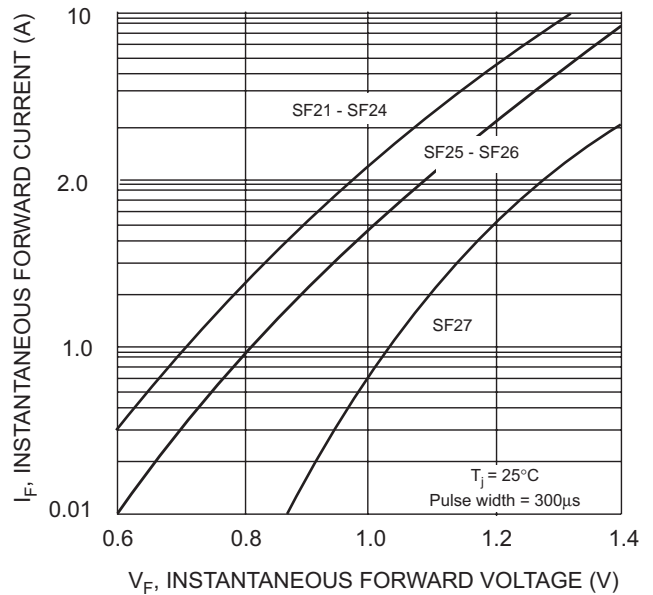

Fig. 2 Typical Forward Characteristics

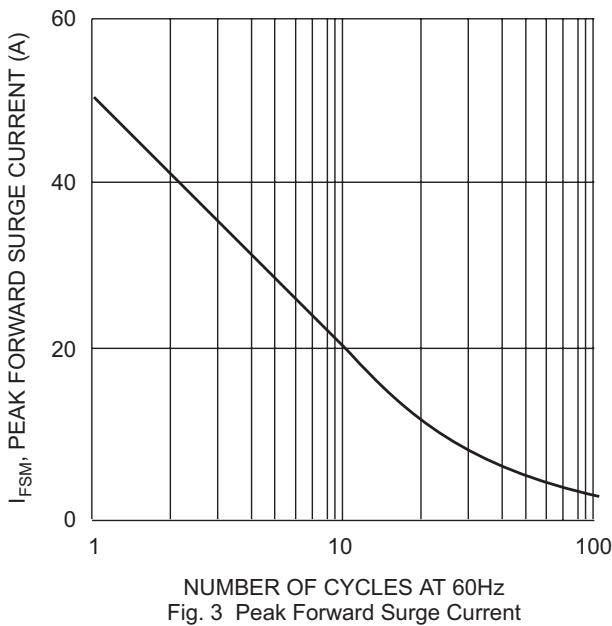

Fig. 3 Peak Forward Surge Current

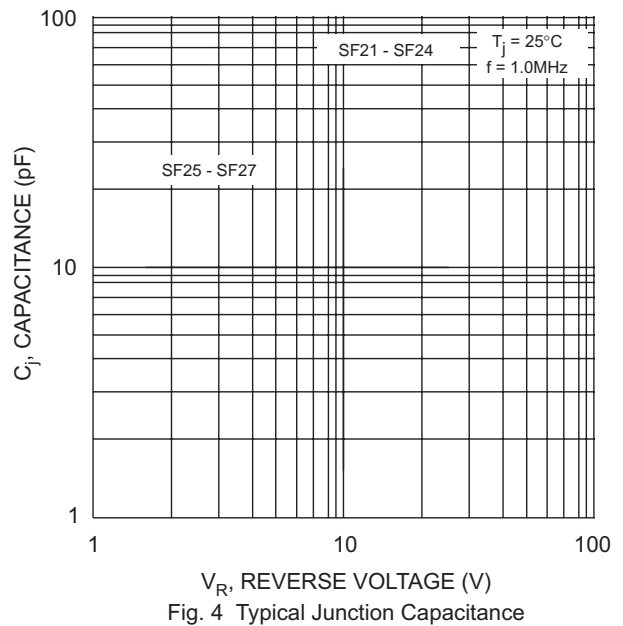

Fig. 4 Typical Junction Capacitance

FIG.5- TEST CIRCUIT DIAGRAM AND REVERSE RECOVERY TIME CHARACTERISTIC

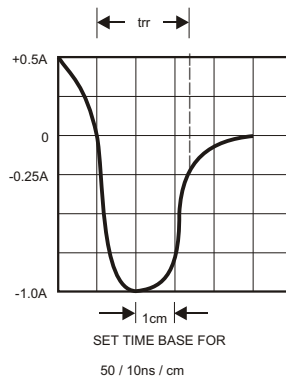
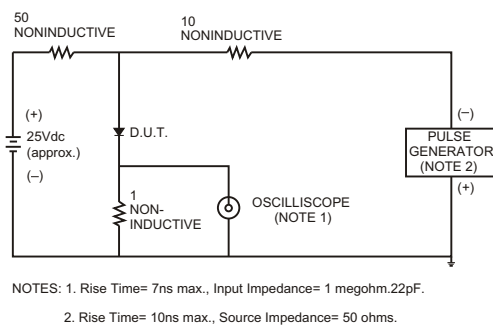

FIG.6-TYPICAL FORWARD CURRENT DERATING CURVE

