

Rote Punktlichtquelle
Red Pointsource Emitter
Lead (Pb) Free Product - RoHS Compliant

SFH 4276

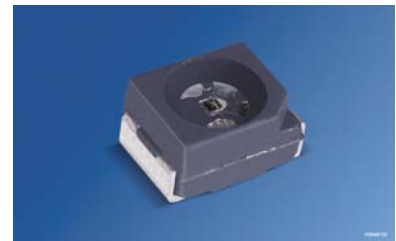

Nicht für Neuentwicklungen / Not for new designs

Wesentliche Merkmale

- Schwarz eingefärbtes TOPLED-Gehäuse
- Typische Emissionswellenlänge 655nm
- Runde Emissionsfläche mit Durchmesser 170µm
- Keine Seitenstrahlung
- IR Reflow und TTW Löten geeignet
- Feuchte-Empfindlichkeitsstufe 2 nach JEDEC Standard J-STD-020C

Features

- Black coloured TOPLED-package
- Typical Peakwavelength 655nm
- Emission area with diameter 170µm
- No side emission
- Suited for IR Reflow and TTW-soldering
- Moisture sensitivity level 2 according to JEDEC Standard J-STD-020C

Anwendungen

- Miniaturlichtschranken und Lichtschranken über große Entfernungen
- Industrieelektronik
- „Messen/Steuern/Regeln“
- Automobiltechnik
- Sensorik
- Alarm- und Sicherungssysteme

Applications

- Miniature and long distance photointerrupters
- Industrial electronics
- For drive and control circuits
- Automotive technology
- Sensor technology
- Alarm and safety equipment

Typ Type	Bestellnummer Ordering Code	Strahlstärkegruppierung ¹⁾ ($I_F = 50 \text{ mA}$, $t_p = 20 \text{ ms}$) Radiant intensity grouping ¹⁾ I_e (mW/sr)
SFH 4276	Q65110A2524	1.2 ($0.63 \leq \dots \leq 2$)

¹⁾ gemessen bei einem Raumwinkel $\Omega = 0.01 \text{ sr}$ / measured at a solid angle of $\Omega = 0.01 \text{ sr}$

Grenzwerte ($T_A = 25\text{ °C}$)

Maximum Ratings

Bezeichnung Parameter	Symbol Symbol	Wert Value	Einheit Unit
Betriebs- und Lagertemperatur Operating and storage temperature range	$T_{op}; T_{stg}$	- 40 ... + 100	°C
Sperrspannung Reverse voltage	V_R	5	V
Durchlaßstrom Forward current	I_F	50	mA
Pulsstrom, $\tau = 10\ \mu\text{s}$, $D = 0.1$ puls current	I_{Fp}	500	mA
Verlustleistung Power dissipation	P_{tot}	125	mW
Wärmewiderstand Sperrschicht - Umgebung bei Montage auf FR4 Platine, Padgröße je $16\ \text{mm}^2$ Thermal resistance junction - ambient mounted on PC-board (FR4), pads size $16\ \text{mm}^2$ each	R_{thJA}	300	K/W
Elektrostatische Entladung Electrostatic discharge	ESD	2	kV

Kennwerte ($T_A = 25\text{ °C}$)

Characteristics

Bezeichnung Parameter	Symbol Symbol	Wert Value	Einheit Unit
Wellenlänge der Strahlung Wavelength at peak emission $I_F = 20\text{ mA}$, $t_p = 20\text{ ms}$	λ_{peak}	655	nm
Spektrale Bandbreite bei 50% von I_{max} Spectral bandwidth at 50% of I_{max} $I_F = 20\text{ mA}$	$\Delta\lambda$	16	nm
Abstrahlwinkel Half angle	φ	± 60	Grad deg.
Aktive Chipfläche Active chip area	A	0.019	mm ²
Durchmesser der aktiven Chipfläche Diameter of the active chip area	D	170	μm
Durchlaßspannung, Forward voltage $I_F = 50\text{ mA}$, $t_p = 20\text{ ms}$	V_F	2.1 (≤ 2.6)	V
Sperrstrom, Reverse current $V_R = 5\text{ V}$	I_R	0.01 (≤ 10)	μA
Gesamtstrahlungsfluß, Total radiant flux $I_F = 50\text{ mA}$, $t_p = 20\text{ ms}$	Φ_e	3.5	mW
Temperaturkoeffizient von I_e bzw. Φ_e Temperature coefficient of I_e or Φ_e $I_F = 50\text{ mA}$	TC_I	-0.5	%/K
Temperaturkoeffizient von V_F Temperature coefficient of V_F $I_F = 50\text{ mA}$	TC_V	-2.5	mV/K
Temperaturkoeffizient von λ Temperature coefficient of λ $I_F = 50\text{ mA}$	TC_λ	0.14	nm/K

Strahlstärke I_e in Achsrichtunggemessen bei einem Raumwinkel $\Omega = 0.01$ sr**Radiant Intensity I_e in Axial Direction**at a solid angle of $\Omega = 0.01$ sr

Bezeichnung Parameter	Symbol	Werte Values		Einheit Unit
		-K	-L	
Strahlstärke	I_{emin}	0.63	1	mW/sr
Radiant intensity	I_{emax}	1.25	2	
$I_F = 50$ mA, $t_p = 20$ ms				

Relative Spectral Emission

$I_{rel} = f(\lambda)$

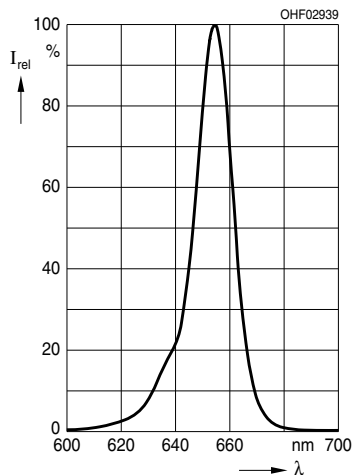

Radiant Intensity

$I_e / I_{e(50 mA)} = f(I_F)$

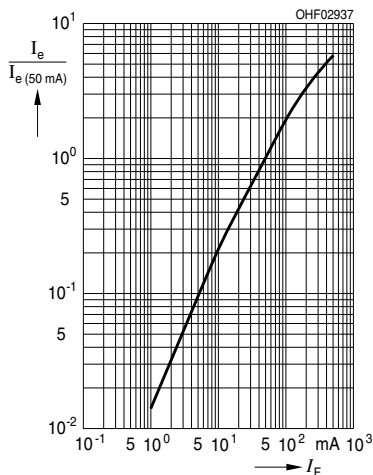

Max. Permissible Forward Current

$I_F = f(T_A)$

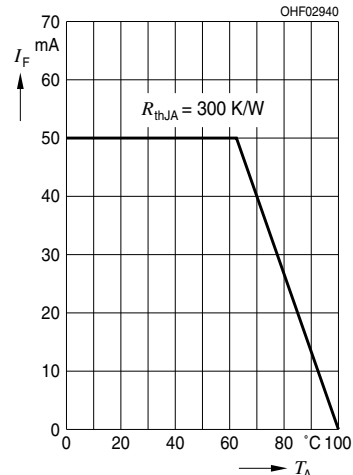

Forward Current

$I_F = f(V_F)$ single pulse, $t_p = 20 \mu s$

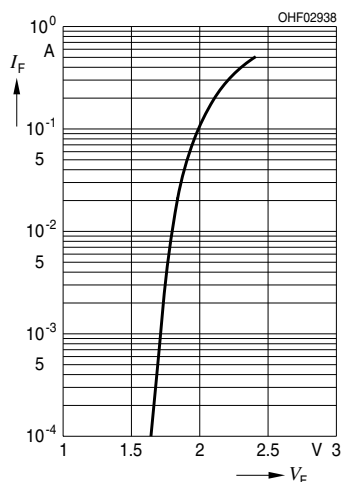

Radiation Characteristics $I_{rel} = f(\phi)$ (Farfield)

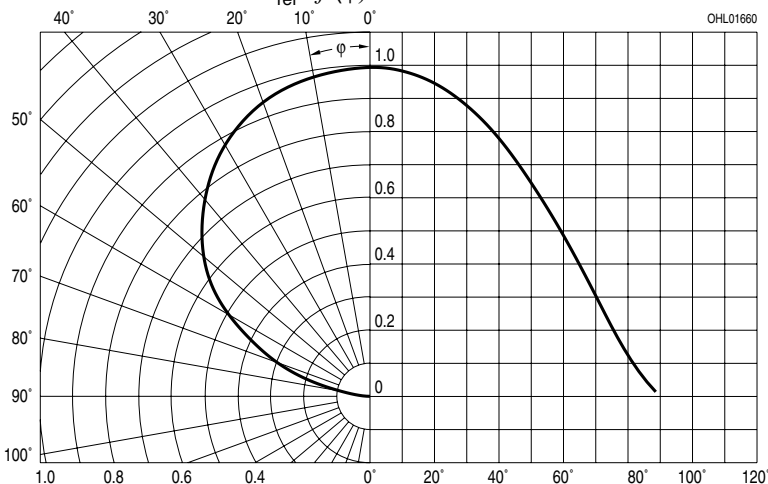

Permissible Puls Handling Capability

$I_F = f(\tau)$, $T_A = 25^\circ C$, duty cycle $D = \text{parameter}$

duty cycle $D = \text{parameter}$

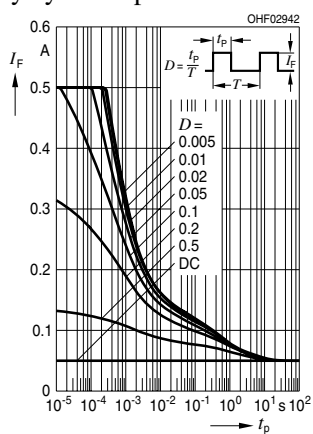

Radiation Pattern $E_{e rel} = f(d)$ (5mm)

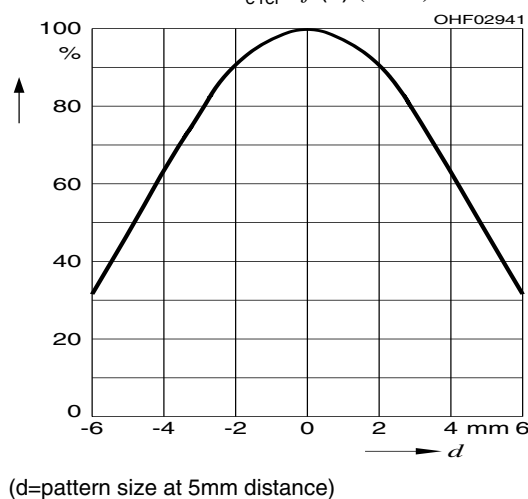

Maßzeichnung Package Outlines

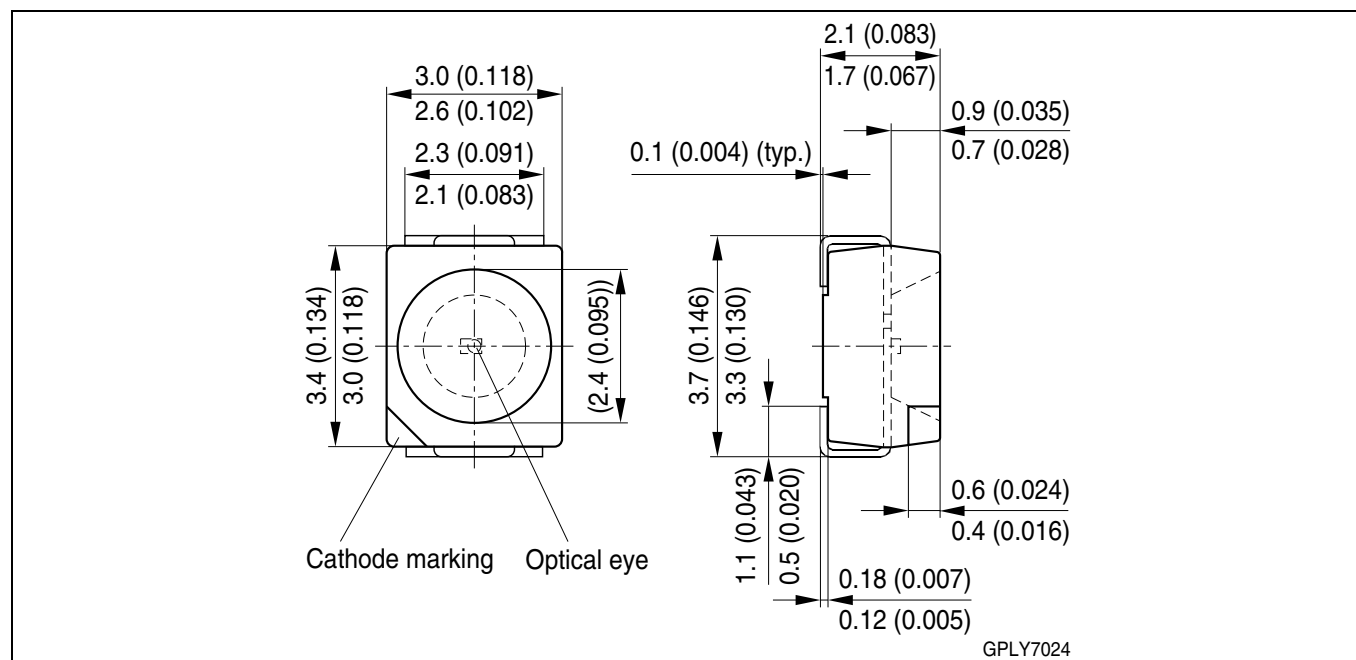

Maße in mm (inch) / Dimensions in mm (inch).

Gehäusefarbe: schwarz, Verguss klar

Brechungsindex Verguss: 1.53

Package Colour: black, resin colourless clear

Refractive index resin: 1.53

Empfohlenes Lötpaddesign
Recommended Solder Pad

Reflow Löten
Reflow Soldering

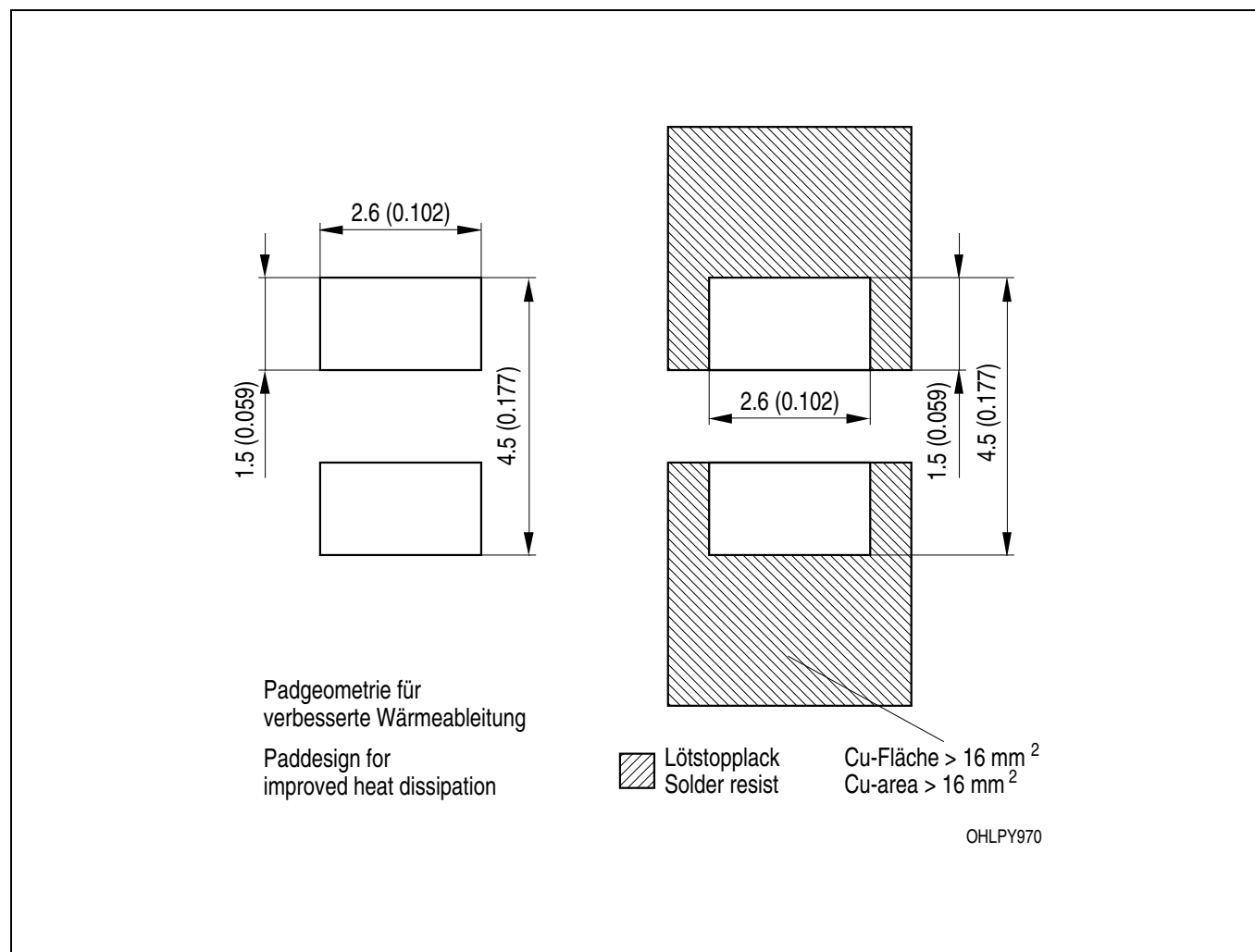

Maße in mm (inch) / Dimensions in mm (inch)
Gehäuse für Wellenlöten (TTW) geeignet / Package suitable for TTW-soldering

Lötbedingungen
Soldering Conditions
Reflow Lötprofil für bleifreies Löten
Reflow Soldering Profile for lead free soldering

Vorbehandlung nach JEDEC Level 2
 Preconditioning acc. to JEDEC Level 2
 (nach J-STD-020C)
 (acc. to J-STD-020C)

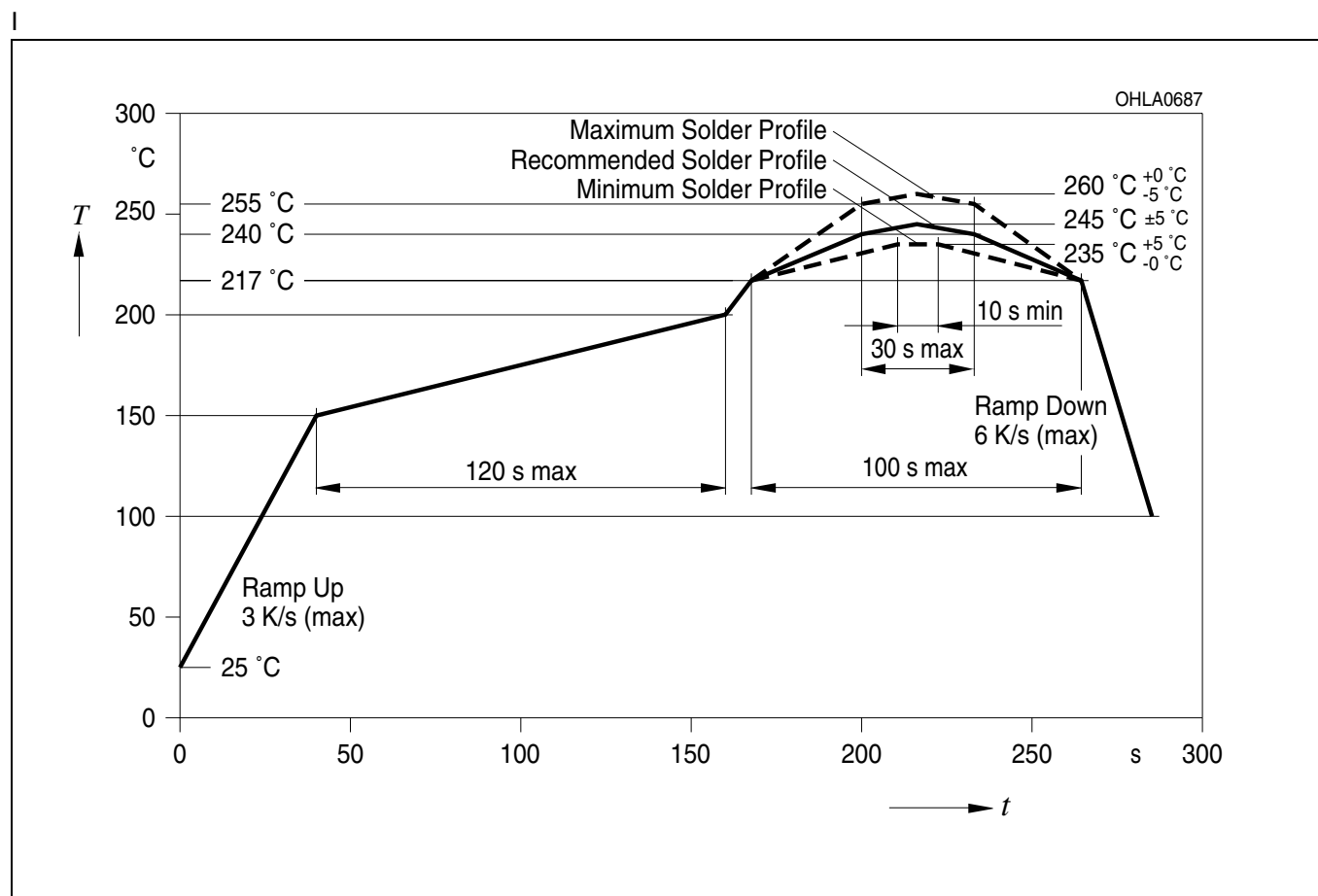

Lötbedingungen
Soldering Conditions
Wellenlöten (TTW)
TTW Soldering

Vorbehandlung nach JEDEC Level 2
 Preconditioning acc. to JEDEC Level 2
 (nach CECC 00802)
 (acc. to CECC 00802)

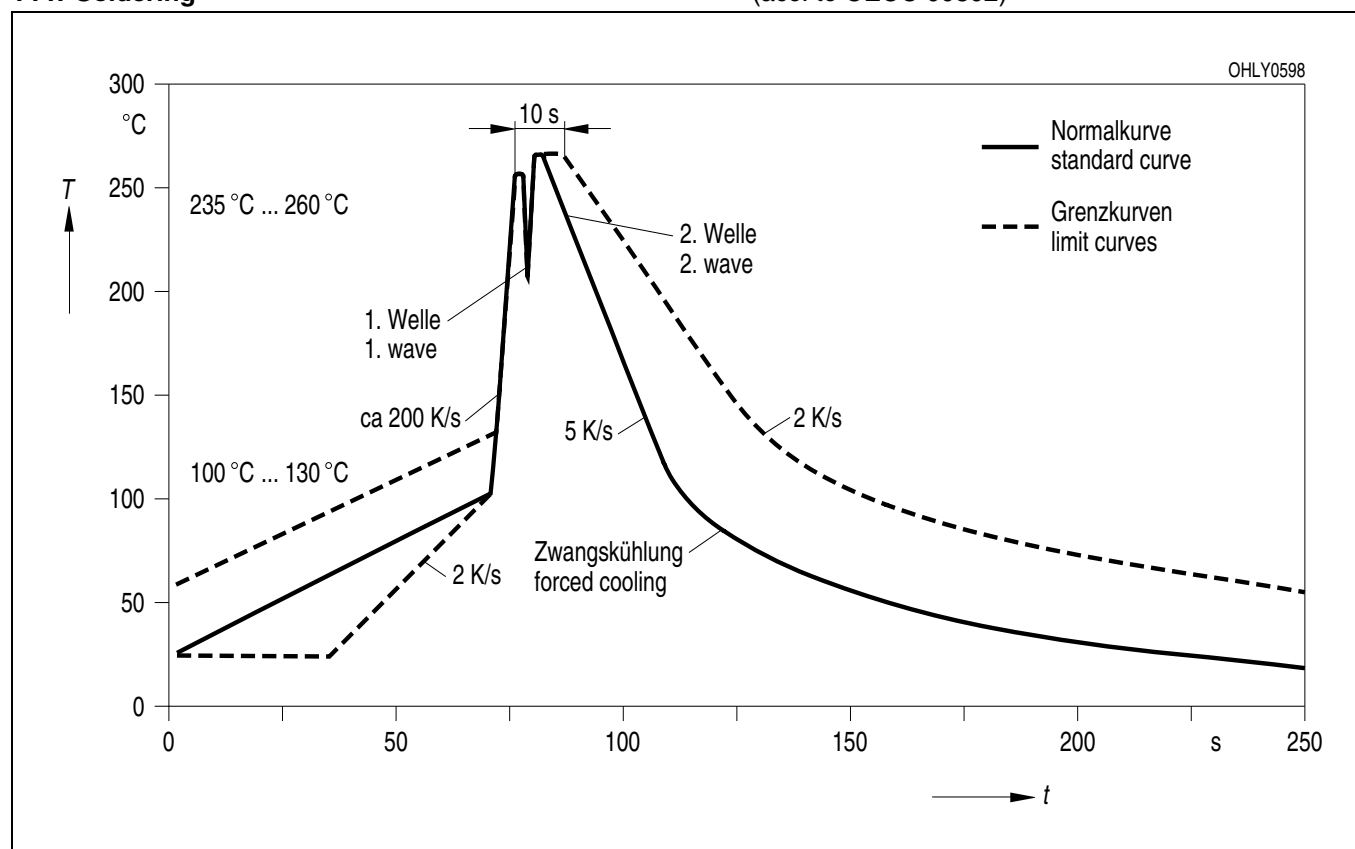

Published by
OSRAM Opto Semiconductors GmbH
 Wernerwerkstrasse 2, D-93049 Regensburg
www.osram-os.com

© All Rights Reserved.

The information describes the type of component and shall not be considered as assured characteristics. Terms of delivery and rights to change design reserved. Due to technical requirements components may contain dangerous substances. For information on the types in question please contact our Sales Organization.

Packing

Please use the recycling operators known to you. We can also help you – get in touch with your nearest sales office. By agreement we will take packing material back, if it is sorted. You must bear the costs of transport. For packing material that is returned to us unsorted or which we are not obliged to accept, we shall have to invoice you for any costs incurred.

Components used in life-support devices or systems must be expressly authorized for such purpose! Critical components¹, may only be used in life-support devices or systems² with the express written approval of OSRAM OS.

¹ A critical component is a component used in a life-support device or system whose failure can reasonably be expected to cause the failure of that life-support device or system, or to affect its safety or effectiveness of that device or system.

² Life support devices or systems are intended (a) to be implanted in the human body, or (b) to support and/or maintain and sustain human life. If they fail, it is reasonable to assume that the health of the user may be endangered.

EU RoHS and China RoHS compliant product



此产品符合欧盟 RoHS 指令的要求；

按照中国的相关法规和标准，不含有毒有害物质或元素。