



SK52F THRU SK5200F

SURFACE MOUNT SCHOTTKY BARRIER RECTIFIER

Reverse Voltage - 20 to 200 Volts Forward Current - 5.0 Ampere

SMAF

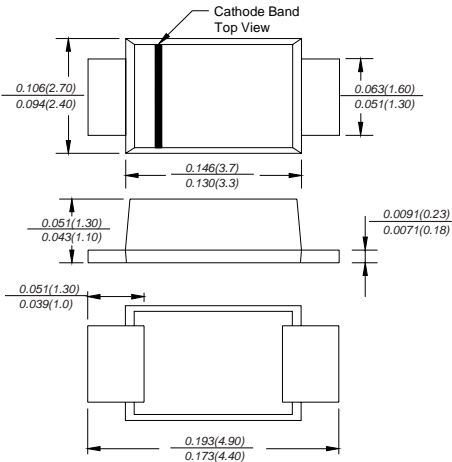

Dimensions in inches and (millimeters)

FEATURES

- ◆ The plastic package carries Underwriters Laboratory Flammability Classification 94V-0
- ◆ For surface mounted applications
- ◆ Metal silicon junction, majority carrier conduction
- ◆ Low power loss, high efficiency
- ◆ Built-in strain relief, ideal for automated placement
- ◆ High forward surge current capability
- ◆ High temperature soldering guaranteed: 260°C/10 seconds at terminals

MECHANICAL DATA

Case: JEDEC SMAF molded plastic body
Terminals: leads solderable per MIL-STD-750, Method 2026
Polarity: Color band denotes cathode end
Mounting Position: Any
Weight: 0.0018 ounce, 0.064 grams

MAXIMUM RATINGS AND ELECTRICAL CHARACTERISTICS

Ratings at 25°C ambient temperature unless otherwise specified.
 Single phase half-wave 60Hz, resistive or inductive load, for capacitive load current derate by 20%.

MDD Catalog Number	SYMBOLS	SK52F	SK53F	SK54F	SK55F	SK56F	SK58F	SKS510	SKS150F	SK5200F	UNITS	
Maximum repetitive peak reverse voltage	V_{RRM}	20	30	40	50	60	80	100	150	200	VOLTS	
Maximum RMS voltage	V_{RMS}	14	21	28	35	42	56	70	105	140	VOLTS	
Maximum DC blocking voltage	V_{DC}	20	30	40	50	60	80	100	150	200	VOLTS	
Maximum average forward rectified current at T_L (see fig.1)	I_{AV}	5.0									Amp	
Peak forward surge current 8.3ms single half sine-wave superimposed on rated load (JEDEC Method)	I_{FSM}	150.0									Amps	
Maximum instantaneous forward voltage at 5.0A	V_F	0.55		0.70		0.85		0.95		Volts		
Maximum DC reverse current at rated DC blocking voltage	I_R	0.5		20.0		10		2.0		mA		
Typical junction capacitance (NOTE 1)	C_J	200									pF	
Typical thermal resistance (NOTE 2)	$R_{\theta JA}$	50.0									°C/W	
Operating junction temperature range	T_J	-50 to +125					-50 to +150					°C
Storage temperature range	T_{STG}	-50 to +150									°C	

Note: 1. Measured at 1MHz and applied reverse voltage of 4.0V D.C.
 2. P.C.B. mounted with 0.2x0.2" (5.0x5.0mm) copper pad areas



www.micrediode.com

RATINGS AND CHARACTERISTIC CURVES SK52F THRU SK5200F

AVERAGE FORWARD RECTIFIED CURRENT, AMPERES

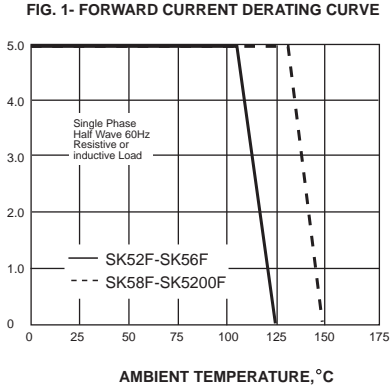

PEAK FORWARD SURGE CURRENT, AMPERES

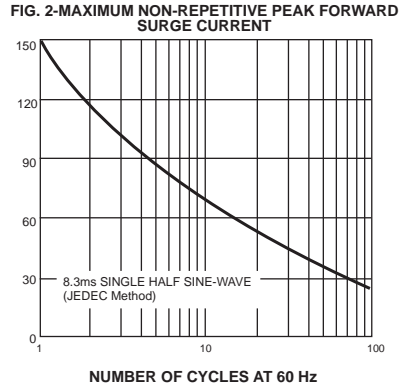

INSTANTANEOUS FORWARD CURRENT, AMPERES

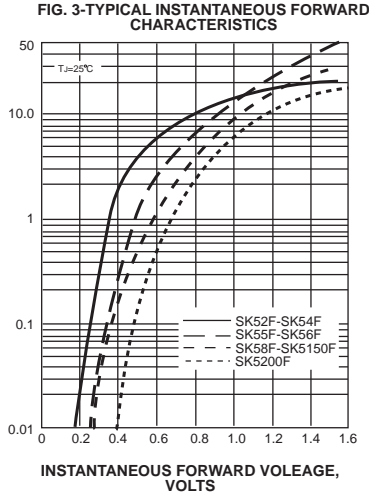

INSTANTANEOUS REVERSE CURRENT, MILLIAMPERES

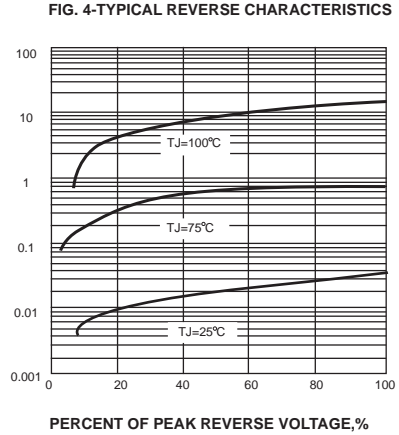

JUNCTION CAPACITANCE, pF

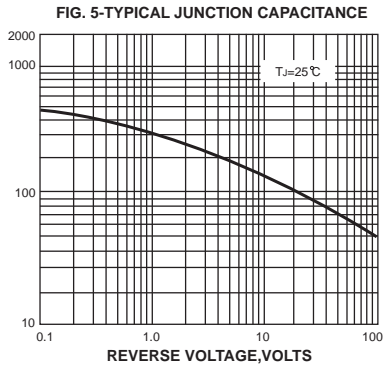

TRANSIENT THERMAL IMPEDANCE, °C/W

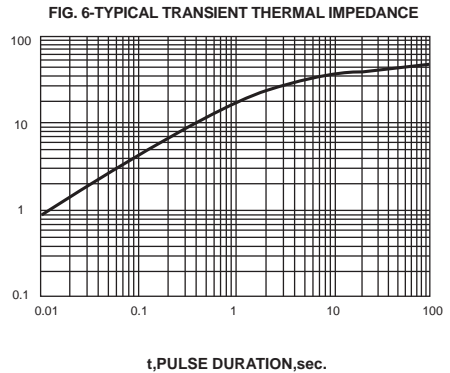

The cruve graph is for reference only, can't be the basis for judgment(曲线图仅供参考)!

