

## 600 WATT ULTRA LOW CAPACITANCE TVS ARRAY



**SOT-23 PACKAGE**

### DESCRIPTION

The SLVU2.8 is a low voltage, low leakage current and ultra low capacitance TVS device designed for EOS and ESD protection of low voltage circuits commonly found in network and computing applications. This device can be placed at the connector input or at the sensitive IC component and also be used across a single ended data line for the protection of a single line.

The SLVU2.8 device meets the IEC requirements of 61000-4-2 (ESD), 61000-4-4 (EFT) and 61000-4-5 (Surge). This device has a peak pulse power rating of 600 Watts (8/20 $\mu$ s waveform) and is available in a SOT-23 package configuration.

### FEATURES

- Compatible with IEC 61000-4-2 (ESD): Air 15kV, Contact 8kV
- Compatible with IEC 61000-4-4 (EFT): 40A, 5/50ns
- Compatible with IEC 61000-4-5 (Surge): 24A, 8/20 $\mu$ s - Level 2(Line-Ground) & Level 3(Line-Line)
- ESD Protection > 25 kilovolts
- 600 Watts Peak Pulse Power per Line( $t_p = 8/20\mu$ s)
- Unidirectional Configuration
- Protects 1 Line
- Low Leakage Current < 1.0 $\mu$ A
- Ultra Low Capacitance: 2.5pF
- RoHS Compliant
- REACH Compliant

### APPLICATIONS

- Ethernet 10/100/1000 Base T
- Routers and Switches
- Audio/Video Inputs
- Portable Electronics

### MECHANICAL CHARACTERISTICS

- Molded JEDEC SOT-23 Package
- Approximate Weight: 8 milligrams
- Lead-Free Pure-Tin Plating (Annealed)
- Solder Reflow Temperature:  
Pure-Tin - Sn, 100: 260-270°C
- Flammability Rating UL 94V-0
- 8mm Tape and Reel per EIA Standard 481

### PIN CONFIGURATION

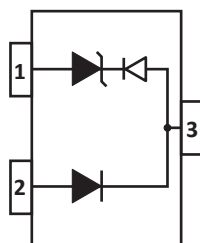

**TYPICAL DEVICE CHARACTERISTICS**
**MAXIMUM RATINGS @ 25°C Unless Otherwise Specified**

PARAMETER	SYMBOL	VALUE	UNITS
Peak Pulse Power (tp = 8/20μs) - See Figure 1	$P_{PP}$	600	Watts
Peak Pulse Current (tp = 8/20μs)	$I_{PP}$	30	Amps
Repetitive Peak Forward Current @ tp = 5μs, F=50kHz, Pin 2 to 3	$I_{FRM}$	700	mA
Operating Temperature	$T_L$	-55 to 150	°C
Storage Temperature	$T_{STG}$	-55 to 150	°C

**ELECTRICAL CHARACTERISTICS PER LINE @ 25°C Unless Otherwise Specified**

PART NUMBER (Note 1)	DEVICE MARKING	RATED STAND-OFF VOLTAGE $V_{WM}$ VOLTS	MINIMUM BREAKDOWN VOLTAGE @ 1mA $V_{(BR)}$ VOLTS	MINIMUM SNAP BACK VOLTAGE @ $I_{SB} = 50mA$ $V_{SB}$ VOLTS	MAXIMUM CLAMPING VOLTAGE (Fig. 2) @ $I_p = 2A$ $V_C$ VOLTS	MAXIMUM CLAMPING VOLTAGE (Fig. 2) @ $I_p = 5A$ $V_C$ VOLTS	MAXIMUM CLAMPING VOLTAGE (Fig. 2) @ $I_p = 30A$ $V_C$ VOLTS
SLVU2.8	SLA	2.8	3.0	2.8	3.9	7.0	21.0

**NOTES**

1. Device measured from pin 3 to 1.

**ELECTRICAL CHARACTERISTICS PER LINE @ 25°C Unless Otherwise Specified**

MAXIMUM CLAMPING VOLTAGE Pin 2 to 1 (Fig. 2) @ $I_p = 5A$ $V_C$ VOLTS	TYPICAL CLAMPING VOLTAGE Pin 2 to 1 (Fig. 2) @ $I_p = 30A$ $V_C$ VOLTS	MAXIMUM LEAKAGE CURRENT Pin 3 to 1 or Pin 2 to 1 @ $V_{WM}$ $I_D$ μA	TYPICAL CAPACITANCE Pin 3 to 1 & 2 (Tied Together) @ 0V, 1MHz C pF	TYPICAL CAPACITANCE Pin 2 to 1 3 N.C. @ 0V, 1MHz C pF	MAXIMUM PEAK REVERSE VOLTAGE Pin 3 to 2 (Note 1) @ $I_T = 10μA$ $V_{RRM}$ VOLTS	MAXIMUM REVERSE LEAKAGE VOLTAGE Pin 3 to 2 (Note 1) @ $V_{WM} = 2.8V$ $I_{DR}$ μA	MAXIMUM FORWARD VOLTAGE Pin 2 to 3 (Note 1) @ $I_F = 1A$ $T_p = 120μs$ $V_F$ VOLTS
8.5	21.0	1.0	20	2.5	40	0.1	2

**NOTES**

1. Electrical characteristics for steering diodes.

## TYPICAL DEVICE CHARACTERISTICS

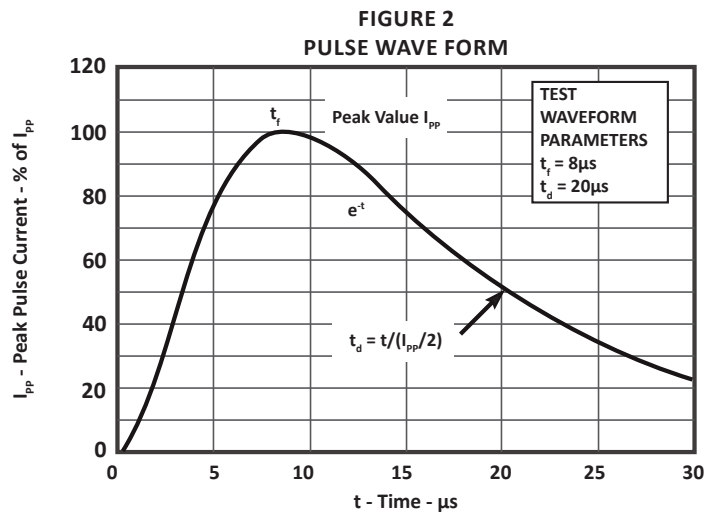
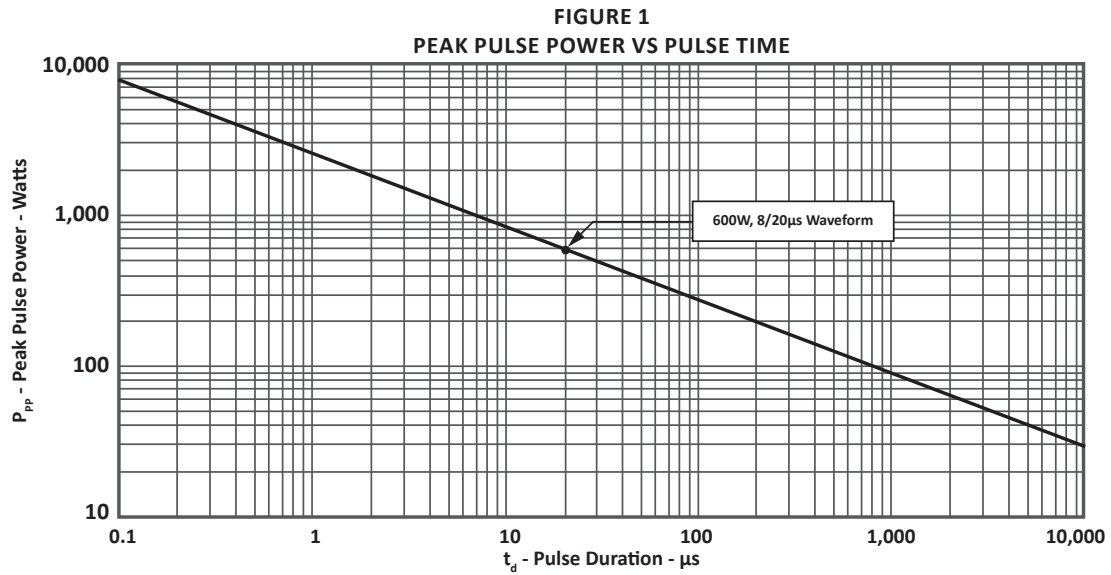

## TYPICAL DEVICE CHARACTERISTICS

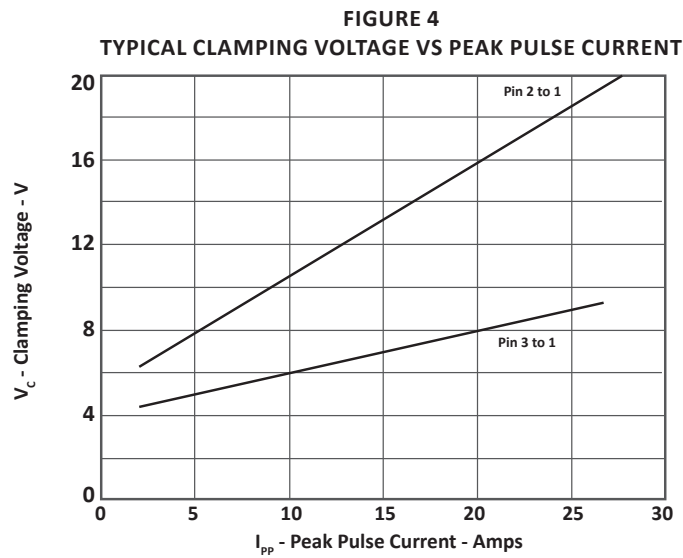
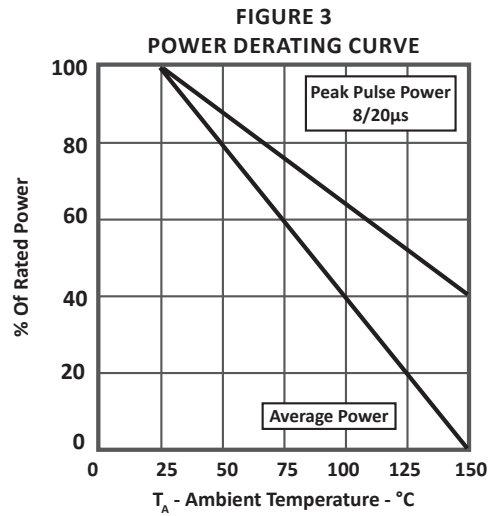

## SPICE MODEL

FIGURE 1  
SPICE MODEL

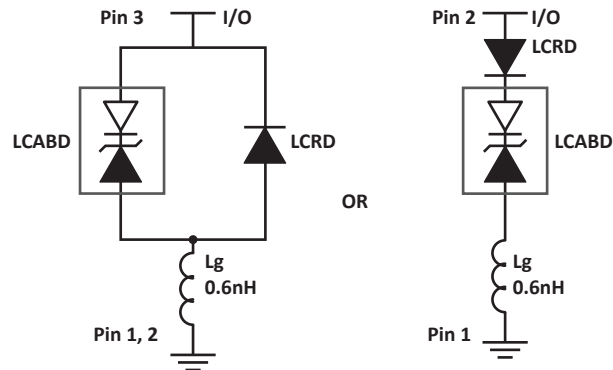

LCABD - Low Capacitance Avalanche Breakdown Diode (TVS)

LCRD: Low Capacitance Rectifier Diode

Lg - Lead Inductance

TABLE 1 - SPICE PARAMETERS

PARAMETER	UNIT	ABD(TVS)	LCRD
BV	V	3.3	200
IBV	$\mu\text{A}$	1	0.01
$C_{jo}$	pF	20	5
$I_s$	A	1E-11	1E-13
Vj	V	-	0.6
M	-	0.33	0.33
N	-	1	1
$R_s$	Ohms	0.28	0.31
TT	s	1E-8	1E-9
EG	eV	1.11	1.11

## APPLICATION INFORMATION

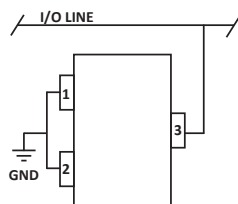

**FIGURE 1 - UNIDIRECTIONAL COMMON MODE PROTECTION**

Circuit connectivity is as follows:

- Line 1 connected to Pin 3.
- Pins 1 and 2 connected to ground.

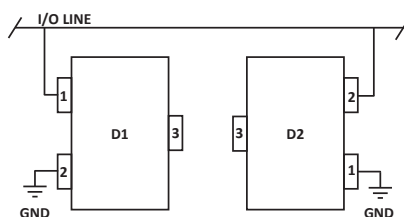

**FIGURE 2 - BIDIRECTIONAL COMMON MODE PROTECTION**

Two SLUV2.8 devices used in parallel. Circuit connectivity is as follows:

- Line 1 connected to Pin 1 of Device 1 and Pin 2 connected to Device 2.
- Pin 2 of Device 1 and Pin 1 of Device 2 connected to ground.
- Pin 3 of both Devices not connected.

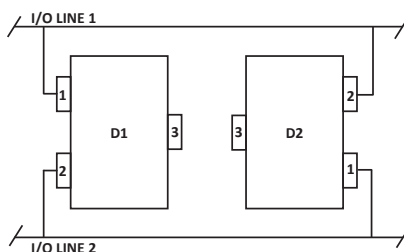

**FIGURE 3 - BIDIRECTIONAL DIFFERENTIAL MODE PROTECTION**

Two SLUV2.8 devices used in parallel. Circuit connectivity is as follows:

- Line 1 connected to Pin 1 of Device 1 and Pin 2 connected to Device 2.
- Line 2 connected to Pin 2 of Device 1 and Pin 1 of Device 2.
- Pin 3 not connected.

## CIRCUIT BOARD RECOMMENDATIONS

Circuit board layout is critical for electromagnetic compatibility protection. The following guidelines are recommended:

- The protection device should be placed near the input terminals or connectors, the device will divert the transient current immediately before it can be coupled into the nearby traces.
- The path length between the TVS device and the protected line should be minimized.
- All conductive loops including power and ground loops should be minimized.
- The transient current return path to ground should be kept as short as possible to reduce parasitic inductance.
- Ground planes should be used whenever possible. For multilayer PCBs, use ground vias.

**SOT-23 PACKAGE INFORMATION**
**OUTLINE DIMENSIONS**

DIM	MILLIMETERS		INCHES	
	MIN	MAX	MIN	MAX
A	2.80	3.04	0.110	0.120
B	1.20	1.40	0.047	0.055
C	0.89	1.11	0.035	0.044
D	0.37	0.50	0.015	0.020
G	1.78	2.04	0.070	0.081
H	0.013	0.100	0.001	0.004
J	0.085	0.177	0.003	0.007
K	0.45	0.60	0.018	0.024
L	0.89	1.02	0.035	0.040
S	2.10	2.50	0.083	0.098
V	0.45	0.60	0.018	0.024

**NOTES**

1. Controlling dimension: inches.
2. Dimensioning and tolerances per ANSI Y14.5M, 1985.
3. Pin 3 is the cathode (Unidirectional Only)
4. Dimensions are exclusive of mold flash and metal burrs.

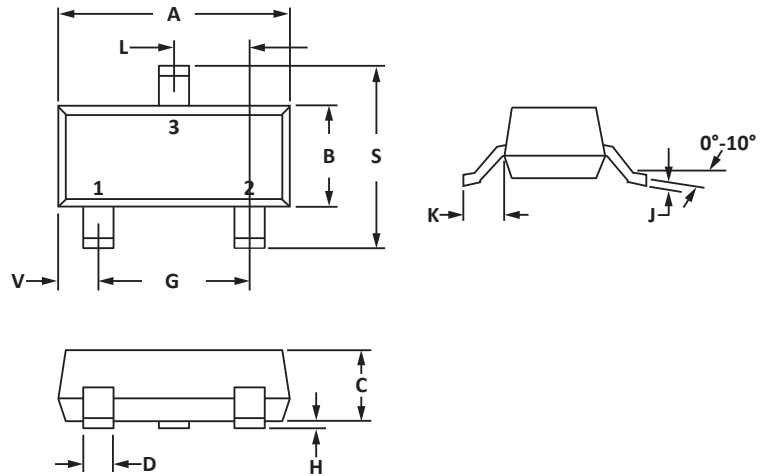
**PAD LAYOUT DIMENSIONS**

DIM	MILLIMETERS		INCHES	
	MIN	MAX	MIN	MAX
A	0.71	0.97	0.028	0.038
B	1.88	2.13	0.074	0.084
C	0.71	0.97	0.028	0.038
D	0.81	1.07	0.032	0.042

**NOTES**

1. Controlling dimension: inches.

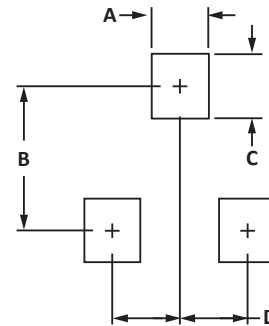

## TAPE AND REEL

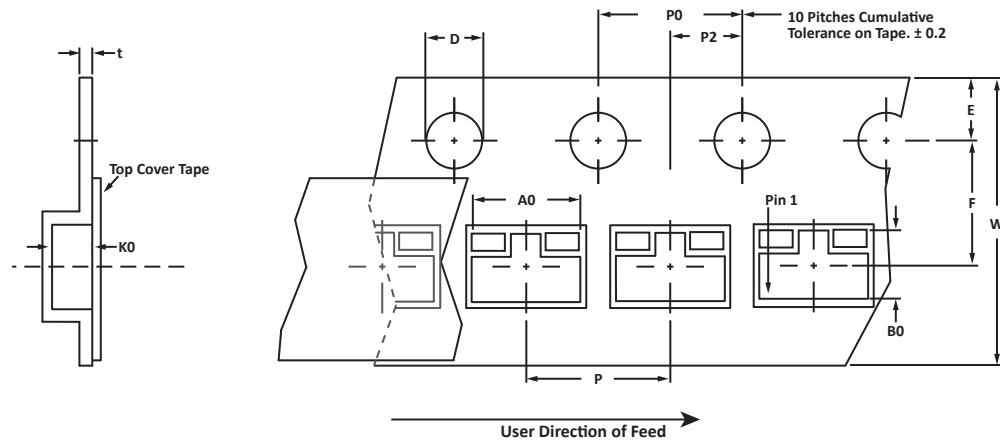

## SPECIFICATIONS

REEL DIA.	TAPE WIDTH	A0	B0	K0	D	E	F	W	P0	P2	P	tmax
178mm (7")	8mm	3.15 ± 0.10	2.77 ± 0.10	1.30 ± 0.10	1.55 ± 0.10	1.75 ± 0.10	3.50 ± 0.05	8.00 ± 0.30	4.00 ± 0.10	2.00 ± 0.05	4.00 ± 0.10	0.228

## NOTES

- Dimensions are in millimeters.
- Surface mount product is taped and reeled in accordance with EIA-481.
- Suffix - T7 = 7" Reel - 3,000 pieces per 8mm tape.
- Suffix - T13 = 13" Reel - 10,000 pieces per 8mm tape.
- Marking on Part - marking code (see page 2) and date code.

Package outline, pad layout and tape specifications per document number 06012.R2 8/10.

## ORDERING INFORMATION

BASE PART NUMBER	LEADFREE SUFFIX	TAPE SUFFIX	QTY/REEL	REEL SIZE	TUBE QTY
SLVU2.8	-LF	-T7	3,000	7"	n/a
SLVU2.8	-LF	-T13	10,000	13"	n/a



## COMPANY INFORMATION

---

### COMPANY PROFILE

ProTek Devices, based in Tempe, Arizona USA, is a manufacturer of Transient Voltage Suppression (TVS) products designed specifically for the protection of electronic systems from the effects of lightning, Electrostatic Discharge (ESD), Nuclear Electromagnetic Pulse (NEMP), inductive switching and EMI/RFI. With over 25 years of engineering and manufacturing experience, ProTek designs TVS devices that provide application specific protection solutions for all electronic equipment/systems.

ProTek Devices Analog Products Division, also manufactures analog interface, control, RF and power management products.

### CONTACT US

#### Corporate Headquarters

2929 South Fair Lane  
Tempe, Arizona 85282  
USA

#### By Telephone

General: 602-431-8101  
Sales: 602-414-5109  
Customer Service: 602-414-5114

#### By Fax

General: 602-431-2288

#### By E-mail:

Sales: [sales@protekdevices.com](mailto:sales@protekdevices.com)  
Customer Service: [service@protekdevices.com](mailto:service@protekdevices.com)  
Technical Support: [support@protekdevices.com](mailto:support@protekdevices.com)

#### Web

[www.protekdevices.com](http://www.protekdevices.com)  
[www.protekanalog.com](http://www.protekanalog.com)

COPYRIGHT © ProTek Devices 2001 - This literature is subject to all applicable copyright laws and is not for resale in any manner.

SPECIFICATIONS: ProTek reserves the right to change the electrical and or mechanical characteristics described herein without notice.

DESIGN CHANGES: ProTek reserves the right to discontinue product lines without notice and that the final judgement concerning selection and specifications is the buyer's and that in furnishing engineering and technical assistance. ProTek assumes no responsibility with respect to the selection or specifications of such products. ProTek makes no warranty, representation or guarantee regarding the suitability of its products for any particular purpose, nor does ProTek assume any liability arising out of the application or use of any product or circuit and specifically disclaims any and all liability without limitation special, consequential or incidental damages.

LIFE SUPPORT POLICY: ProTek Devices products are not authorized for use in life support systems without written consent from the factory.