

TRANSIENT VOLTAGE SUPPRESSOR

SMAJ5.0--SMAJ440CA

FEATURES

- Plastic package has underwriters laboratory flammability classification 94V-0
- Optimized for LAN protection applications
- Low profile package with built-in strain relief for surface mounted applications
- Low incremental surge resistance, excellent clamping capability
- 400W peak pulse power capability with a 10/1000 μ s wave
- form, repetition rate (duty cycle): 0.01% (300W above 78V)
- Very fast response time
- High temperature soldering guaranteed: 250° C/ 10 seconds at terminals



MECHANICAL DATA

- Case: JEDEC DO-214AC molded plastic over passivated chip
- Terminals: solder plated, solderable per MIL-STD-750, method 2026
- Polarity: for uni-directional types the color band denotes the cathode, which is positive with respect to the anode under normal TVS operation
- Mounting position: any Weight: 0.002 ounces, 0.064 grams

Devices for Bidirectional Applications

For bi-directional devices, use suffix C or CA (e.g. SMAJ10C, SMAJ10CA). Electrical characteristics apply in both directions.

Maximum Ratings and Thermal Characteristics (T_A=25°C unless otherwise noted)

Characteristic	Symbol	Value	Unit
Peak power dissipation with a 10/1000 μ s waveform (NOTE 1,2, FIG.1)	P _{PPM}	Minimum 400	W
Peak pulse current with a 10/1000 μ s waveform (NOTE 1)	I _{PPM}	See next table	A
Typical thermal resistance, junction to ambient (NOTE 3)	R _{θJA}	120.0	°C/W
Peak forward surge current, 8.3ms single half sine-wave uni-directional only (NOTE 2)	I _{FSM}	40.0	A
Typical thermal resistance, junction to ambient (NOTE 3)	R _{θJL}	30	°C/W
Operating junction and storage temperature range	T _J , T _{STG}	-55---+150	°C

NOTES: (1) Non-repetitive current pulses, per Fig. 3 and derate above T_A=25 per Fig. 2. Rating is 300W above 78V.

(2) Mounted on 0.2 x 0.2" (5.0 x 5.0mm) copper pads to each terminal.

(3) Mounted on minimum recommended pad layout.

TRANSIENT VOLTAGE SUPPRESSOR**SMAJ5.0--SMAJ440CA****ELECTRICAL CHARACTERISTICS** ($T_A=25^\circ\text{C}$)

Type	Device marking code		Dynamic			V_{WM}	I_{RM}	I_{PPM}	VC
	UNI	BI	V		@ I_T				
			Min	Max	m A	V	μ A	A	V
SMAJ5.0	AAD	AWD	6.4	7.81	10	5.0	800	41.7	9.6
SMAJ5.0A	AAE	AWE	6.4	7.08	10	5.0	800	43.5	9.2
SMAJ6.0	AAF	AWF	6.67	8.15	10	6.0	800	35.1	11.4
SMAJ6.0A	AAG	AWG	6.67	7.37	10	6.0	800	38.8	10.3
SMAJ6.5	AAH	AWH	7.22	8.82	10	6.5	500	32.5	12.3
SMAJ6.5A	AAK	AWK	7.22	7.98	10	6.5	500	35.7	11.2
SMAJ7.0	AAL	AWL	7.78	9.51	10	7.0	200	30.1	13.3
SMAJ7.0A	AAM	AWM	7.78	8.6	10	7.0	200	33.3	12
SMAJ7.5	AAN	AWN	8.33	10.3	1.0	7.5	100	28.0	14.3
SMAJ7.5A	AAP	AWP	8.33	9.21	1.0	7.5	100	31.0	12.9
SMAJ8.0	AAQ	AWQ	8.89	10.9	1.0	8.0	50	26.7	15.0
SMAJ8.0A	AAR	AWR	8.89	9.83	1.0	8.0	50	29.4	13.6
SMAJ8.5	AAS	AWS	9.44	11.5	1.0	8.5	10	25.2	15.9
SMAJ8.5A	AAT	AWT	9.44	10.4	1.0	8.5	10	27.8	14.4
SMAJ9.0	AAU	AWU	10.0	12.2	1.0	9.0	5.0	23.7	16.9
SMAJ9.0A	AAV	AWV	10.0	11.1	1.0	9.0	5.0	26.0	15.4
SMAJ10	AAW	AWW	11.1	13.6	1.0	10	5.0	21.3	18.8
SMAJ10A	AAX	AWX	11.1	12.3	1.0	10	5.0	23.5	17.0
SMAJ11	AAY	AWY	12.2	14.9	1.0	11	5.0	19.9	20.1
SMAJ11A	AAZ	AWZ	12.2	13.5	1.0	11	5.0	22.0	18.2
SMAJ12	ABD	AXD	13.3	16.3	1.0	12	5.0	18.2	22.0
SMAJ12A	ABE	AXE	13.3	14.7	1.0	12	5.0	20.1	19.9
SMAJ13	ABF	AXF	14.4	17.6	1.0	13	5.0	16.8	23.8
SMAJ13A	ABG	AXG	14.4	15.9	1.0	13	5.0	18.6	21.5
SMAJ14	ABH	AXH	15.6	19.1	1.0	14	5.0	15.5	25.8
SMAJ14A	ABK	AXK	15.6	17.2	1.0	14	5.0	17.2	23.2
SMAJ15	ABL	AXL	16.7	20.4	1.0	15	5.0	14.9	26.9
SMAJ15A	ABM	AXM	16.7	18.5	1.0	15	5.0	16.4	24.4
SMAJ16	ABN	AXN	17.8	21.8	1.0	16	5.0	13.9	28.8
SMAJ16A	ABP	AXP	17.8	19.7	1.0	16	5.0	15.4	26
SMAJ17	ABQ	AXQ	18.9	23.1	1.0	17	5.0	13.1	30.5
SMAJ17A	ABR	AXR	18.9	20.9	1.0	17	5.0	14.5	27.6
SMAJ18	ABS	AXS	20.0	24.4	1.0	18	5.0	12.4	32.2
SMAJ18A	ABT	AXT	20.0	22.4	1.0	18	5.0	13.7	39.2

TRANSIENT VOLTAGE SUPPRESSOR**SMAJ5.0--SMAJ440CA**

Type	Device marking code		Dynamic			V_{WM}	I_{RM}	I_{PPM}	VC
	UNI	BI	V		@ I_T				
			Min	Max	m A	V	V_{WM} u A	A	I_{PPM} V
SMAJ20	ABU	AXU	22.2	27.1	1.0	20	5.0	11.2	35.8
SMAJ20A	ABV	AXV	22.2	24.5	1.0	20	5.0	12.3	32.4
SMAJ22	ABW	AXW	24.4	29.8	1.0	22	5.0	10.2	39.4
SMAJ22A	ABX	AXX	24.4	26.9	1.0	22	5.0	11.3	35.5
SMAJ24	ABY	AXY	26.7	32.6	1.0	24	5.0	9.3	43.0
SMAJ24A	ABZ	AXZ	26.7	29.5	1.0	24	5.0	10.3	38.9
SMAJ26	ACD	AYD	28.9	35.3	1.0	26	5.0	8.6	46.6
SMAJ26A	ACE	AYE	28.9	31.9	1.0	26	5.0	9.5	42.1
SMAJ28	ACF	AYF	31.3	38	1.0	28	5.0	8.0	50.0
SMAJ28A	ACG	AYG	31.3	34.4	1.0	28	5.0	8.8	45.4
SMAJ30	ACH	AYH	33.3	40.7	1.0	30	5.0	7.5	53.5
SMAJ30A	ACK	AYK	33.3	36.8	1.0	30	5.0	8.3	48.4
SMAJ33	ACL	AYL	36.7	44.9	1.0	33	5.0	5.1	59.0
SMAJ33A	ACM	AYM	36.7	40.6	1.0	33	5.0	5.6	53.3
SMAJ36	ACN	AYN	40.0	48.9	1.0	36	5.0	4.7	64.3
SMAJ36A	ACP	AYP	40.0	44.2	1.0	36	5.0	5.2	58.1
SMAJ40	ACQ	AYQ	44.4	54.3	1.0	40	5.0	4.2	71.4
SMAJ40A	ACR	AYR	44.4	49.1	1.0	40	5.0	4.7	64.5
SMAJ43	ACS	AYS	47.8	58.4	1.0	43	5.0	3.9	76.7
SMAJ43A	ACT	AYT	47.8	52.8	1.0	43	5.0	4.3	69.4
SMAJ45	ACU	AYU	50.0	61.1	1.0	45	5.0	3.7	80.3
SMAJ45A	ACV	AYV	50.0	55.3	1.0	45	5.0	4.1	72.7
SMAJ48	ACW	AYW	53.3	65.1	1.0	48	5.0	3.5	85.5
SMAJ48A	ACX	AYX	53.3	58.9	1.0	48	5.0	3.9	77.4
SMAJ51	ACY	AYY	56.7	69.3	1.0	51	5.0	3.3	91.1
SMAJ51A	ACZ	AYZ	56.7	62.7	1.0	51	5.0	3.6	82.4
SMAJ54	ARD	AZD	60.0	73.3	1.0	54	5.0	3.1	96.3
SMAJ54A	ARE	AZE	60.0	66.3	1.0	54	5.0	3.4	87.1
SMAJ58	ARF	AZF	64.4	78.7	1.0	58	5.0	2.9	103
SMAJ58A	ARG	AZG	64.4	71.2	1.0	58	5.0	3.2	93.6
SMAJ60	ARH	AZH	66.7	81.5	1.0	60	5.0	2.8	107
SMAJ60A	ARK	AZK	66.7	73.7	1.0	60	5.0	3.1	96.8
SMAJ64	ARL	AZL	71.1	86.9	1.0	64	5.0	2.6	114
SMAJ64A	ARM	AZM	71.1	78.6	1.0	64	5.0	2.9	103
SMAJ70A	ARP	AZP	77.8	86	1.0	70	5.0	2.7	113
SMAJ75	ARQ	AZQ	83.3	102	1.0	75	5.0	2.2	134
SMAJ75A	ARR	AZR	83.3	92.1	1.0	75	5.0	2.5	121
SMAJ78	ARS	AZS	86.7	106	1.0	78	5.0	2.2	139
SMAJ78A	ART	AZT	86.7	95.8	1.0	78	5.0	2.4	126

TRANSIENT VOLTAGE SUPPRESSOR**SMAJ5.0--SMAJ440CA**

Type	Device marking code		Dynamic			V _{WM}	I _{RM}	I _{PPM}	V _C
	UNI	BI	V		@I _T		V _{WM}		I _{PPM}
			Min	Max	m A	V	u A	A	v
SMAJ85	ARU	AZU	94.4	115	1.0	85	5.0	2.0	151
SMAJ85A	ARV	AZV	94.4	104	1.0	85	5.0	2.2	137
SMAJ90A	ARX	AZX	100	111	1.0	90	5.0	2.1	146
SMAJ100	ARY	AZY	111	136	1.0	100	5.0	1.7	179
SMAJ100A	ARZ	AZZ	111	123	1.0	100	5.0	1.9	162
SMAJ110	ASD	AVD	122	149	1.0	110	5.0	1.5	196
SMAJ110A	ASE	AVE	122	135	1.0	110	5.0	1.7	177
SMAJ120	ASF	AVF	133	163	1.0	120	5.0	1.4	214
SMAJ120A	ASG	AVG	133	147	1.0	120	5.0	1.6	193
SMAJ130	ASH	AVH	144	176	1.0	130	5.0	1.3	231
SMAJ130A	ASK	AVK	144	159	1.0	130	5.0	1.4	209
SMAJ150	ASL	AVL	167	204	1.0	150	5.0	1.1	268
SMAJ150A	ASM	AVM	167	185	1.0	150	5.0	1.2	243
SMAJ160	ASN	AVN	178	218	1.0	160	5.0	1.0	287
SMAJ160A	ASP	AVP	178	197	1.0	160	5.0	1.2	259
SMAJ170	ASQ	AVQ	189	231	1.0	170	5.0	1.0	304
SMAJ170A	ASR	AVR	189	209	1.0	170	5.0	1.1	275
SMAJ180	ATW	AUW	200	245	1.0	180	5.0	1.2	321
SMAJ180A	ATX	AUX	200	221	1.0	180	5.0	1.4	291
SMAJ188	AST	AVT	209	255	1.0	188	5.0	0.9	344
SMAJ188A	ASS	AVS	209	231	1.0	188	5.0	0.9	328
SMAJ200	ASU	AVU	222	272	1.0	200	5.0	1.1	356
SMAJ200A	ASV	AVV	222	246	1.0	200	5.0	1.2	323
SMAJ220	ASW	AVW	245	299	1.0	220	5.0	1.0	392
SMAJ220A	ASX	AVX	245	270	1.0	220	5.0	1.0	355
SMAJ240	ASY	AVY	267	326	1.0	240	5.0	0.9	428
SMAJ240A	ASZ	AVZ	267	295	1.0	240	5.0	1.0	388
SMAJ250	ATS	AXS	278	340	1.0	250	5.0	0.9	446
SMAJ250A	ATT	AXT	278	307	1.0	250	5.0	1.0	404
SMAJ300	ATF	AXF	333	408	1.0	300	5.0	0.7	535
SMAJ300A	ATG	AXG	333	368	1.0	300	5.0	0.8	485
SMAJ350	ATQ	AXQ	389	476	1.0	350	5.0	0.6	624
SMAJ350A	ATR	AXR	389	430	1.0	350	5.0	0.7	565
SMAJ360	ATH	AXH	400	489	1.0	360	5.0	0.6	642
SMAJ360A	ATK	AXK	400	442	1.0	360	5.0	0.7	582
SMAJ400	ATL	AXL	445	544	1.0	400	5.0	0.6	713
SMAJ400A	ATM	AXM	445	491	1.0	400	5.0	0.6	646
SMAJ440	ATN	AXN	489	598	1.0	440	5.0	0.5	784
SMAJ440A	ATP	AXP	489	540	1.0	440	5.0	0.6	711

TRANSIENT VOLTAGE SUPPRESSOR

SMAJ5.0--SMAJ440CA

PACKAGE OUTLINE DIMENSIONS

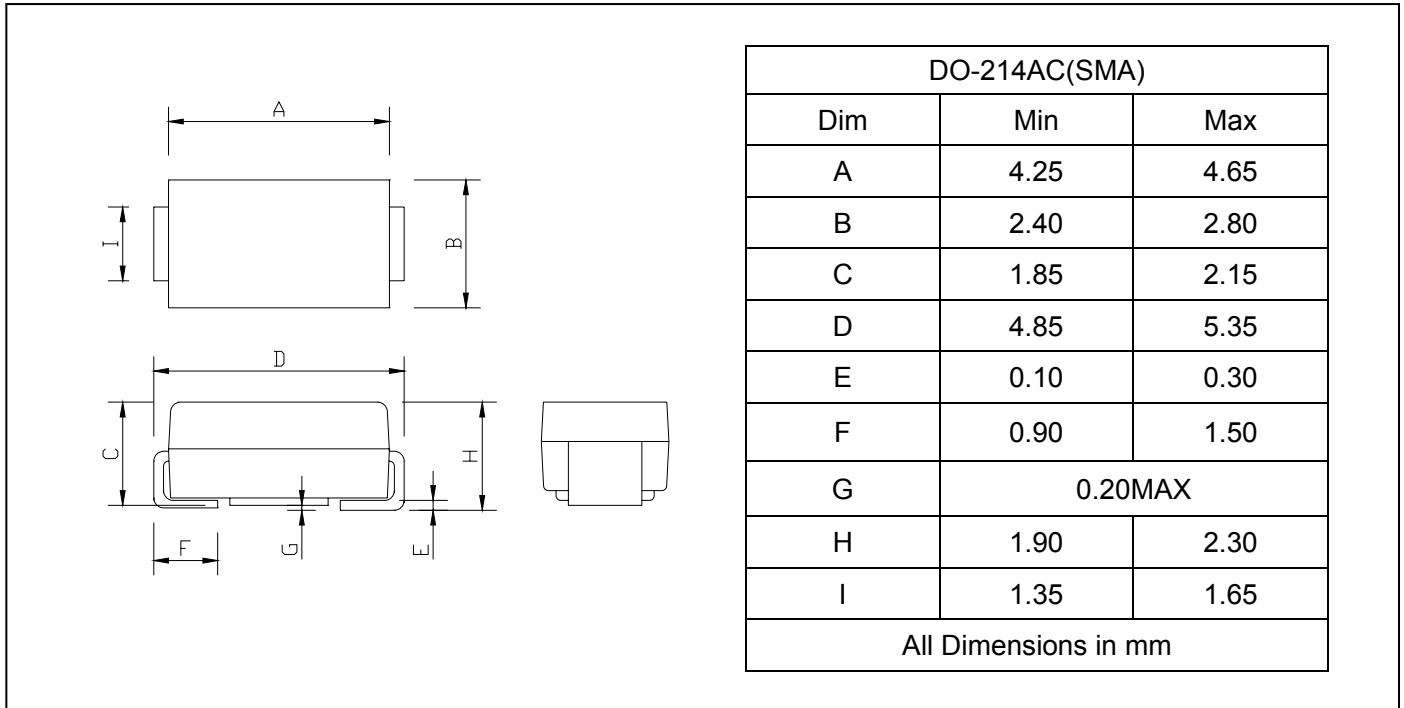

SOLDERING FOOTPRINT

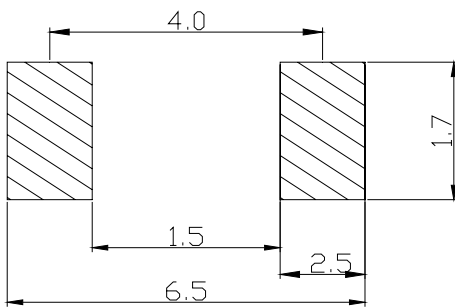

Unit : mm

PACKAGE INFORMATION

Device	Package	Shipping
SMAJ5.0-SMAJ440CA	DO-214AC(SMA)	5000/Tape&Reel



TRANSIENT VOLTAGE SUPPRESSOR

SMAJ5.0--SMAJ440CA

FIG.1 -- PEAK PULSE POWER RATING CURVE

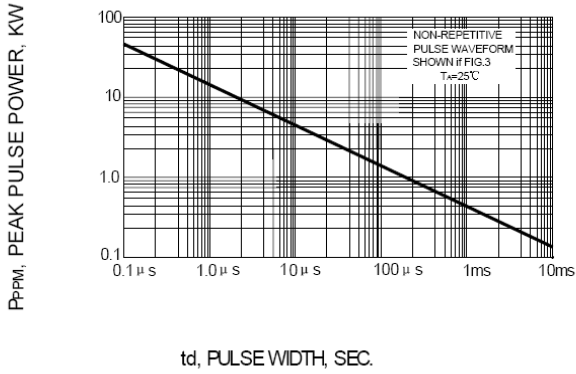

FIG.2 -- PULSE DERATING CURVE

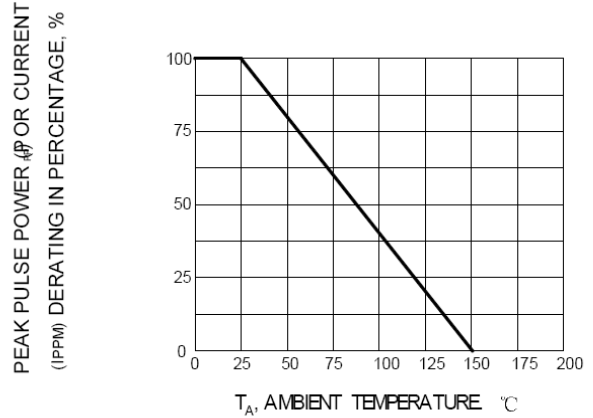

FIG.3 -- PULSE WAVEFORM

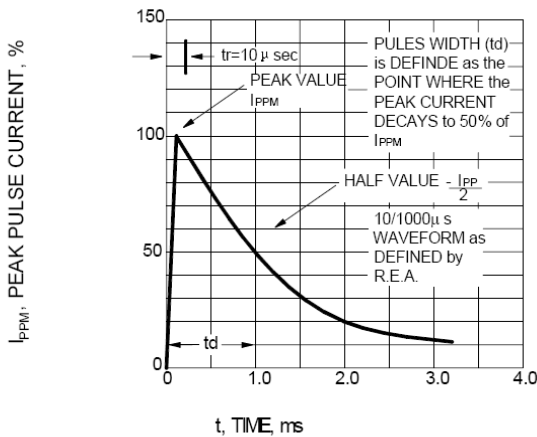

FIG.4 -- TYPICAL JUNCTION CAPACITANCE UNIDIRECTIONAL

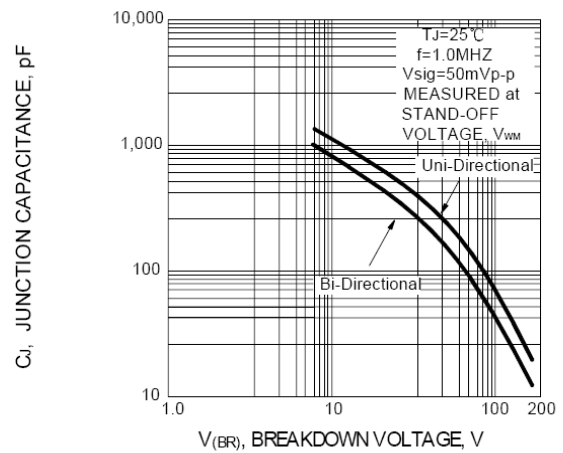

FIG.5 -- TYPICAL TRANSIENT THERMAL IMPEDANCE

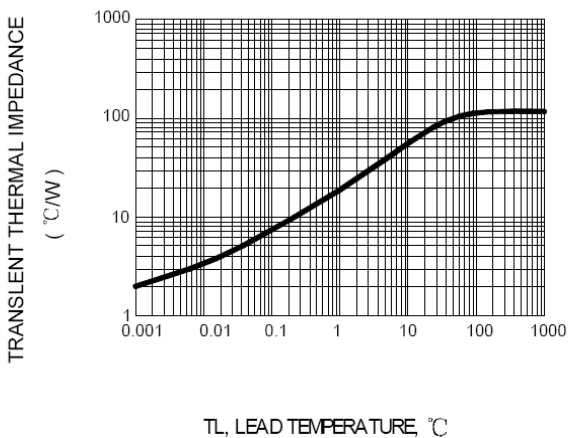

FIG.6 -- MAXIMUM NON-REPETITIVE FORWARD SURGE CURRENT UNIDIRECTIONAL ONLY

