



# SPX2730/31/32/33

## 3A High Current Low Dropout Voltage Regulator Adjustable & Fixed Output, Fast Response (ADVANCED INFORMATION)

### FEATURES

- Adjustable Output Down To 1.2V
- 1% output accuracy @ 3.3V, 5.0V
- Output Current of 3A
- Low Dropout Voltage 370mV(Typ.) @ 3A.
- Extremely Tight Load And Line Regulation
- Extremely Fast Transient Response
- Standard 3-Terminal Low Cost TO-220, TO-263
- Reverse-battery and "Load Dump" Protection
- Zero Current Shutdown Mode (5-Pin Versions)
- Error Flag Signal Output Out-of Regulation (5-Pin Versions)

### APPLICATIONS

- Powering VGA & Sound Card
- Power PC™ Supplies
- SMPS Post-Regulator
- High Efficiency "Green" Computer Systems
- High Efficiency Linear Power Supplies
- Portable Instrumentation
- Constant Current Regulators
- Adjustable Power Supplies
- Battery charger

### PRODUCT DESCRIPTION

The SPX2730/31/32/33 is a 3A high accuracy, low dropout voltage regulator (370mV(Typ)@ 3A). The SPX2730/31/32/33 is designed for low voltage application that requires lower dropout voltage and faster transient response. This device is an excellent choice for use in powering low voltage microprocessor that require a lower dropout, faster transient response to regulate from +2.5V to 3.8V supplies and as a post regulator for switching supplies applications.

The SPX2730/31/32/33 offers full protection against over-current faults, reversed input polarity, reversed load insertion, and positive and negative transient voltage. On-Chip trimming adjusts the reference voltage to 1%. Features such as enable pin, Error flag pin are also included in the 5-pin package.

The SPX2730/31/32/33 are offered in 3 & 5 pin TO-220 & TO-263 packages compatible with other 3 terminal regulators.

### PIN CONNECTIONS

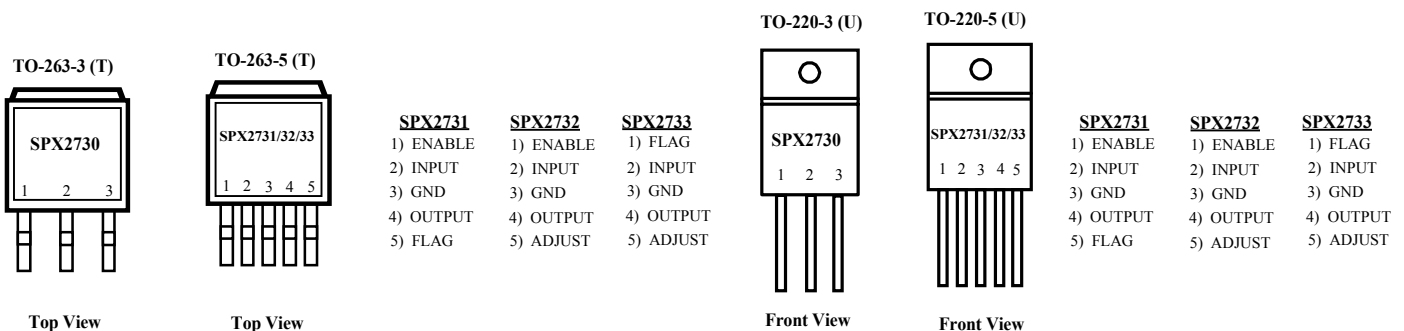

## ABSOLUTE MAXIMUM RATINGS

Lead Temp. (Soldering, 5 Seconds) .....	260°C
Storage Temperature Range .....	-65° to +150°C
Operating Junction Temperature Range	
SPX2730/31/32/33 Control Section .....	-45°C +125°C
SPX2730/31/32/33 Power Transistor .....	-45°C +150°C

Maximum Input Voltage ..... 16V

## ELECTRICAL CHARACTERISTICS (NOTE 1) at I<sub>OUT</sub> = 10mA, T<sub>a</sub> = 25°C, unless otherwise specified.

PARAMETER	CONDITIONS	Typ	SPX2730/31/32/33		Units
			Min	Max	
<b>3.3V Version</b>					
Output Voltage (Note 2)	I <sub>OUT</sub> = 10mA 10mA ≤ I <sub>OUT</sub> ≤ 3A, 4.75V ≤ V <sub>IN</sub> ≤ 16V	3.3 <b>3.3</b>	3.270 <b>3.240</b>	3.330 <b>3.360</b>	V
<b>5.0V Version</b>					
Output Voltage (Note 2)	I <sub>OUT</sub> = 10mA 10mA ≤ I <sub>OUT</sub> ≤ 3A, 5.5V ≤ V <sub>IN</sub> ≤ 16V	5.0 <b>5.0</b>	4.95 <b>4.90</b>	5.05 <b>5.10</b>	V
<b>All Voltage Options</b>					
Reference Voltage		1.240	1.228 <b>1.215</b>	1.252 <b>1.265</b>	V
Reference Voltage	(Note 8)		<b>1.203</b>	<b>1.277</b>	V
Line Regulation	I <sub>O</sub> = 10mA, (V <sub>OUT</sub> + 1V) ≤ V <sub>IN</sub> ≤ 16V	0.06		0.5	%
Load Regulation	V <sub>IN</sub> = V <sub>OUT</sub> + 5V, 10mA ≤ I <sub>OUT</sub> ≤ I <sub>FULLLOAD</sub> (Note 2, 6)	0.2		1	%
$\frac{\Delta V}{\Delta T}$	Output Voltage (Note 6) Temperature Coef.	<b>20</b>		<b>100</b>	ppm/°C
Dropout Voltage	I <sub>O</sub> = 100mA	80		<b>175</b>	mV
	I <sub>O</sub> = 1.5A	250			
	I <sub>O</sub> = 3A	370		<b>600</b>	
Ground Current	I <sub>O</sub> = 1.5A, V <sub>IN</sub> = V <sub>OUT</sub> + 1V	10		<b>35</b>	mA
	I <sub>O</sub> = 3A	37			
I <sub>GNDDO</sub> Ground Pin Current at Dropout	V <sub>IN</sub> = 0.5V less than specified V <sub>OUT</sub> I <sub>OUT</sub> = 10mA	0.9			mA
Current Limit	V <sub>OUT</sub> = 0V (Note 4)	4.5	3.0		A
Output Noise Voltage (10Hz to 100kHz)	C <sub>L</sub> = 10μF	400			V <sub>RMS</sub>
	I <sub>L</sub> = 100mA C <sub>L</sub> = 33μF	260			
Adjust Pin Bias Current		40		80 <b>120</b>	nA
Reference Voltage Temperature Coefficient	(Note 7)	20			ppm/°C
Adjust Pin Bias Current Temperature Coefficient		0.1			nA/°C
<b>Flag Output (Error Comparator) SPX2731/SPX2733</b>					
Output Leakage Current	V <sub>OH</sub> = 16V	0.01		1.00 <b>2.00</b>	μA
Output Low Voltage	Device set for 5V. V <sub>IN</sub> = 4.5V I <sub>OL</sub> = 250μA	220		300 <b>400</b>	mV

(Cont.)

Upper Threshold Voltage	Device set for 5V (Note 9)	60	40 <b>25</b>		mV
Lower Threshold Voltage	Device set for 5V (Note 9)	75		95 <b>140</b>	mV
Hysteresis	Device set for 5V (Note 9)	15			mV
<b>ENABLE Input SPX2731/SPX2732</b>					
Input Logic Voltage Low (OFF) High (ON)			<b>2.4</b>	<b>0.8</b>	V
Enable Pin Input Current	$V_{EN} = 16V$	100		600 <b>750</b>	V
	$V_{EN} = 0.8V$			1 <b>2</b>	$\mu A$
Regulator Output Current in Shutdown	(Note 10)	10		500	$\mu A$

**Notes:**

The Bold specifications apply to the full operating temperature range.

Note 1: Maximum positive supply voltage of 60V must be of limited duration (<100msec) and duty cycle.) The maximum continuous supply voltage is 16V.

Note 2: Full load current ( $I_{FL}$ ) is defined as 1.5A for the

Note 3: Dropout voltage is defined as the input-to output differential when the output voltage drops to 99% of its nominal value with  $V_{OUT} + 1V$  applied to  $V_{IN}$ .

Note 4:  $V_{IN} = V_{OUT (NOMINAL)} + 1V$ . For example, use  $V_{IN} = 4.3V$  for a 3.3V regulator. Employ pulse-testing procedures to minimize temperature rise.

Note 5: Ground pin current is the regulator quiescent current. The total current drawn from the source is the sum of the load current to the ground current.

Note 6: Output voltage temperature coefficient is defined as the worst case voltage changed divided by the total temperature range.

Note 7: Thermal regulation is defined as the change in the output voltage at a time T after a change in power dissipation is applied, excluding load or line regulation effects. Specifications are for a 200mA load pulse as  $V_{IN} = 20V$  (a 4W pulse) for  $T = 10ms$ .

Note 8:  $V_{REF} \leq V_{OUT} \leq (V_{IN} - 1)$ ,  $2.3V \leq V_{IN} \leq 16V$ ,  $10mA < I_L \leq I_{FL}$ ,  $T_J \leq T_{JMAX}$

Note 9: Comparator threshold is expressed in terms of a voltage differential at the Adjust terminal below the nominal reference voltage measured a 6V input. To express these thresholds in terms of output voltage change, multiply the error amplifier gain =  $V_{OUT}/V_{REF} = (R1 + R2)/R2$ . For example, at a programmable output voltage of 5V, the Error output is guaranteed to go low when the output drops by  $95mV \times 5V / 1.240V = 38mV$ . Threshold remain constant as a percent of  $V_{OUT}$  as  $V_{OUT}$  is varied, with the dropout warning occurring at typically 5% below nominal, 7.7% guaranteed.

Note 10:  $V_{EN} \leq 0.8V$  and  $V_{IN} \leq 16V$ ,  $V_{OUT} = 0$ .

## APPLICATION HINTS

The SPX2730/31/32/33 incorporates protection against over-current faults, reversed load insertion, over temperature operation, and positive and negative transient voltage. However, the use of an output capacitor is required in order to insure the stability and the performances.

### Thermal Consideration

Although the SPX2730/31/32/33 offers limiting circuitry for overload conditions, it is necessary not to exceed the maximum junction temperature, and therefore to be careful about thermal resistance. The heat flow will follow the lowest resistance path, which is the Junction-to-case thermal resistance. In order to insure the best thermal flow of the component, a proper mounting is required. Note that the case of the device is electrically connected to the output. The case has to be electrically isolated, a thermally conductive spacer can be used. However do not forget to consider its contribution to thermal resistance.

Assuming:

$$V_{IN} = 10V, V_{OUT} = 5V, I_{OUT} = 1.5A, T_A = 50^{\circ}C/W, \\ \theta_{Heatsink\ Case} = 6^{\circ}C/W, \theta_{Heatsink\ Case} = 0.5^{\circ}C/W, \theta_{JC} = 3^{\circ}C/W$$

Power dissipation under this condition

$$P_D = (V_{IN} - V_{OUT}) * I_{OUT} = 7.5W$$

Junction Temperature

$$T_J = T_A + P_D * (\theta_{Case - HS} + \theta_{HS} \theta_{JC})$$

For the Control Section

$$T_J = 50 + 7.5 * (0.5 + 6 * 3) = 121.25^{\circ}C$$

$121.25^{\circ}C < T_{J(max)}$  for the Control & Power Sections.

In both case reliable operation is insured by adequate junction temperature.

### Capacitor Requirements

The output capacitor is needed for stability and to minimize the output noise. The required value of the capacitor varies with the load. However, a minimum value of 10 $\mu$ F Aluminum will guarantee stability over load. A tantalum capacitor is recommended for a fast load transient response

If the power source has high AC impedance, a 0.1 $\mu$ F capacitor between input & ground is recommended. This capacitor should have good characteristics up to 250 kHz.

### Minimum Load Current

To ensure a proper behavior of the regulator at light load, a minimum load of 10mA for SPX2730/31/32/33 is required.

### Adjustable Regulator Design

SPX2732/33 are adjustable regulators and maybe programmed for any value between 1.25V and 16V using two resistors. The relation between the resistors is given by:

$$R_1 = R_2 (V_{OUT}/1.240 - 1)$$

Resistors have a large value up to 1m $\Omega$  in order to reduce the current consumption. This might be interesting in the case of widely varying load currents.

### Error Flag

SPX2731/33 features an error indicating either an over current fault or a low input voltage. This flag pulls low when such a problem occurs and may sink 10mA. It is inoperative during thermal shutdown.

### Enable Input

SPX2731/32 features enable input allowing turning ON & OFF the device. EN has been designed to be compatible with TTL/CMOS logic. When the regulator is ON, the current flowing through this pin is approximately 20 $\mu$ A.

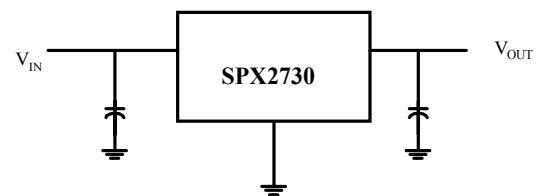

Fig.1 Basic Fixed Output Regulator

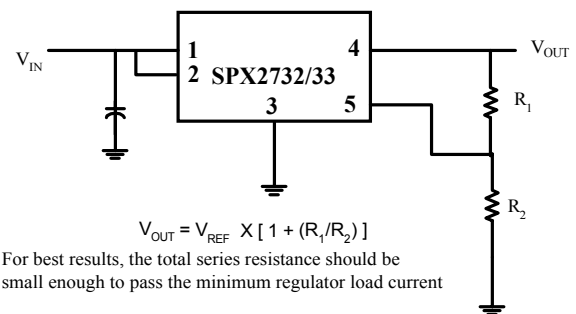
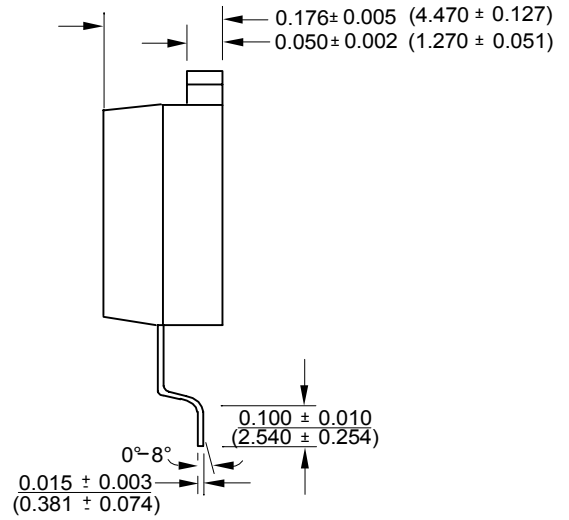
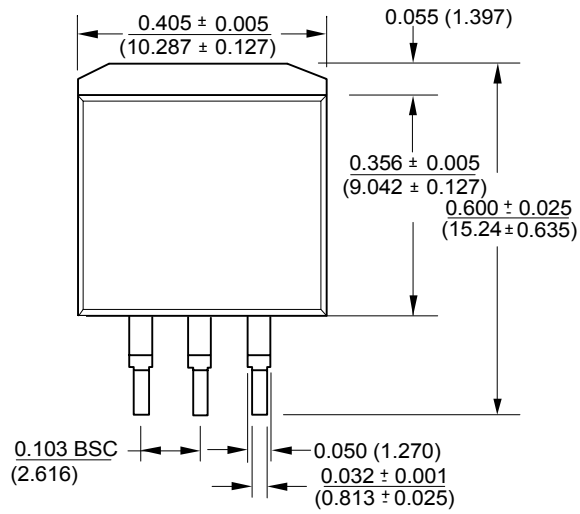
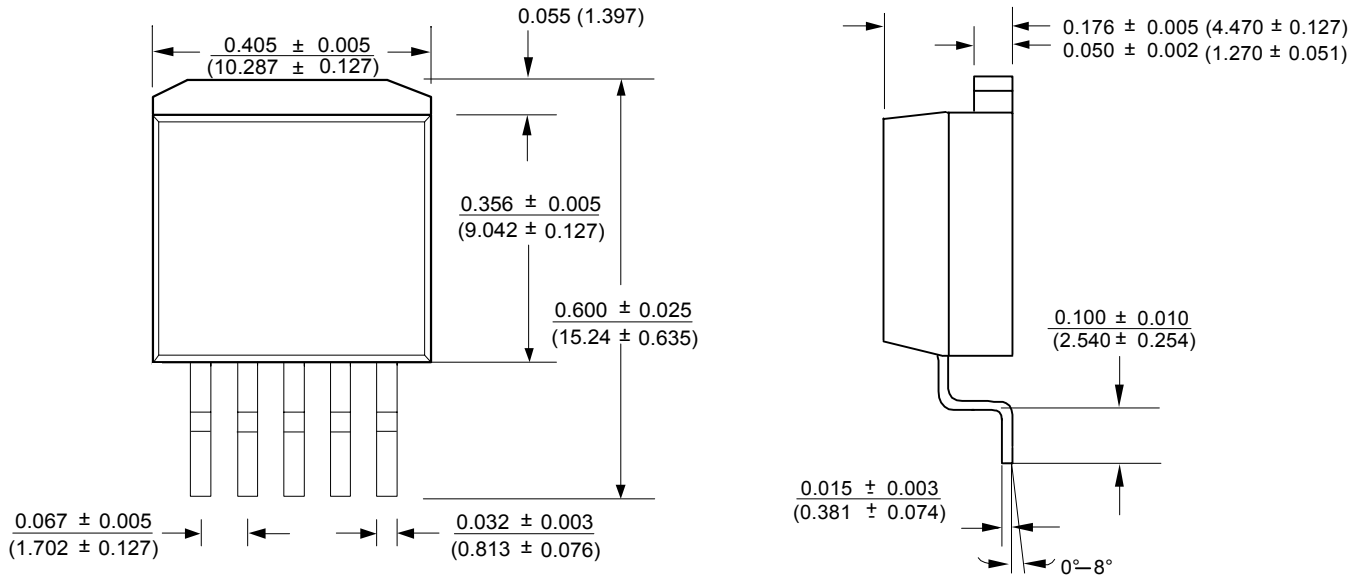

Fig. 2 Adjustable Output Voltage Regulator

## PACKAGE DRAWING TO-263-3L (T)



PACKAGE DRAWING  
TO-263-5L (T)



PACKAGE DRAWING  
TO-220-3L (U)

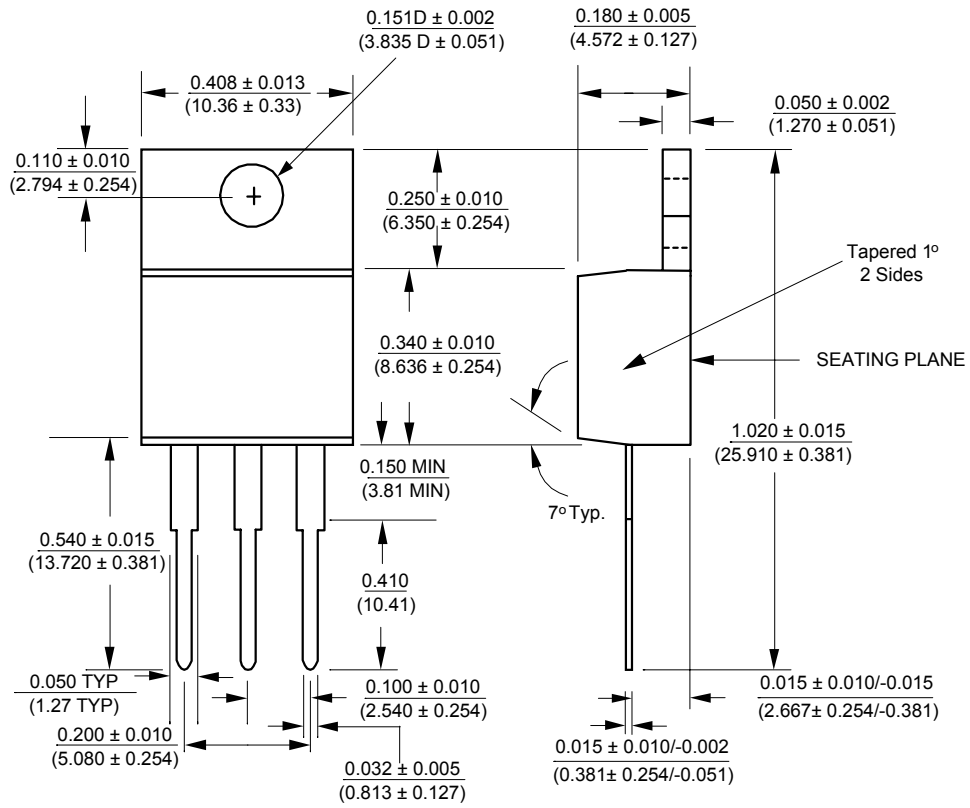

PACKAGE DRAWING  
TO-220-5L (U)

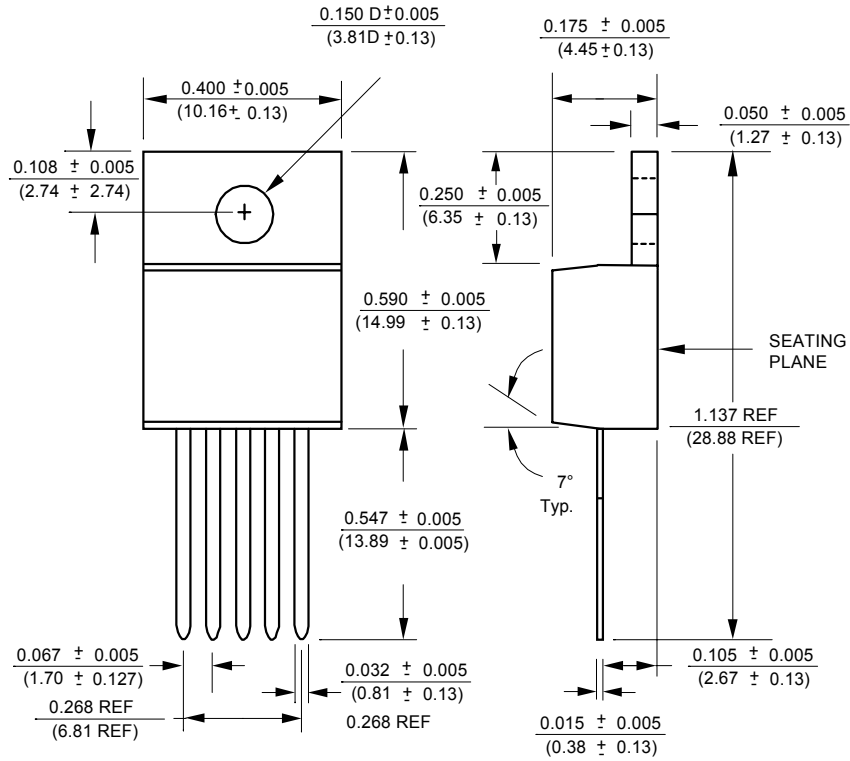



## ORDERING INFORMATION

Ordering No.	Output Voltages	Packages
SPX2730U-3.3	3.3V	3 Lead TO-220
SPX2730U-5.0	5.0V	3 Lead TO-220
SPX2730T-3.3	3.3V	3 Lead TO-263
SPX2730T-5.0	5.0V	3 Lead TO-263
SPX2731U-3.3	3.3V	3 Lead TO-220
SPX2731U-5.0	5.0V	3 Lead TO-220
SPX2731T-3.3	3.3V	3 Lead TO-263
SPX2731T-5.0	5.0V	3 Lead TO-263
SPX2732U	Adj	5 Lead TO-220
SPX2732U-3.3	3.3V	3 Lead TO-220
SPX2732U-5.0	5.0V	3 Lead TO-220
SPX2732T	Adj	5 Lead TO-263
SPX2732T-3.3	3.3V	3 Lead TO-263
SPX2732T-5.0	5.0V	3 Lead TO-263
SPX2733U	Adj	5 Lead TO-220
SPX2733U-3.3	3.3V	3 Lead TO-220
SPX2733U-5.0	5.0V	3 Lead TO-220
SPX2733T	Adj	5 Lead TO-263
SPX2733T-3.3	3.3V	3 Lead TO-263
SPX2733T-5.0	5.0V	3 Lead TO-263



SIGNAL PROCESSING EXCELLENCE

### Sipex Corporation

#### Headquarters and Main Offices:

22 Linnell Circle  
Billerica, MA 01821  
TEL: (978) 667-8700  
FAX: (978) 670-9001  
e-mail: sales@sipex.com

233 South Hillview Drive  
Milpitas, CA 95035  
TEL: (408) 935-7600  
FAX: (408) 934-7500

Sipex Corporation reserves the right to make changes to any products described herein. Sipex does not assume any liability arising out of the application or use of any product or circuit described herein; neither does it convey any license under its patent rights nor the rights of others.