

## Transient Voltage Suppressors Array for ESD Protection

Low Capacitance

### SR05-02A

#### Description

The SR05-02A is designed to protect voltage sensitive components from ESD and transient voltage events. Excellent clamping capability, low leakage, and fast response time, make these parts ideal for ESD protection on designs where board space is at a premium.

#### Feature

- ◆ 300 Watts Peak Pulse Power per Line (tp=8/20μs)
- ◆ Protects two I/O lines
- ◆ Low clamping voltage
- ◆ Working voltages : 5V
- ◆ Low leakage current
- ◆ IEC61000-4-2 (ESD) ±15kV (air), ±8kV (contact)
- ◆ IEC61000-4-4 (EFT) 40A (5/50ns)
- ◆ IEC61000-4-5 (Lightning) 3A (8/20μs)

#### Applications

- ◆ USB Power & Data Line Protection
- ◆ Ethernet 10BaseT
- ◆ I2C Bus Protection
- ◆ Video Line Protection
- ◆ T1/E1 secondary IC Side Protection
- ◆ Microcontroller Input Protection
- ◆ ISDN S/T Interface
- ◆ WAN/LAN Equipment

SOT-143

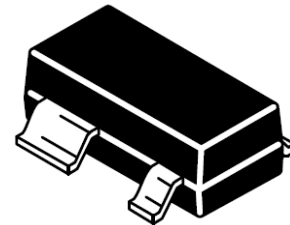

#### Functional Diagram

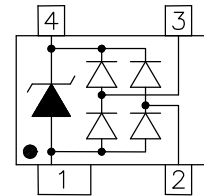

#### Mechanical Characteristics

- ◆ JEDEC SOT-143 Package
- ◆ Molding Compound Flammability Rating : UL 94V-0
- ◆ Weight 10.0 Milligrams (Approximate)
- ◆ Quantity Per Reel : 3,000pcs
- ◆ Reel Size : 7 inch
- ◆ Lead Finish : Lead Free

#### Mechanical Characteristics

Symbol	Parameter	Value	Units
P <sub>PP</sub>	Peak Pulse Power (tp=8/20μs waveform)	300	W
T <sub>L</sub>	Lead Soldering Temperature	260 (10sec)	°C
T <sub>STG</sub>	Storage Temperature Range	-55 to +150	°C
T <sub>J</sub>	Operating Temperature Range	-55 to +150	°C
	IEC61000-4-2 (ESD)	Air Discharge ±15 Contact Discharge ±8	KV
	IEC61000-4-4 (EFT)	40	A
	IEC61000-4-5 ( Lightning )	3	A

**Transient Voltage Suppressors Array for ESD Protection**

**Low Capacitance**

**SR05-02A**

Electrical Characteristics (@ 25°C Unless Otherwise Specified)

Part Number	Device Marking	V <sub>RWM</sub> (V) (Max.)	V <sub>B</sub> (V) (Min.)	I <sub>T</sub> (mA)	V <sub>C</sub> @1A (Max.)	V <sub>C</sub>		I <sub>R</sub> (μA) (Max.)	C (pF) (Typ.)
						(Max.)	(@A)		
SR05-02A	BSL3	5	6	1	9.8	23	3	1	1.2

**Characteristic Curves**

**Fig1. 8/20μs Pulse Waveform**

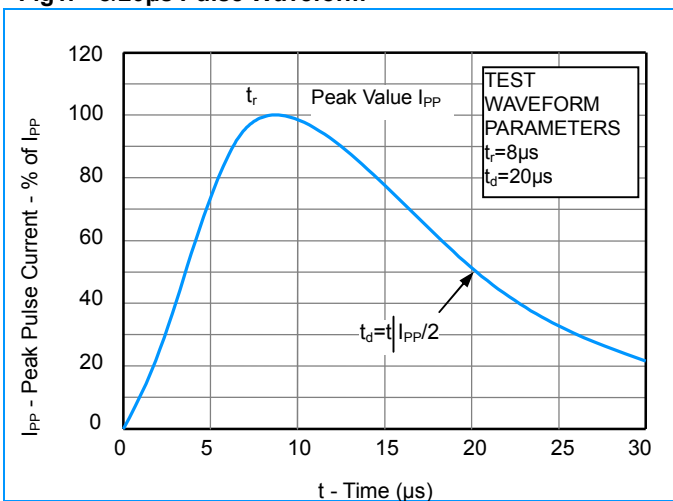

**Fig2. ESD Pulse Waveform (according to IEC 61000-4-2)**

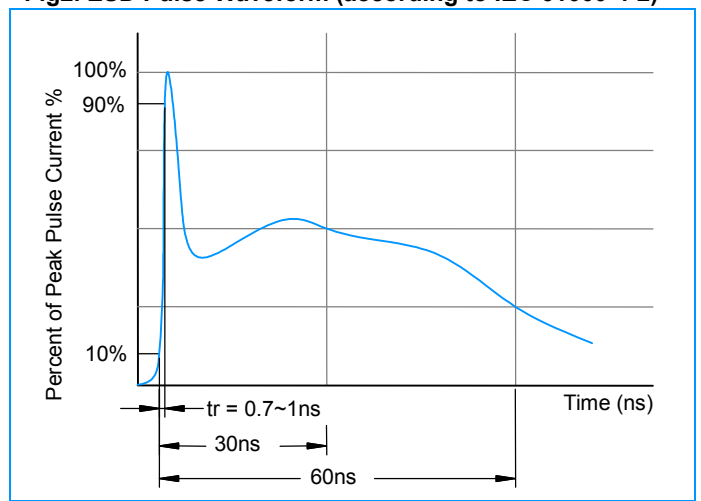

**Fig3. Power Derating Curve**

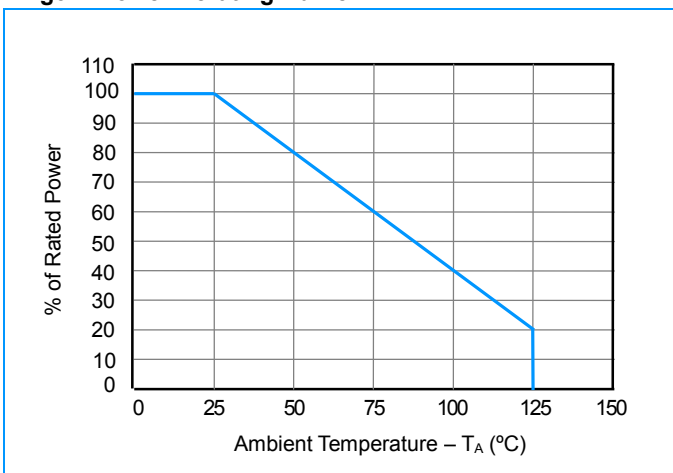

**Transient Voltage Suppressors Array for ESD Protection**

**Low Capacitance**

**SR05-02A**

**SOT-143 Package Outline & Dimensions**

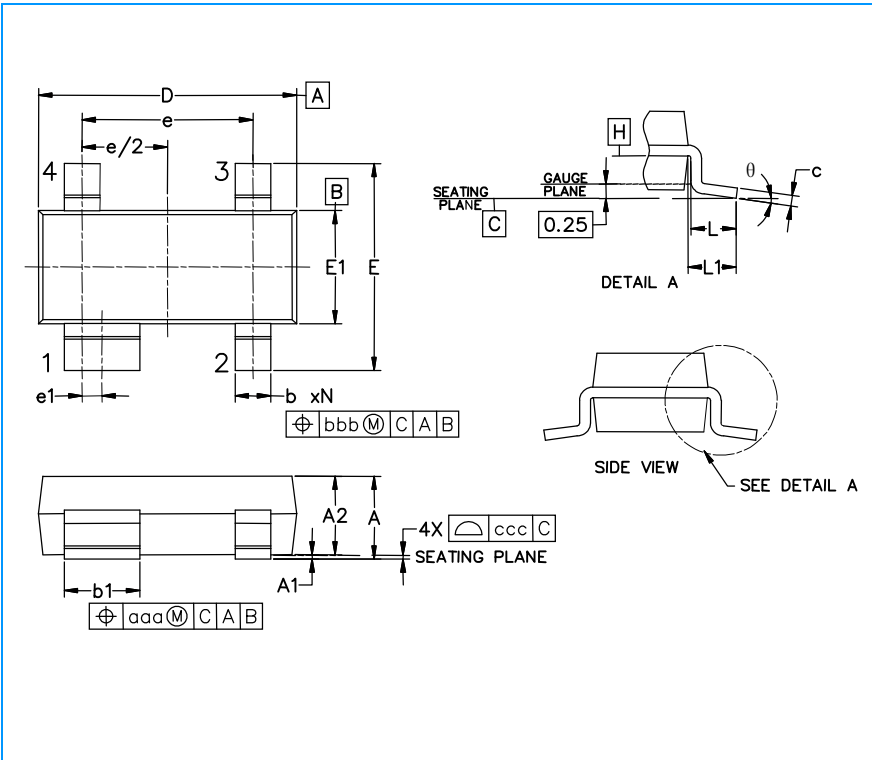

Symbol	Inches			Millimeters		
	Min.	Nom.	Max.	Min.	Nom.	Max.
A	0.031	-	0.048	0.80	-	1.22
A1	0.000	-	0.008	0.013	-	0.15
A2	0.020	0.035	0.042	0.75	0.90	1.07
b	0.011	-	0.020	0.30	-	0.51
b1	0.029	-	0.037	0.76	-	0.94
c	0.003	-	0.008	0.08	-	0.20
D	0.110	0.114	0.120	2.80	2.90	3.04
E	0.082	0.093	0.104	2.10	2.37	2.64
E1	0.047	0.051	0.055	1.20	1.30	1.40
e	0.075		1.92 BSC			
e1	0.008		0.20 BSC			
L	0.015	0.020	0.024	0.40	0.50	0.60
L1	(0.021)		(0.54)			
N	4		4			
θ	0°	-	8°	0°	-	8°
aaa	0.006		0.15			
bbb	0.008		0.20			
ccc	0.004		0.10			

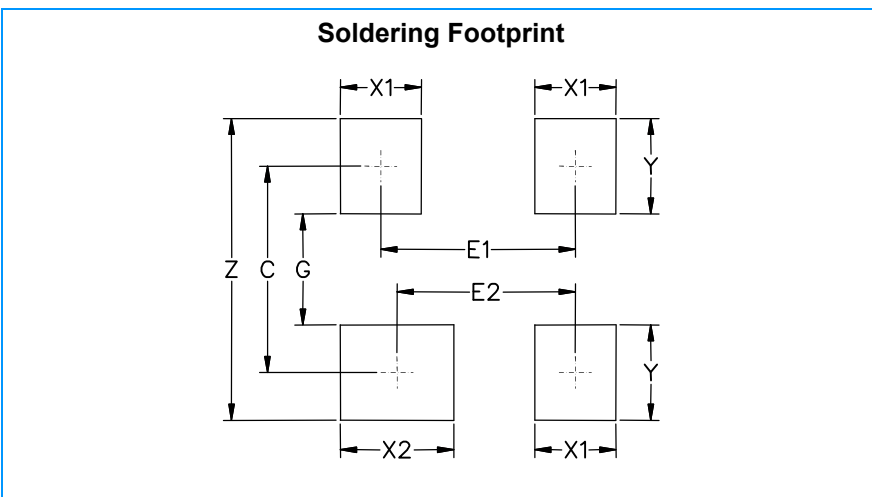

Symbol	Inches	Millimeters
C	(0.087)	(2.20)
E1	0.076	1.92
E2	0.068	1.72
G	0.031	0.80
X1	0.039	1.00
X2	0.047	1.20
Y	0.055	1.40
Z	0.141	3.60