

ULTRA LOW CAPACITANCE STEERING DIODE/TVS ARRAY

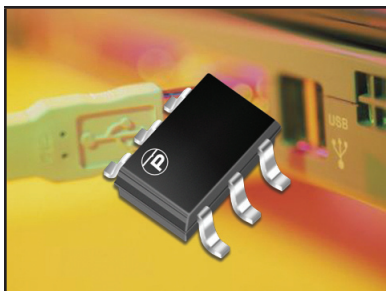

SOT-23-6 PACKAGE

DESCRIPTION

The SRV05-4LC is a high-powered, ultra low capacitance device for dual USB port and power bus protection. The SRV05-4LC is rated for 5.0V applications, with 500 Watts peak pulse power per line (8/20 μ s) and an ultra low capacitance of 0.7pF (C_{J(SD)}). The SRV05-4LC is ideally suited for surge suppression and ESD protection of high-speed data line applications such as video graphic cards, 3G cellular handsets, gigabit Ethernet and SIMM cards.

The SRV05-4LC combines eight ultra low capacitance steering diodes for up to four individual data or transmission lines and one TVS diode for the power bus. This device is offered in the space-saving SOT-23-6 package configuration. The small package size minimizes the lead inductance, preventing overshoot voltages during high ESD current events. ProTek recommends that the SRV05-4LC be mounted near the connector on the PCB. This device meets and exceeds the ESD requirements of IEC 61000-4-2 and the EFT requirements of IEC 61000-4-4.

FEATURES

- Compatible with IEC 61000-4-2 (ESD): Air 15kV, Contact 8kV
- Compatible with IEC 61000-4-4 (EFT): 40A, 5/50ns
- Compatible with IEC 61000-4-5 (Surge): 24A, 8/20 μ s - Level 2(Line-Gnd) & Level 3(Line-Line)
- 500 Watts Peak Pulse Power per Line(tp = 8/20 μ s)
- ESD Protection > 25 kilovolts
- Low Clamping Voltage
- Protection for 4 Lines
- Ultra Low Capacitance C_{J(SD)}: 0.7pF Typical
- RoHS Compliant
- REACH Compliant

APPLICATIONS

- Gigabit Ethernet
- SMART Phones
- Portable Electronics
- Video Card Interfaces
- USB 2.0 Interfaces
- DVI Interfaces

MECHANICAL CHARACTERISTICS

- Molded JEDEC SOT-23-6 Package
- Approximate Weight: 16 milligrams
- Lead-Free Nickel Paladium Gold Plating
- Solder Reflow Temperature:
Nickel-Paladium-Gold: Ni/Pd/Au, 96/3.5/0.5: 260-270°C
- Flammability Rating UL 94V-0
- 8mm Tape and Reel per EIA Standard 481

PIN CONFIGURATION

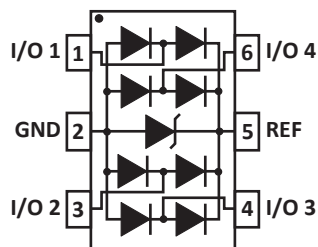

TYPICAL DEVICE CHARACTERISTICS
MAXIMUM RATINGS @ 25°C Unless Otherwise Specified

| PARAMETER | SYMBOL | VALUE | UNITS |
|--|------------------|---------------------|-------|
| Peak Pulse Power (tp = 8/20μs) - See Figure 1 | P _{PP} | 500 | Watts |
| Operating Temperature | T _L | -55 to 150 | °C |
| Storage Temperature | T _{STG} | -55 to 150 | °C |
| Forward Surge Rating (5ms @ 25°C, I _F = 10mA) | V _F | 0.5 Min. - 1.2 Max. | Volts |

ELECTRICAL CHARACTERISTICS PER LINE @ 25°C Unless Otherwise Specified

| PART NUMBER | DEVICE MARKING | RATED STAND-OFF VOLTAGE (Note 1) V _{WM} VOLTS | MINIMUM BREAKDOWN VOLTAGE (Note 1) @ 1mA V _(BR) VOLTS | MAXIMUM CLAMPING VOLTAGE (Fig. 2) (Note 1) @ I _p = 1A V _C VOLTS | MAXIMUM CLAMPING VOLTAGE (Fig. 2) (Note 1) @ I _p = 5A V _C VOLTS | MAXIMUM LEAKAGE CURRENT (Note 1) @V _{WM} I _D μA | TYPICAL CAPACITANCE (Note 2) @0V, 1MHz C _{J(SD)} pF |
|-------------|----------------|--|---|--|--|--|---|
| SRV05-4LC | TS | 5.0 | 6.0 | 12.0 | 15.0 | 5 | 0.7 |

NOTES

1. Measured from I/O pin to ground.
2. C_j = C(measured)/2.

TYPICAL DEVICE CHARACTERISTICS

FIGURE 1
PEAK PULSE POWER VS PULSE TIME

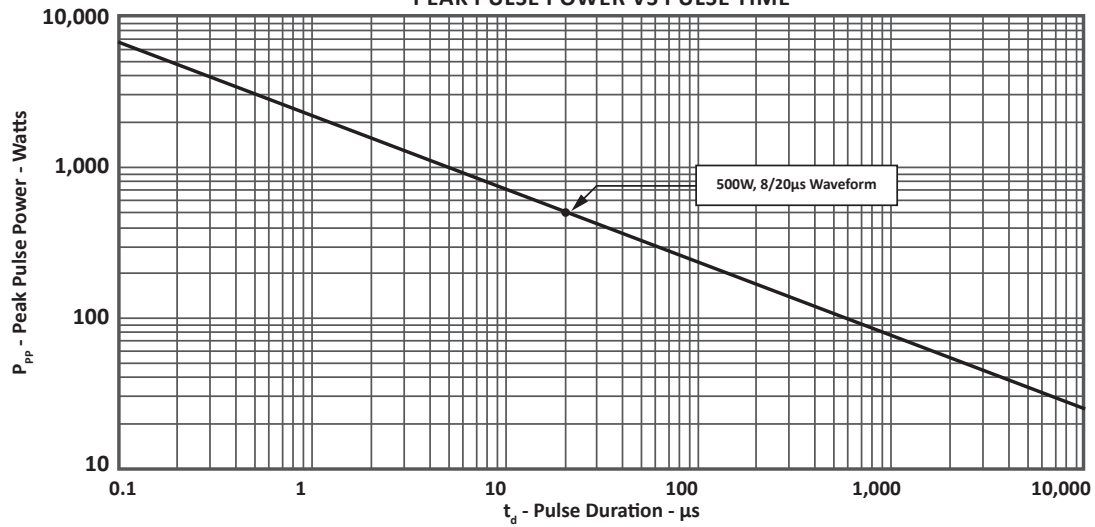
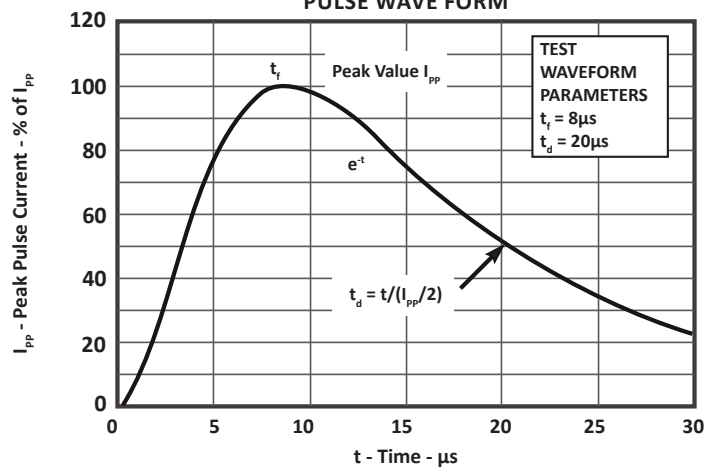
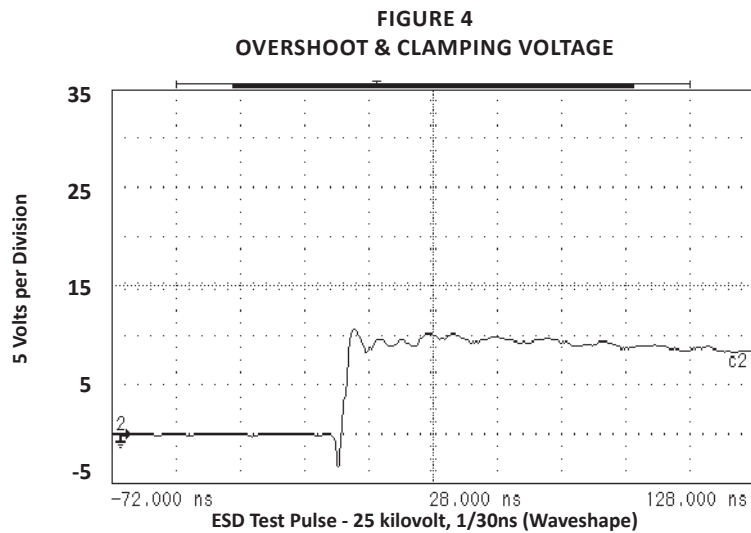
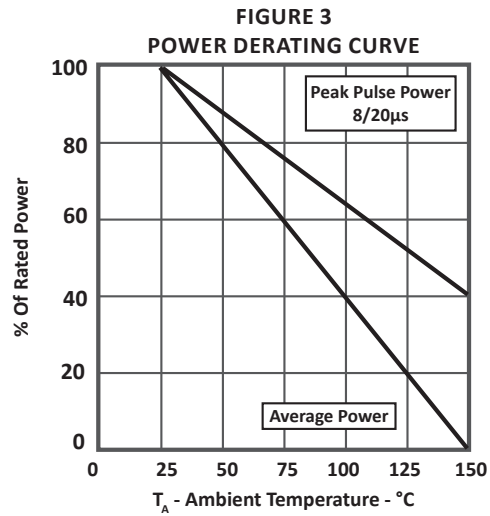

FIGURE 2
PULSE WAVE FORM



TYPICAL DEVICE CHARACTERISTICS



SOT-23-6 PACKAGE INFORMATION

OUTLINE DIMENSIONS

| DIM | MILLIMETERS | | INCHES | |
|-----|-------------|------|--------|-------|
| | MIN | MAX | MIN | MAX |
| A | 2.80 | 3.05 | 0.110 | 0.120 |
| B | 1.50 | 1.75 | 0.059 | 0.070 |
| C | 0.90 | 1.30 | 0.036 | 0.051 |
| D | 0.30 | 0.40 | 0.012 | 0.016 |
| E | 0.85 | 1.05 | 0.033 | 0.040 |
| G | 0.90 | 1.45 | 0.036 | 0.057 |
| J | 0.09 | 0.20 | 0.003 | 0.008 |
| K | 2.60 | 3.00 | 0.102 | 0.118 |
| L | 0.0 | 0.15 | 0.0 | 0.006 |
| M | 0.30 | 0.60 | 0.012 | 0.024 |

NOTES

- Controlling dimension: inches.
- Dimensioning and tolerances per ANSI Y14.5M, 1985.
- Dimensions are exclusive of mold flash and metal burrs.

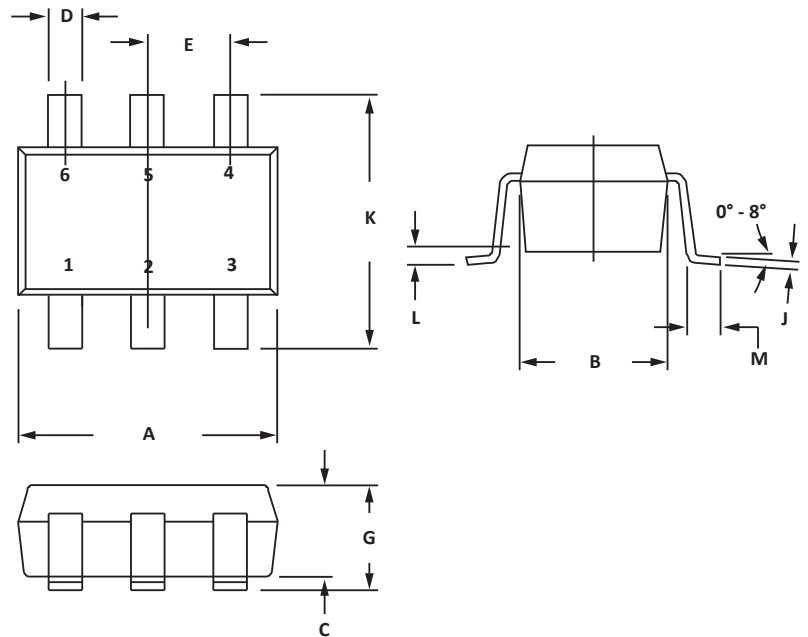

PAD LAYOUT DIMENSIONS

| DIM | MILLIMETERS | INCHES |
|-----|-------------|---------|
| | NOMINAL | NOMINAL |
| A | 0.70 | 0.028 |
| B | 1.90 | 0.074 |
| C | 0.95 | 0.037 |
| D | 2.40 | 0.094 |
| E | 1.00 | 0.039 |

NOTES

- Controlling dimension: inches.

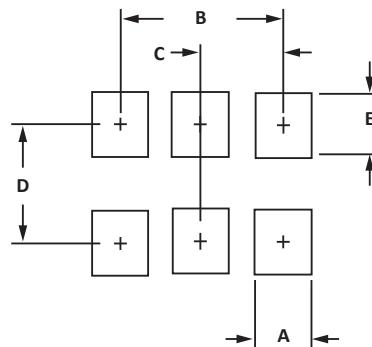

TAPE AND REEL

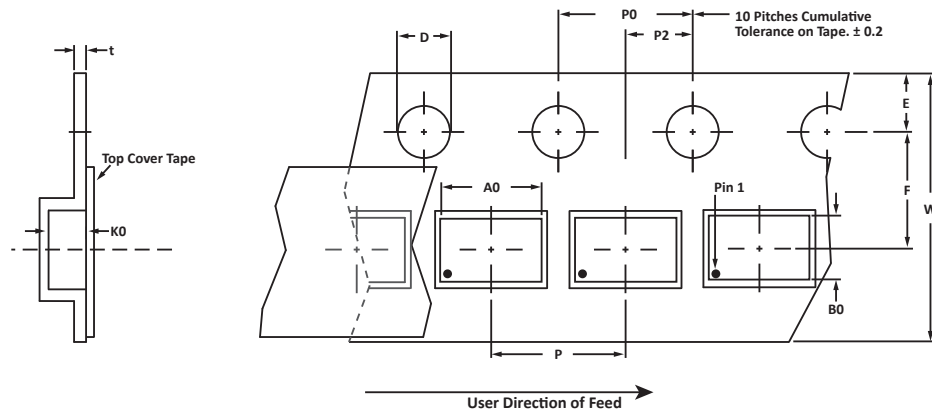

SPECIFICATIONS

| REEL DIA. | TAPE WIDTH | A0 | B0 | K0 | D | E | F | W | P0 | P2 | P | tmax |
|------------|------------|-------------|-------------|-------------|-------------|-------------|-------------|-------------|-------------|-------------|-------------|------|
| 178mm (7") | 8mm | 3.20 ± 0.10 | 3.20 ± 0.10 | 1.65 ± 0.10 | 1.50 ± 0.10 | 1.75 ± 0.10 | 3.50 ± 0.05 | 8.00 ± 0.30 | 4.00 ± 0.10 | 2.00 ± 0.05 | 4.00 ± 0.10 | 0.25 |

NOTES

1. Dimensions are in millimeters.
2. Surface mount product is taped and reeled in accordance with EIA-481.
3. Suffix - T7 = 7" Reel - 3,000 pieces per 8mm tape.
4. Marking on Part - marking code (see page 2) and pin one defined by dot on package.

Package outline, pad layout and tape specifications per document number 06013.R5 2/11

ORDERING INFORMATION

| BASE PART NUMBER | LEADFREE SUFFIX | TAPE SUFFIX | QTY/REEL | REEL SIZE | TUBE QTY |
|------------------|-----------------|-------------|----------|-----------|----------|
| SRV05-4LC | n/a | -T7 | 3,000 | 7" | n/a |

COMPANY INFORMATION

COMPANY PROFILE

ProTek Devices, based in Tempe, Arizona USA, is a manufacturer of Transient Voltage Suppression (TVS) products designed specifically for the protection of electronic systems from the effects of lightning, Electrostatic Discharge (ESD), Nuclear Electromagnetic Pulse (NEMP), inductive switching and EMI/RFI. With over 25 years of engineering and manufacturing experience, ProTek designs TVS devices that provide application specific protection solutions for all electronic equipment/systems.

ProTek Devices Analog Products Division, also manufactures analog interface, control, RF and power management products.

CONTACT US

Corporate Headquarters

2929 South Fair Lane
Tempe, Arizona 85282
USA

By Telephone

General: 602-431-8101
Sales: 602-414-5109
Customer Service: 602-414-5114

By Fax

General: 602-431-2288

By E-mail:

Sales: sales@protekdevices.com
Customer Service: service@protekdevices.com
Technical Support: support@protekdevices.com

Web

www.protekdevices.com
www.protekanalog.com

COPYRIGHT © ProTek Devices 2008 - This literature is subject to all applicable copyright laws and is not for resale in any manner.

SPECIFICATIONS: ProTek reserves the right to change the electrical and or mechanical characteristics described herein without notice.

DESIGN CHANGES: ProTek reserves the right to discontinue product lines without notice and that the final judgement concerning selection and specifications is the buyer's and that in furnishing engineering and technical assistance. ProTek assumes no responsibility with respect to the selection or specifications of such products. ProTek makes no warranty, representation or guarantee regarding the suitability of its products for any particular purpose, nor does ProTek assume any liability arising out of the application or use of any product or circuit and specifically disclaims any and all liability without limitation special, consequential or incidental damages.

LIFE SUPPORT POLICY: ProTek Devices products are not authorized for use in life support systems without written consent from the factory.