

Description

- High speed switching application.
- Analog switch application.

Features

- 2.5V Gate drive.
- Low threshold voltage : $V_{th} = 0.5 \sim 1.5V$.
- High speed.

Ordering Information

Type NO.	Marking	Package Code
STK1828M	1828	TO-92M

Outline Dimensions

unit : mm

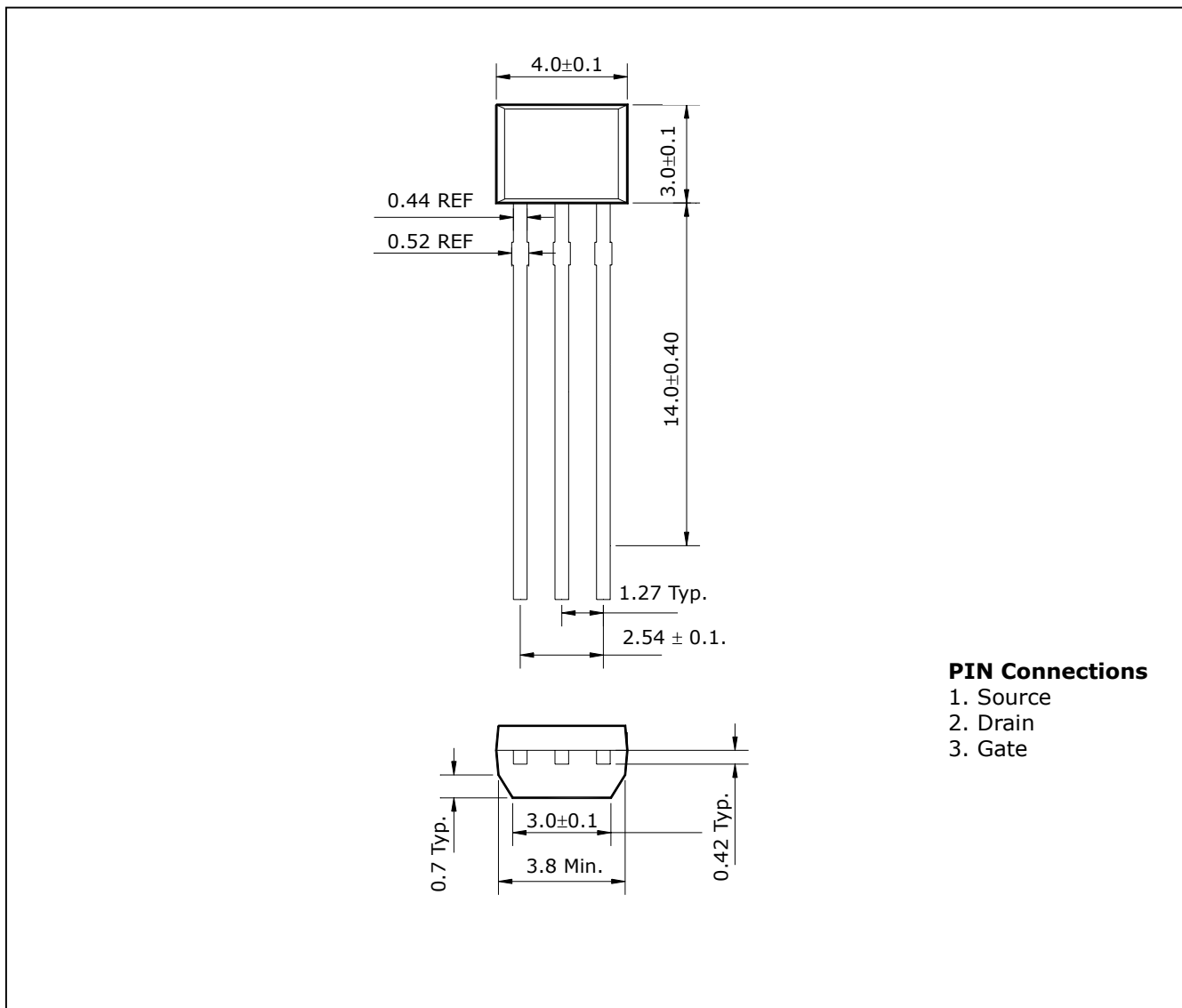

PIN Connections

1. Source
2. Drain
3. Gate

Absolute maximum ratings

(Ta=25°C)

Characteristic	Symbol	Ratings	Unit
Drain-Source voltage	V_{DS}	20	V
Gate-Source voltage	V_{GSS}	10	V
DC Drain current	I_D	50	mA
Drain Power dissipation	P_D	400	mW
Channel temperature	T_{ch}	150	°C
Storage temperature range	T_{stg}	-55~150	°C

Electrical Characteristics

(Ta=25°C)

Characteristic	Symbol	Test Condition	Min.	Typ.	Max.	Unit
Drain-Source breakdown voltage	BV_{DSS}	$I_D=100\mu A, V_{GS}=0$	20			V
Gate-Threshold voltage	V_{th}	$I_D=0.1mA, V_{DS}=3V$	0.5		1.5	V
Drain cut-off current	I_{DSS}	$V_{DS}=20V, V_{GS}=0$			1	μA
Gate leakage current	I_{GSS}	$V_{GS}=10V, V_{DS}=0$			1	μA
Drain-Source on-resistance	$R_{DS(ON)}$	$V_{GS}=2.5V, I_D=10mA$		10	20	Ω
Forward transfer admittance	$ Y_{fs} $	$V_{DS}=3V, I_D=10mA$	20			mS
Input capacitance	C_{iss}	$V_{DS}=3V, V_{GS}=0, f=1MHz$		5.5		pF
Output capacitance	C_{oss}	$V_{DS}=3V, V_{GS}=0, f=1MHz$		6.5		pF
Reverse Transfer capacitance	C_{rss}	$V_{DS}=3V, V_{GS}=0, f=1MHz$		1.6		pF
Turn-on time	t_{ON}	$V_{DD}=3V, I_D=10mA$ $V_{GEN}=0\sim 2.5V$		0.14		μs
Turn-off time	t_{OFF}	$V_{DD}=3V, I_D=10mA$ $V_{GEN}=0\sim 2.5V$		0.14		μs

Electrical Characteristic Curves

Fig.1 $I_D - V_{DS}$

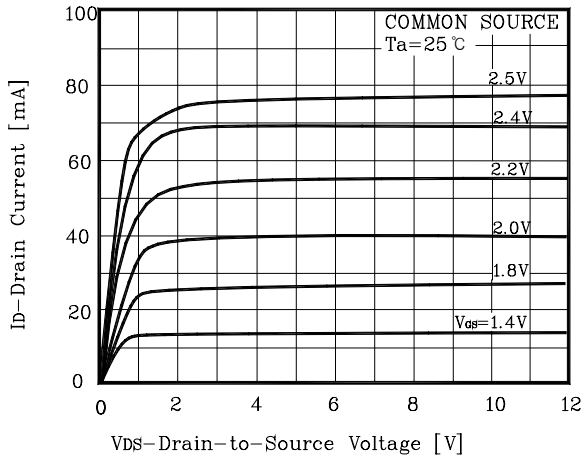

Fig.2 $P_D - T_a$

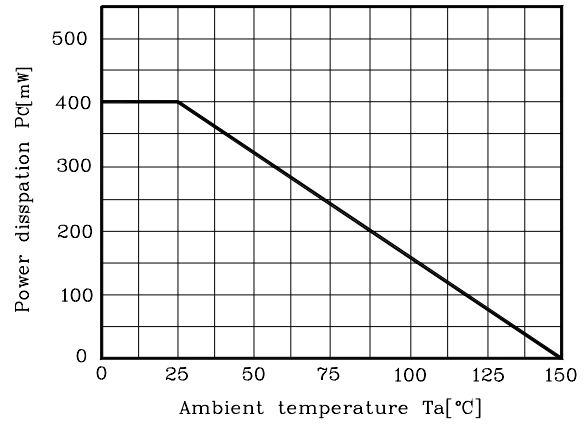

Fig.3 $I_{DR} - V_{DS}$

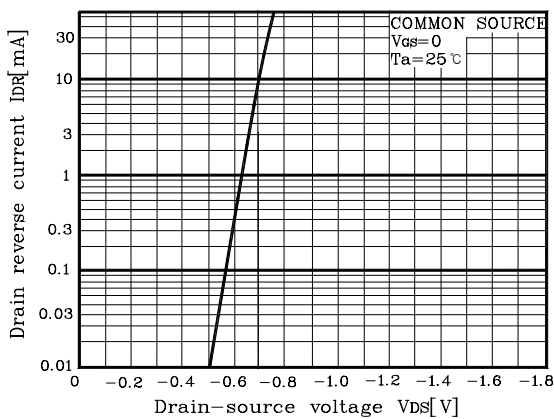

Fig.4 $I_D - V_{GS}$

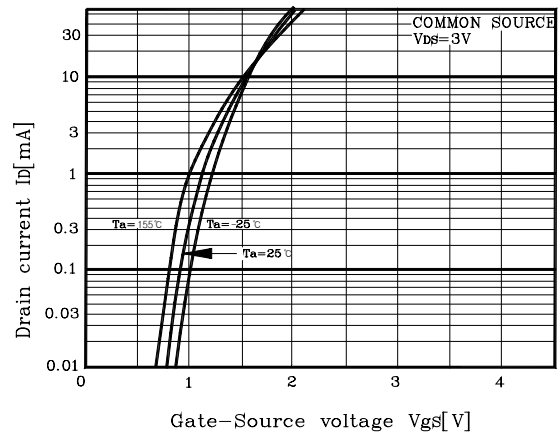

Fig.5 $|Y_{fs}| - I_D$

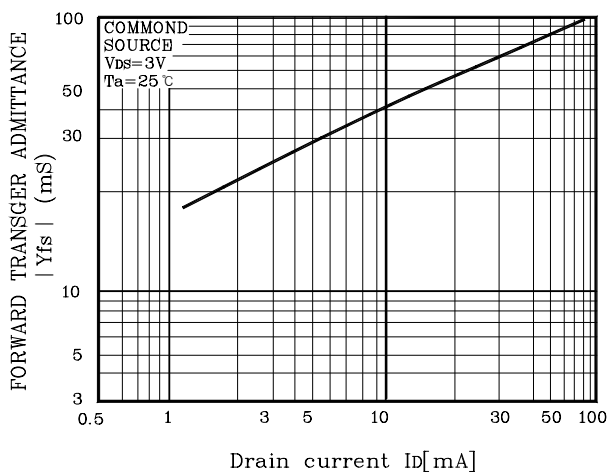
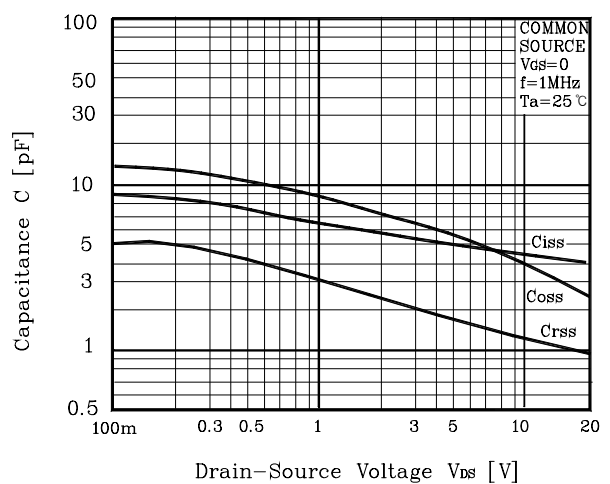

Fig.6 $C - V_{DS}$



Electrical Characteristic Curves

Fig.7 $V_{DS} - I_D$

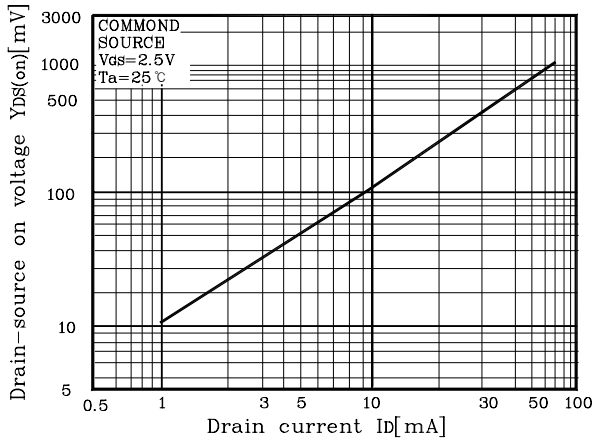

Fig.8 $t - I_D$

