

SEMICONDUCTORS

MCM has an extensive selection of SMD (Surface Mount Devices) which are denoted on the following page with an *(asterisk)!

COUNT ON MCM TO ALWAYS PROVIDE...

- High quality semiconductors
- Original parts-never rebrands
- Broad selection
- Competitive pricing
- Hard to find items
- Customer support
- One year warranty
- Parts listed in computer sort order

If MCM is not able to supply an item, a guaranteed substitute may be sent.

Semiconductors/Components

Audio Power Amplifiers	348	Multicomp	360, 364
Audio Grade Capacitors	361	Nichicon	354-359, 361, 362
Bridge Rectifiers	348, 349	NTE	351-355, 364-367
Capacitors	354-363	ON	347
Crystals	366	Panasonic	356-359, 362
Diodes	348, 349, 351, 353	Potentiometers	366, 367
Electron Tubes	361	Reference Books/CDs	348, 349, 351, 355, 359, 366
Heat Sinks	350	Resistors	363-366
IC Protectors	350	Thermal Fuses	365
IC Sockets	350	United Chemicon	356-358, 362
Kemet	355, 360, 361	Vishay	355, 362
Kits	349, 351, 354, 355, 366		
Meggitt	364		



New semiconductors are printed in purple.

Order #	(1-9)	Order #	(1-9)	Order #	(1-9)	Order #	(1-9)	Order #	(1-9)	Order #	(1-9)	Order #	(1-9)	Order #	(1-9)		
A3141LUA	\$1.64	AD594AD	\$26.40	AD797BR	\$10.72	AN274	\$7.79	AN5156K	\$7.25	AN5416	\$11.95	AN6209	\$8.19	AN6553	\$3.62	AN7145	\$7.89
A3212ELHLT	0.77	AD595AQ	13.90	AD8001AR	4.76	AN278	4.10	AN5160	14.20	AN5435	3.39	AN6291	7.79	AN6554	0.46	AN7146	6.89
A3280LLHLT	1.07	AD595CD	40.29	AD811JR	6.31	AN287	3.44	AN5160NK	14.20	AN5436	1.84	AN6306	8.89	AN6555	0.98	AN7147	1.58
A3515EUA	1.81	AD595CQ	25.13	AD8138AR	5.52	AN304	7.99	AN5163	8.56	AN5436N	1.84	AN6307	4.39	AN6612	0.89	AN7148	3.93
A3515LUA	1.92	AD603AR	8.96	AD823AR	4.80	AN315	8.39	AN5163K	8.56	AN5512	2.42	AN6310	7.59	AN6876	3.69	AN7149	3.93
A3516LUA	1.92	AD606JR	45.20	AD8554AR	6.34	AN3310	11.95	AN5165K	16.18	AN5515	3.36	AN6342	5.99	AN6912	1.46	AN7149N	3.93
A6275EA	1.44	AD620BN	8.50	AD9240AS	28.53	AN3310K	11.95	AN5262	4.89	AN5520	7.49	AN6344	14.95	AN6914	3.69	AN7158	9.59
A6276EA	2.13	AD620BR	8.50	AD976AR	36.24	AN3312	7.59	AN5265	0.79	AN5521	2.28	AN6346	12.42	AN7062	2.29	AN7161	4.32
A6810SA	1.88	AD625CD	58.01	AMP01GS	16.76	AN3313	7.59	AN5277	2.79	AN5522	3.99	AN6359	16.95	AN7062N	2.29	AN7161N	4.32
AC128	1.74	AD630JN	18.56	AN103	8.09	AN360	2.90	AN5301	14.95	AN5532	9.35	AN6360	7.79	AN7110	0.77	AN7161NFP	5.99
AC141	6.29	AD633JN	6.80	AN1393	3.69	AN362	7.49	AN5302	3.61	AN5539	2.29	AN6361	7.59	AN7115	5.29	AN7166	9.59
AD202JY	47.25	AD637KQ	35.05	AN1431	1.54	AN363	7.29	AN5302K	3.61	AN5551	1.39	AN6366	12.95	AN7124	1.72	AN7168	7.69
AD210AN	78.25	AD652AQ	16.58	AN1431T	0.59	AN366	5.59	AN5304NK	9.60	AN5700	2.47	AN6366NK	12.95	AN7125	3.62	AN7169	7.69
AD210BN	93.45	AD652BQ	26.25	AN1741	1.02	AN377	6.69	AN5306NFB*		AN5753	1.40	AN6387	12.95	AN7131	1.46	AN7173	4.77
AD210JN	69.30	AD654JN	3.67	AN17805A	3.59	AN4558	0.56		28.59	AN5763	1.79	AN6531	5.78	AN7134NR	4.63	AN7173K	4.77
AD215BY	79.70	AD694JN	12.36	AN211	6.79	AN5020	3.87	AN5310	23.95	AN5790	1.53	AN6551	1.59	AN7135	2.07	AN7178	2.16
AD524AD	20.51	AD699AP	28.65	AN214	8.19	AN5070	3.67	AN5320	6.79	AN5836	1.05	AN6552	0.56	AN7140	1.46	AN7178NK	2.16
AD569JN	45.60	AD7545AKN	12.39	AN217	6.29	AN5125	8.89	AN5330	14.95	AN5862	3.57						
AD581JH	6.42	AD7715AN-5	9.78	AN221	4.89	AN5135	14.95	AN5352	7.09	AN5862K	3.57						
AD590JF	16.22	AD7722AS	46.64	AN240	4.89	AN5136	3.79	AN5352N	7.09	AN612	6.29						
AD590LH	26.53	AD780BR	11.77	AN241	4.99	AN5136K	3.79	AN5410	8.79	AN614	19.83						
AD590MF	95.68	AD7846KN	49.72	AN262	6.89	AN5156	7.25										



Table with 3 columns: Order # (1-9), Order # (1-9), Order # (1-9). Lists various semiconductor components and their prices.

Table with 2 columns: Order # (1-9), Order # (1-9). Lists semiconductor components and prices.

New semiconductors are printed in purple.

Table with 2 columns: Order # (1-9), Order # (1-9). Lists semiconductor components and prices.

Table with 2 columns: Order # (1-9), Order # (1-9). Lists semiconductor components and prices.

Table with 2 columns: Order # (1-9), Order # (1-9). Lists semiconductor components and prices.

Table with 2 columns: Order # (1-9), Order # (1-9). Lists semiconductor components and prices.

Table with 2 columns: Order # (1-9), Order # (1-9). Lists semiconductor components and prices.



Order #	(1-9)	Order #	(1-9)	Order #	(1-9)	Order #	(1-9)	Order #	(1-9)	Order #	(1-9)	Order #	(1-9)	Order #	(1-9)	Order #	(1-9)
KIA7805API	\$0.40	LA4495	\$14.03	LA7822	\$1.63	LM1823N	\$11.95	LM393N	\$2.59	M51387P	\$15.13	MC14069	\$0.61	MJE243	\$4.70	MR2520L	\$3.99
KIA7809	1.62	LA4500	3.75	LA7831	4.59	LM1875T	2.73	LM4558	0.85	M51411SP	9.08	MC14070BCP	0.48	MJE2801	27.95	MR501	0.26
KIA7812API	0.99	LA4505	2.69	LA7832	2.29	LM1876	6.51	LM4559	3.59	M51414BSP	10.34	MC14071BCP	0.67	MJE2955T	1.20	MR751	1.00
KIA7912PI	1.09	LA4550	2.38	LA7833	3.39	LM1876T	6.51	LM4701T.	2.78	M5186	8.99	MC14077	0.71	MJE3055	2.90	MR751	1.00
KIA8210H	5.98	LA4558	2.48	LA7835	4.00	LM1877	5.11	LM4752TS.	2.42	M5186P	8.99	MC14077BCP	1.04	MJE3055T	3.48	MR821	1.43
KSA916	0.32	LA4597	1.22	LA7836	3.00	LM1877M-9.*		LM4755T.	2.36	M51977P	4.40	MC145106	9.99	MJE340	0.87	MR851	0.92
KSC1008	2.73	LA4598	3.02	LA7837	2.45			LM4765T	10.59	M51995AP	2.08	MC14514	2.00	MJE340K	0.87	MR856	0.87
KSC1096	0.95	LA4600	1.16	LA7838	1.69	LM1877N-9.	1.43	LM4835MTE*		M51995P	2.08	MC14514	2.00	MJE350	2.10	MRF475	10.40
KSC1507	1.05	LA4620	3.45	LA7840	2.46	LM1877N-9.	1.55	LM4835MTE*	4.05	M52023SP	9.83	MC14514	2.00	MJE720	2.33	MSP430F412IPM	5.20
KSC1674	0.35	LA4628	3.63	LA7841	1.99	LM2111	6.99	LM4836LQ.	3.43	M5216L	0.94	MC14081B	0.59	MJE800	0.48	MTA3J0N06E	6.93
KSC1730	0.14	LA4663	4.69	LA7845	4.85	LM224N	2.36	LM4860M.*	1.84	M5218	0.34	MC1408PB	4.96	MJF18004	6.89	MTP3055	4.58
KSC2330	0.47	LA4700	3.43	LA7845N	4.85	LM234H	7.10	LM4861M.*	1.84	M5218AL	1.55	MC14093	0.78	MM74C221N	2.03	MTP3055A	4.58
KSC2331	0.80	LA4700N	3.43	LA7846N	1.99	LM2407T	5.17	LM4862M.*	1.73	M5218AL	1.55	MC14490P	5.05	MM74HC123AM*	0.14	MTP50N06	2.90
KSC815	0.06	LA4705	2.61	LA7847	3.29	LM2876	5.95	LM4862N	7.19	M5218P	0.34	MC145106	9.99	MM74HC132N	0.92	MUR460	2.30
KSC900	0.16	LA4708	4.08	LA7848	4.99	LM2876T	4.30	LM4863MTE.*		M5220L	0.78	MC14514	2.00	MM74HC138N	0.62	MUR820	1.50
KSC945	0.08	LA4742	17.95	LA7850	4.76	LM2876TF.	5.95	LM4864MM.*	2.68	M5220L	0.78	MC14538BCP1.42	1.42	MM74HC165N	0.65	MX0541B-F	13.25
KSP42	0.39	LA4743B	8.99	LA7851	4.49	LM2896	12.95	LM4863N	7.19	M5223L	0.43	MC14541	1.01	MM74HC244N	0.52	MX0841-AB-F	11.17
KSP44	0.33	LA4743K	17.95	LA7852	3.99	LM2901	2.04	LM4864MM.*	1.39	M52300BSP	9.99	MC14558P	3.62	MMB2T3904	0.08	MX0841B-F	31.79
KTA1266	1.03	LA47503	23.95	LA7853	2.14	LM2903	1.90	LM4864MM.*	1.39	M52303ASP	6.89	MC14588	0.88	MN1280	0.61	MX0842	12.99
L200CH	4.19	LA47505	39.95	LA7856	3.30	LM2917	1.55	LM4864MM.*	2.36	M52303SP	6.89	MC14588	0.88	MN12C201D	3.37	MX0842AB	12.99
L295	4.66	LA47515	11.11	LA7856	3.30	LM2940T-5.0	0.09	LM4864N	7.19	M5230L	1.05	MC14588	0.88	MN2488	4.39	N80C188XL20	10.95
L297	4.85	LA4905	11.29	LA7875N	3.89	LM301	2.99	LM4865M.*	1.80	M52339SP	4.20	MC14588	0.88	MN3007	3.86	NE5532	1.39
L298	11.81	LA5525	3.73	LA7876N	6.89	LM301AN	1.60	LM48671LD.	1.39	M52342SP	4.29	MC14588	0.88	MN3101	6.78	NE5532N	1.39
L298N	11.81	LA5531	0.14	LA7911	0.89	LM3046	0.85	LM4871M.*	1.24	M52346SP	1.29	MC14588	0.88	MN3102	3.82	NE5534	2.42
L4960	8.14	LA6324	2.36	LA7916	1.66	LM3065	4.89	LM4880M.*	1.40	M5236	1.62	MC14588	0.88	MN3207	31.44	NE5534N	2.91
L6203	16.62	LA6358	1.72	LA7940	8.09	LM308	4.94	LM4880N	7.19	M5236L	1.62	MC14588	0.88	MN3307	3.86	NE555	0.60
L7805CV	0.87	LA6358	1.72	LA7952	0.76	LM3080	10.95	LM4890M.*	1.63	M5237L	0.39	MC14588	0.88	MN3307	3.86	NE556	1.44
L7809	1.67	LA6393D	0.88	LA7953	1.38	LM3089	6.69	LM4894MM.*	2.36	M5238AL	0.70	MC14588	0.88	MN3307	3.86	NE567	2.91
L7812	4.06	LA6458S	0.53	LA7956	0.78	LM308N	7.95	LM4894MM.*	2.36	M5238AL	0.70	MC14588	0.88	MN3307	3.86	NE567N	2.91
L7812-220	0.43	LA6500	4.94	LA9210M*	4.89	LM309	7.10	LM4894MM.*	2.36	M5238AL	0.70	MC14588	0.88	MN3307	3.86	NE567N	2.91
L7812CV	0.43	LA6508	7.69	LB11885N*	3.89	LM311H	2.60	LM4894MM.*	2.36	M5238P	0.70	MC14588	0.88	MN3307	3.86	NE567N	2.91
L7815	1.52	LA6510	1.02	LB1205	4.22	LM311M*	0.43	LM4894MM.*	2.36	M5238P	0.70	MC14588	0.88	MN3307	3.86	NE567N	2.91
L7815CV	1.58	LA6515	1.02	LB1234	4.22	LM311N	1.17	LM4894MM.*	2.36	M5238P	0.70	MC14588	0.88	MN3307	3.86	NE567N	2.91
LA1140	0.51	LA6520	1.65	LB1274	3.47	LM317	2.63	LM4894MM.*	2.36	M5238P	0.70	MC14588	0.88	MN3307	3.86	NE567N	2.91
LA1185	2.35	LA6531	2.03	LB1288	3.04	LM317T	2.63	LM4894MM.*	2.36	M5238P	0.70	MC14588	0.88	MN3307	3.86	NE567N	2.91
LA1186	0.55	LA6532M*	1.94	LB1292	4.27	LM318	2.69	LM4894MM.*	2.36	M5238P	0.70	MC14588	0.88	MN3307	3.86	NE567N	2.91
LA1205	0.44	LA6541D	3.75	LB1292	4.27	LM319H	7.49	LM4894MM.*	2.36	M5238P	0.70	MC14588	0.88	MN3307	3.86	NE567N	2.91
LA1231	1.68	LA7010M*	10.95	LB1405	4.32	LM319N	1.37	LM4894MM.*	2.36	M5238P	0.70	MC14588	0.88	MN3307	3.86	NE567N	2.91
LA1231N	1.68	LA7016	0.39	LB1409	7.09	LM320T-15	0.62	LM4894MM.*	2.36	M5238P	0.70	MC14588	0.88	MN3307	3.86	NE567N	2.91
LA1235	1.95	LA7040	5.59	LB1416	4.89	LM320T-24	4.70	LM4894MM.*	2.36	M5238P	0.70	MC14588	0.88	MN3307	3.86	NE567N	2.91
LA1245	3.13	LA71207M*	15.95	LB1639	0.69	LM323K	7.55	LM4894MM.*	2.36	M5238P	0.70	MC14588	0.88	MN3307	3.86	NE567N	2.91
LA1260	1.00	LA7161NM*	3.39	LB1640	3.37	LM324	0.55	LM4894MM.*	2.36	M5238P	0.70	MC14588	0.88	MN3307	3.86	NE567N	2.91
LA1265	1.41	LA71730EM*		LB1641	3.37	LM324N	0.55	LM4894MM.*	2.36	M5238P	0.70	MC14588	0.88	MN3307	3.86	NE567N	2.91
LA1265S	1.41	LA71750EM*		LB1643	0.75	LM334Z	1.59	LM4894MM.*	2.36	M5238P	0.70	MC14588	0.88	MN3307	3.86	NE567N	2.91
LA1266	4.12	LA7220	1.30	LB1645	1.29	LM335M*	1.90	LM4894MM.*	2.36	M5238P	0.70	MC14588	0.88	MN3307	3.86	NE567N	2.91
LA1353	8.49	LA7222	0.79	LB1648	1.40	LM337	1.35	LM4894MM.*	2.36	M5238P	0.70	MC14588	0.88	MN3307	3.86	NE567N	2.91
LA1354	5.79	LA7317	7.19	LB1649	1.58	LM338K	9.89	LM4894MM.*	2.36	M5238P	0.70	MC14588	0.88	MN3307	3.86	NE567N	2.91
LA1363	4.89	LA7383	1.81	LB1650	5.03	LM339	0.83	LM4894MM.*	2.36	M5238P	0.70	MC14588	0.88	MN3307	3.86	NE567N	2.91
LA1836	1.05	LA7510	2.03	LB1836M*	4.65	LM339N	0.83	LM4894MM.*	2.36	M5238P	0.70	MC14588	0.88	MN3307	3.86	NE567N	2.91
LA1851N	1.30	LA7520	1.84	LB1930M*	1.19	LM3401	2.95	LM4894MM.*	2.36	M5238P	0.70	MC14588	0.88	MN3307	3.86	NE567N	2.91
LA2786	8.89	LA7520	1.84	LC4066	0.29	LM340K-C5	6.21	LM4894MM.*	2.36	M5238P	0.70	MC14588	0.88	MN3307	3.86	NE567N	2.91
LA3201	3.39	LA75503V*	6.69	LC4966	0.64	LM340T12	1.88	LM4894MM.*	2.36	M5238P	0.70	MC14588	0.88	MN3307	3.86	NE567N	2.91
LA3210	2.17	LA75505M*	3.59	LC708031A*	6.89	LM340T15	1.05	LM4894MM.*	2.36	M5238P	0.70	MC14588	0.88	MN3307	3.86	NE567N	2.91
LA3220	2.90	LA75665NV*	3.99	LC7185	7.16	LM340T-15	1.52	LM4894MM.*	2.36	M5238P	0.70	MC14588	0.88	MN3307	3.86	NE567N	2.91
LA3246	0.80	LA75676V-S*1.79		LC72131	1.30	LM340T5	1.34	LM4894MM.*	2.36	M5238P	0.70	MC14588	0.88	MN3307	3.86	NE567N	2.91
LA3361	0.80	LA75676V-S*1.79		LC7218	1.10	LM340T-6	1.13	LM4894MM.*	2.36	M5238P	0.70	MC14588	0.88	MN3307	3.86	NE567N	2.91
LA3400	3.55	LA75676V-S*1.79		LC7236*	6.29	LM340T-8	1.63	LM4894MM.*	2.36	M5238P	0.70	MC14588	0.88	MN3307	3.86	NE567N	2.91
LA3401	1.28	LA7571	3.78	LC74793	3.69	LM348	2.74	LM4894MM.*	2.36	M5238P	0.70	MC14588	0.88	MN3307	3.86	NE567N	2.91
LA3450	9.69	LA7576	0.59	LC74793JM*	3.69	LM34CAZ	6.64	LM4894MM.*	2.36	M5238P	0.70	MC14588	0.88	MN3307	3.86	NE567N	2.91
LA3600	0.58	LA7576V*	0.59	LC7535	2.28	LM350T	6.69	LM4894MM.*	2.36	M5238P	0.70	MC14588	0.				

Order #	(1-9)	Order #	(1-9)	Order #	(1-9)
PBL3717A	\$2.99	SF26	\$1.58	STK392-040	\$15.99
PBU805	3.29	SF36	1.62	STK392-110	14.95
PC111	1.11	SF51	2.69	STK392-120	12.99
PC814	0.55	SF56	2.69	STK392-150	15.95
PC817	0.73	SG3524N	0.53	STK392-180	15.95
PIC16F877-20/L	10.09	SG3255AN	2.02	STK392-560	13.49
PLL02A	20.95	SG613	13.11	STK392-570	17.99
PMT3(310)25010	9.05	SGSF465	9.59	STK393-110	19.44
PN2222	0.20	SI-18751	7.84	STK394-210	13.95
PQ05RD21	2.39	SI-18752	4.45	STK394-250	15.29
PQ30RV31	1.09	SI-3052P	2.90	STK394-510	13.95
PS21352-G	30.32	SI-3090CA	7.03	STK394-710	10.95
PS2501-1	0.38	SI-3122P	10.95	STK396-010	4.61
R1200F	6.39	SI-3122V	10.95	STK400-020	6.39
R1800F	0.29	SK10255	3.01	STK401-040	15.74
R2000F	2.12	SK3173	11.97	STK401-110	15.89
R2M	1.28	SKBK0516	6.93	STK401-120	15.89
RC4136	2.91	SKID0190	11.03	STK401-130	18.70
RC4558	0.85	SKID0194	5.15	STK401-140	28.99
RC4559	3.59	SKID0767	1.09	STK402-030	5.47
RC78L05A	0.35	SKID2502	3.66	STK402-040	8.15
RGP10L	1.45	SKPL6207	15.23	STK402-050	8.99
RGP10G	1.21	SKPRO203	6.25	STK402-070	10.29
RGP10M	1.86	SKPR3513	3.74	STK402-070S	10.29
RGP15J	1.14	SLA7026M	8.44	STK402-071	7.29
RGP15M	1.86	SN7406	1.05	STK402-090	13.99
RH-1X-0137 CEZZ	1.92	SN74LS137N	2.39	STK402-100	9.01
RH-1X-0161 CEZZ	3.47	SN75188	1.04	STK402-100S	16.79
RH-1X-0238 CEZZ	13.00	SN75189	1.04	STK402-120	12.29
RH-1X-1190 CEZZ	5.93	SN76665	4.89	STK402-230	10.81
RH1X1190CEZZ	5.93	SP600	0.93	STK402-240	8.39
RH-1X-1705 CEZZ	23.11	SPC10475	3.86	STK402E	8.97
RH-1X-1750 CEZZ	39.57	SR1620C	5.89	STK4028X	3.69
RH-1X-2163 CEZZ	9.18	SR1630C	5.89	STK402-950	22.95
RH-1X-2447 CEN1	6.61	SR1640C	5.89	STK403-070	12.95
RL207	0.60	SR502	1.07	STK403-090	9.64
RS4FS	3.69	SR503	1.07	STK4032II	6.37
RS604	2.33	SR504	1.07	STK4036II	7.09
RSN3305-P	42.99	SR505	1.07	STK4036X	9.73
S2000A3	1.60	SR506	1.07	STK4038II	11.09
S2000AF	4.64	SSP6N60	2.49	STK4038XII	10.63
S2055AF	4.74	SSP7N60B	1.19	STK404-050	8.29
S2VB20	3.79	SSS6N60A	1.51	STK404-070	8.99
S4VB10	3.53	SSS7N60B	1.79	STK404-090S	11.95
SAB3037	12.95	SS7N80A	11.95	STK4040II	14.48
SB104	3.27	STA301	1.63	STK4040V	20.93
SB154	4.81	STA401	4.09	STK404-130	8.90
SB254	4.81	STA401A	4.09	STK404-140	15.95
SB354	5.59	STA471A	4.99	STK4042II	13.95
SB604	1.94	STE40NA60	20.34	STK4042IV	17.48
SB804G	2.50	STK0050	16.49	STK4044X	9.56
SBX1637-11	13.95	STK0060	19.99	STK4044XII	22.50
SC160B	12.95	STK0070	19.99	STK4046XI	20.47
SE120N	4.62	STK0075	19.99		
SE130N	1.96	STK0080	19.99		
SE135N	5.20	STK0080SQ	19.99		
SE140N	1.28	STK0105	20.95		
SF14	0.39	STK054	19.95		
SF16	1.17	STK078	31.95		
SF161C	3.26	STK078G	31.95		
SF164A	9.11	STK084	16.57		
SF21	1.58	STK1030	28.86		
SF24	1.58	STK1035	12.87		
		STK1039	12.87		
		STK1040	28.86		
		STK1049	12.87		
		STK1050	28.86		
		STK1050II	18.05		
		STK1060II	18.05		
		STK2250	23.68		
		STK3042	11.62		
		STK3042III	9.08		
		STK3082II	14.65		
		STK3082III	11.92		
		STK3102II	12.99		
		STK3152II	14.10		
		STK350-030	12.99		
		STK350-230	7.99		
		STK391-020	9.99		
		STK392-010	11.95		
		STK392-020	14.99		

Order #	(1-9)	Order #	(1-9)	Order #	(1-9)
STK4048II	\$18.95	STK426-530	\$52.37	STP55NE06FP	\$0.83
STK4048V	19.69	STK4273	6.89	STR10006	10.95
STK4048XI	13.65	STK4274	6.89	STR10006	7.03
STK405-030	6.98	STK4277	17.35	STR12006	12.58
STK405-050	6.98	STK4278	13.80	STR15006	13.95
STK405-050A	6.98	STK4278L	14.25	STR2012	3.25
		STK428-610	29.95	STR2012A	3.25
		STK428-640	29.95	STR2013	10.95
		STK4311	17.95	STR30110	6.16
		STK432-070	21.95	STR30115Z	2.00
		STK437	19.95	STR30123S	5.36
		STK4372	10.20	STR30123Z	5.36
		STK439	19.95	STR30125S	6.37
		STK4392	10.20	STR30125Z	6.37
		STK441	6.25	STR30130S	3.05
		STK4412	6.25	STR30130Z	2.69
		STK442-110	9.90	STR30134S	2.44
		STK442-120	12.95	STR30134Z	2.44
		STK442-130	12.99	STR30135S	2.60
		STK443-070	14.49	STR30135Z	2.40
		STK460	20.65	STR3035	7.49
		STK461	20.65	STR3115	8.39
		STK463	33.85	STR3123	5.40
		STK465	33.85	STR3130	8.99
		STK470-010A	23.95	STR3220	2.53
		STK470-020A	14.99	STR3230	3.62
		STK470-050A	15.89	STR4142	15.17
		STK4843	11.18	STR50041	4.55
		STK4863	17.71	STR5041S	5.56
		STK488-010	6.68	STR51041Z	3.05
		STK490-070	5.34	STR52041	7.00
		STK490-140	19.77	STR53041S	8.59
		STK490-310	13.90	STR55041Z	6.15
		STK4913	22.43	STR54041	16.95
		STK496-070	13.96	STR54041S	16.95
		STK496-090	19.75	STR55041Z	5.38
		STK499-070	10.58	STR57041	5.98
		STK5342	4.99	STR58041	9.99
		STK5436	9.95	STR58041S	9.99
		STK5441	9.37	STR58041Z	9.99
		STK5474	3.59	STR6301	8.49
		STK5477	16.95	STR81145S	9.59
		STK5479	18.95	STR81145Z	9.59
		STK5481	9.54	STRD1005	7.89
		STK5486	10.95	STRD1206	5.99
		STK563	23.80	STRD3030	8.86
		STK563F	23.80	STRD3035	4.96
		STK583	6.27	STRD6004	6.98
		STK583F	6.27	STRD6602	4.76
		STK6942	7.19	STRD6801	7.45
		STK6962	5.39	STRF6424	6.25
		STK6972	9.95	STRF6426	5.25
		STK7217	7.65	STRF6514	8.99
		STK7251	12.87	STRF6515	11.31
		STK730-010	9.99	STRF6516	10.99
		STK730-020	8.99	STRF6624	6.33
		STK730-030	12.89	STRF6626	8.50
		STK730-040	9.59	STRF6628	8.72
		STK730-080	7.10	STRF6629B	9.89
		STK730-090	14.91	STRF6656	5.79
		STK730-130	15.95	STRG6624	5.99
				STRG6653	4.59
				STRG9656	15.95
				STRM6511	9.99
				STRM6515	10.12
				STRM6545	6.50
				STRM6546	7.05
				STRM6811	13.95
				STRS5041	5.89
				STRS5041G	17.75
				STRS5141	9.99
				STRS5141G	9.99
				STRS5241	10.99
				STRS5241G	10.99
				STRS5703	12.17
				STRS5707	14.99
				STRS5708	9.28
				STRS5717	4.64
				STRS5741	5.24
				STRS5741	5.24
				STRS6301	8.49
				STRS6301A	9.99
				STRS6302	5.76
				STRS6501	14.75
				STRS6511	10.25
				STRS6514	3.51
				STRS6707	14.99
				STRS6708	6.67
				STRS6709	7.19
				STRW6756	5.99

Order #	(1-9)	Order #	(1-9)	Order #	(1-9)
STR22151	\$13.28	STR22151	16.91	STRZ2151	\$13.28
STR22751	16.91	STR24117	21.99	STRZ4214	13.99
STR24117	21.99	STRZ4214	13.99	STRZ4317	16.95
STRZ4214	13.99	STV7778	4.60	STV8172A	2.89
STRZ4317	16.95	STV9379	4.99	SV87701VHC	29.04
STV7778	4.60	T2508	1.92	TA1201AN	8.60
STV9379	4.99	TA1201AN	8.60	TA1218AN	8.99
SV87701VHC	29.04	TA12228N	9.29	TA1223AN	5.70
		TA1223AN	5.70	TA1223N	5.70
		TA1242	11.55	TA1242N	11.55
		TA1252AN	20.01	TA1252AN	20.01
		TA1268N	7.99	TA1268N	7.99
		TA1276AN	8.99	TA1282N	8.59
		TA1282N	8.59	TA1291N	4.38
		TA1291N	4.38	TA1310N	10.39
		TA1310N	10.39	TA1316AN	20.59
		TA1316AN	20.59	TA2092N	3.28
		TA2092N	3.28	TA27060	3.62
		TA27060	3.62	TA7061	4.38
		TA7061	4.38	TA7069	4.38
		TA7069	4.38	TA7120	4.56
		TA7120	4.56	TA7122	4.56
		TA7122	4.56	TA7140	3.84
		TA7140	3.84	TA7205	1.84
		TA7205	1.84	TA7208	6.19
		TA7208	6.19	TA7214	6.89
		TA7214	6.89	TA7217	1.84
		TA7217	1.84	TA7222	2.29
		TA7222	2.29	TA7230	2.25
		TA7230	2.25	TA7240	2.54
		TA7240	2.54	TA7250	4.95
		TA7250	4.95	TA7252	2.49
		TA7252	2.49	TA7252AP	2.49
		TA7252AP	2.49	TA7257	4.10
		TA7257	4.10	TA7259	3.27
		TA7259	3.27	TA7263	2.54
		TA7263	2.54	TA7265AP	9.59
		TA7265AP	9.59	TA7267	1.80
		TA7267	1.80	TA7267BP	1.80
		TA7267BP	1.80	TA7270	3.00
		TA7270	3.00	TA7280	2.69
		TA7280	2.69	TA7281	6.19
		TA7281	6.19	TA7281P	6.19

Order #	(1-9)	Order #	(1-9)	Order #	(1-9)	Order #	(1-9)	Order #	(1-9)	Order #	(1-9)
TDA1675	\$5.99	TDA7385	\$16.47	TIP31A	\$0.99	UPA81	\$5.29	UPC7818H	\$1.13	1N4731A	\$0.29
TDA1675A	5.99	TDA7386	19.99	TIP31B	1.22	UPC1026	4.89	UPC7824	0.33	1N4732	0.29
TDA1771	6.99	TDA7396	4.99	TIP31C	1.22	UPC1028	4.89	UPC7893AHF	0.15	1N4732A	0.29
TDA1905	3.48	TDA7454	12.11	TIP32	0.76	UPC1031	2.19	UPC78L05A	0.33	1N4733	0.29
TDA2002	2.10	TDA7496	2.17	TIP32A	0.76	UPC1032	0.68	UPC78L08	2.00	1N4733A	0.29
TDA2003	2.55	TDA7499	4.30	TIP32B	0.76	UPC1042	13.75	UPC78L12A	0.35	1N4734	0.29
TDA2004	9.39	TDA7560	16.49	TIP32C	0.76	UPC1042C	13.75	UPC7906H	0.54	1N4734A	0.29
TDA2005	0.93	TDA8132	3.29	TIP33	3.21	UPC1094	2.46	UPC7912	0.55	1N4735	0.29
TDA2006	4.10	TDA8133	5.41	TIP33C	3.21	UPC1158	3.14	UPC7918	1.22	1N4735A	0.29
TDA2007	3.00	TDA8137	1.38	TIP34	1.94	UPC1167	6.69	UPD16312GBM*		1N4736	0.29
TDA2009	5.36	TDA8139	3.19	TIP34C	3.66	UPC1181	10.95		2.77	1N4736A	0.29
TDA2030	2.45	TDA8145	1.80	TIP35	3.73	UPC1182	11.95	UPD1987	5.89	1N4737	0.29
TDA2030A	2.32	TDA8170	3.39	TIP35B	3.73	UPC1185	12.95	UPD2716	20.95	1N4737A	0.29
TDA2030V	2.45	TDA8172	2.89	TIP35C	3.89	UPC1188	6.99	UPD4011	0.64	1N4738	0.29
TDA2040	4.50	TDA8174	2.39	TIP36A	4.96	UPC1188H	6.99	UPD4013BC	0.72	1N4738A	0.29
TDA2050	7.29	TDA8174AW	1.69	TIP36B	4.96	UPC1212	0.44	UPD4073	0.69	1N4739	0.29
TDA2052	4.64	TDA8177	2.82	TIP36C	4.45	UPC1213	2.72	V-11N	1.86	1N4739A	0.29
TDA2540	9.95	TDA8179S	4.99	TIP41	1.34	UPC1225	4.42	V130LA10A	0.67	1N4740	0.29
TDA2546	9.49	TDA8216	5.90	TIP41A	1.34	UPC1228	0.44	V251BA60	105.01	1N4740A	0.29
TDA2577	8.69	TDA8350	5.29	TIP41B	1.34	UPC1237	0.97	V571BA60	163.42	1N4741	0.29
TDA2593	2.16	TDA8350Q	5.29	TIP41C	1.34	UPC1237HA	0.97	V661BA60	163.42	1N4741A	0.29
TDA2595	6.87	TDA8351	7.19	TIP42	1.14	UPC1238	1.60	V77-3S17D8-048		1N4742	0.29
TDA2611	0.87	TDA8356	2.31	TIP42A	1.43	UPC1242	4.23		2.93	1N4742A	0.29
TDA2616	3.15	TDA8357	2.88	TIP42B	1.43	UPC1251	2.97	V751BA60		1N4743	0.29
TDA2653	6.63	TDA8359J	3.29	TIP42C	1.43	UPC1252	7.29		163.42	1N4743A	0.29
TDA2653A	6.63	TDA8361A	10.05	TIP47	0.96	UPC1270	5.63	VERSAFIT-1/2-KT1		1N4744	0.29
TDA2658	8.69	TDA8369	12.16	TIP50	1.51	UPC1316	2.48		7.65	1N4744A	0.29
TDA2822M	0.49	TDA8373	27.95	TIPL762A	8.29	UPC1316C	2.48	VM88	2.26	1N4745	0.29
TDA3569	4.31	TDA8377	22.33	TL062CN	0.45	UPC1350	5.69	VN2222LL	0.32	1N4745A	0.29
TDA3652	11.95	TDA8380	3.27	TL071C	2.04	UPC1353	5.99	VP512	16.77	1N4746	0.29
TDA3653	1.21	TDA8425	12.83	TL071CN	2.04	UPC1363CA	8.09	W04	0.93	1N4746A	0.29
TDA3653C	7.99	TDA8444	1.17	TL072	0.85	UPC1366	6.19	WDCT-06-7226.98		1N4747	0.29
TDA3654Q	4.38	TDA8510J	5.89	TL072CN	0.85	UPC1373	3.47	WDCT-08-7228.84		1N4747A	0.29
TDA3682ST	5.09	TDA8560	9.42	TL072CP	0.85	UPC1373H	3.47	WDCT-12-7237.21		1N4748	0.29
TDA4190	5.77	TDA8561	4.05	TL074CN	1.61	UPC1373HA	3.47	WDCT-16-7245.59		1N4748A	0.29
TDA4505E	15.95	TDA8561Q	4.05	TL081CP	0.48	UPC1377	4.95	XTR101AG	57.12	1N4749	0.29
TDA4600	5.13	TDA8567Q	13.25	TL082	1.50	UPC1378	13.00	Z130B	1.88	1N4749A	0.29
TDA4600-2	5.13	TDA8568Q	14.88	TL084CH	1.53	UPC1378H	13.00	Z160B	1.88	1N4750	0.29
TDA4601	5.13	TDA8571J	22.99	TL084CN	1.53	UPC1379	2.75	Z200B	1.88	1N4750A	0.29
TDA4605	3.99	TDA8580J	10.25	TL431C	0.89	UPC1382	5.39	ZTX300	1.26	1N4751	0.29
TDA4800	11.95	TDA8841	14.95	TL431CLP	0.49	UPC1391	2.66	10.5V 1W	0.29	1N4751A	0.29
TDA4851	1.89	TDA8944J	3.99	TL431CP	0.89	UPC1391H	2.66	10V 1/2W	0.19	1N4752	0.29
TDA4853	4.32	TDA9102C	3.71	TL494CN	1.90	UPC1391HA	2.66	11V 1/2W	0.19	1N4752A	0.29
TDA4854	11.32	TDA9103	3.72	TL783C	5.19	UPC1394	4.57	11V 1W	0.29	1N4753	0.29
TDA4855	4.19	TDA9105	7.07	TLP3043	2.49	UPC1397	6.75	12V 1/2W	0.19	1N4753A	0.29
TDA4856	4.03	TDA9109	9.39	TLP504A-2	1.25	UPC1397C	6.75	12V 1W	0.29	1N4754	0.29
TDA4858	6.18	TDA9109A	9.39	TLP521-1	0.25	UPC1401	13.95	13V 1/2W	0.19	1N4754A	0.29
TDA4861	2.44	TDA9302	3.99	TLP621	3.39	UPC1401CA	13.95	13V 1W	0.29	1N4755	0.29
TDA4866	1.27	TDA9302H	3.99	TLP627	0.82	UPC1402	13.95	15V 1/2W	0.19	1N4755A	0.29
TDA4881	1.90	TDA9533	2.83	TL5233N	8.17	UPC1406	0.88	15V 1W	0.29	1N4756	0.29
TDA4950	0.98	TEA2025B	0.56	TMS320C31POL60		UPC141	1.77	16V 1/2W	0.19	1N4756A	0.29
TDA5030	2.73	TEA2037	5.01		48.47	UPC1458	0.85	16V 1W	0.29	1N4757A	0.29
TDA6101Q	0.87	TEA2037A	5.01	TSA5511	2.70	UPC1470	1.69	16V 400MW	0.79	1N4758A	0.29
TDA6103Q	3.84	TEA2261	5.09	TSA5515T*	4.95	UPC1480CA	9.95	18V 1/2W	0.19	1N4759	0.49
TDA6106Q	1.15	TEA2262	3.85	TT2140LS	2.39	UPC1481	9.95	18V 1W	0.29	1N4760	0.40
TDA6107JF	2.09	TEA3718	3.49	TYN825	1.27	UPC1486	3.70	19V 1/2W	0.19	1N4762	0.40
TDA6107Q	3.07	TEA3718DP	3.49	UA555	0.60	UPC1488	7.70	1B22AN	120.43	1N4763	0.40
TDA6108	5.49	TEA3718SDP	1.89	UA723CN	2.10	UPC1490	3.67	1N34A	1.83	1N4764	0.51
TDA6108JF	5.49	TEA3718SP	3.49	UA733	2.07	UPC1498	11.26	1N3600	1.13	1N4933	0.15
TDA6111Q	3.30	TEA5170	2.98	UA741CN	1.58	UPC151C	1.02	1N3660	3.90	1N4934	0.15
TDA6120Q	5.25	TEA5582	5.89	UA741CP	1.28	UPC1520	6.19	1N3754	0.72	1N4935	0.17
TDA7000	2.75	TEA6320T*	14.79	UA747CN	0.68	UPC1571	1.26	1N4001	0.05	1N4936	0.19
TDA7052	4.29	TIC206D	3.06	UA767	5.69	UPC177	2.74	1N4001F	0.05	1N4936G	0.19
TDA7053	1.15	TIP100	1.96	UA7806	1.04	UPC1870CA	9.75	1N4002	0.08	1N4937	0.27
TDA7057AQ	4.16	TIP102	1.31	UA7809	1.62	UPC1871CU	9.38	1N4002F	0.08	1N4937G	0.27
TDA7057Q	4.16	TIP107	1.65	UA7815KC	1.52	UPC2002	2.10	1N4003	0.08	1N4948	0.45
TDA7073	2.46	TIP110	1.10	UA78L09	1.76	UPC2505H	6.00	1N4003F	0.08	1N5062	1.54
TDA7231	3.11	TIP115	1.18	UA78L12	1.22	UPC2581	10.95	1N4004	0.05	1N5221	0.55
TDA7235	1.89	TIP116	2.26	UA7915	0.62	UPC2581V	10.95	1N4004F	0.05	1N5222	0.55
TDA7240	1.65	TIP117	2.26	UA7924CKC	3.38	UPC319C	4.31	1N4005	0.08	1N5223	0.55
TDA7240A	1.65	TIP120	1.34	UC3842	3.65	UPC324	0.55	1N4005F	0.08	1N5224	0.75
TDA7262	3.09	TIP121	1.12	UC3842AN	3.65	UPC339C	2.74	1N4006	0.08	1N5225	0.55
TDA7263	1.88	TIP122	1.30	UC3844	7.28	UPC358	2.97	1N4006F	0.08	1N5226	0.19
TDA7265	11.99	TIP125	1.68	UCN5815A	3.11	UPC393	0.69	1N4007	0.05	1N5226B	0.19
TDA7266	2.17	TIP126	1.56	UES1104	4.09	UPC393C	0.69	1N4007	0.05	1N5227	0.19
TDA7266L	0.45	TIP127	1.34	UF1602CT	2.73	UPC4081	3.88	1N4007F	0.05	1N5227B	0.19
TDA7267	5.87	TIP135	1.34	UF4007	1.04	UPC4557C	3.62	1N4148	0.06	1N5228	0.19
TDA7269A	3.50	TIP140	3.33	UF5404	0.84	UPC4558	0.37	1N4149	0.22	1N5228B	0.19
TDA7293V	8.39	TIP141	2.93	ULN2003	3.70	UPC4558C	0.37	1N4151	0.14	1N5229	0.19
TDA7294	6.99	TIP142	2.96	ULN2003A	0.73	UPC4560*	0.58	1N4153	1.13	1N5229B	0.19
TDA7294V	6.99	TIP146	2.91	ULN2004A	0.73	UPC4560C	1.53	1N4154	1.13	1N5230	0.19
TDA7295	9.42	TIP147	3.90	ULN2004AP	0.59	UPC4570	0.45	1N4370	0.55	1N5230B	0.19
TDA7296	5.74	TIP29	0.92	ULN2068B	2.88	UPC4570C	0.45	1N4448	0.22	1N5231	0.19
TDA7315	3.49	TIP2955	2.93	ULN2069B	0.87	UPC4570HA	0.98	1N4449	1.13	1N5231B	0.19
TDA7350	4.91	TIP29A	0.92	ULN2224	7.99	UPC4574C	0.77	1N4590	14.37	1N5232	0.19
TDA7370	4.37	TIP29B	0.92	ULN2803	2.59	UPC494	3.37	1N46	0.32	1N5232B	0.19
TDA7370V	4.37	TIP29C	0.92	ULN2803A	2.59	UPC494C	3.37	1N4728	0.29	1N5233	0.19
TDA7375	8.79	TIP30	0.98	ULN2803A	2.59	UPC554	7.39	1N4728A	0.29	1N5233B	0.19
TDA7377	7.30	TIP3055	2.27	ULN2804A	0.98	UPC574	1.20	1N4729	0.29	1N5234	0.19
TDA7381	16.77	TIP30A	0.98	UPA53	0.22	UPC575	9.09	1N4729A	0.29	1N5234B	0.19
TDA7383	38.56	TIP30B	0.98	UPA53C	0.22	UPC741	1.02	1N4730	0.29	1N5235	0.19
TDA7384	14.75	TIP30C	0.98	UPA672T*	0.59	UPC7818	1.22	1N4730A	0.29	1N5235B	0.19
TDA7384A	13.99	TIP31	1.04	UPA79C	2.80			1N4731	0.29	1N5236	0.19

Order #	(1-9)	Order #	(1-9)	Order #	(1-9)
1N5236B	\$0.19	1N5822	\$0.91	2N3228	\$10.95
1N5237	0.19	1N60	0.32	2N3304	1.33
1N5237B	0.19	1N6263	2.44	2N3391	1.11
1N5238	0.19	1N6267	3.44	2N3392	0.55
1N5239	0.19	1N6282	1.25	2N3393	0.55
1N5239B	0.19	1N6284A	0.79	2N3397	0.55
1N5240B	0.19	1N6284C	1.19	2N3403	2.54
1N5241	0.19	1N6303			

Order #	(1-9)	Order #	(1-9)	Order #	(1-9)
2N5322	\$3.34	2N697	\$0.85	2SA1154	\$0.33
2N5400	0.71	2N7000	0.99	2SA1156	0.69
2N5401	0.53	2N879	1.15	2SA1161	0.48
2N5415	2.27	2SA1005	0.06	2SA1162	1.76
2N5416	1.68	2SA1006	0.81	2SA1163	2.04
2N5457	1.75	2SA1007	7.19	2SA1169	7.99
2N5458	1.51	2SA1008	1.73	2SA1170	7.99
2N5459	0.96	2SA101	9.09	2SA1171*	2.04
2N5460	1.22	2SA1011	0.62	2SA1174	0.25
2N5461	1.89	2SA1012	1.37	2SA1175	0.25
2N5462	1.53	2SA1013	0.58	2SA1177	0.04
2N5484	1.31	2SA1015	0.23	2SA1179*	2.13
2N5486	0.84	2SA1016	0.18	2SA1182*	2.13
2N5490	3.01	2SA1017	0.28	2SA1185	4.99
2N5550	0.51	2SA1019	0.30	2SA1186	4.25
2N5551	0.99	2SA102	9.09	2SA1187	8.90
2N5563	6.95	2SA1020	0.50	2SA1188	2.19
2N5568	1.75	2SA1021	1.50	2SA1189	0.38
2N5569	1.05	2SA1022*	0.16	2SA1190	2.19
2N5565	2.19	2SA1023	0.41	2SA1191	0.38
2N5571	18.95	2SA1025	0.41	2SA1193	0.16
2N5580	4.09	2SA1029	0.46	2SA1194	2.50
2N5571	2.86	2SA103	9.09	2SA1198	0.23
2N5581	0.48	2SA1030	0.17	2SA1204*	0.37
2N5583	0.84	2SA1031	0.46	2SA1207	0.21
2N5584	10.30	2SA103228-		2SA1208	0.48
2N5586	6.81	330528-3270	0.17	2SA1209	0.33
2N5591	1.68	2SA1034*	1.76	2SA121	1.23
2N6027	1.34	2SA1036*	2.13	2SA1210	0.80
2N6029	12.95	2SA1037*	0.07	2SA1213*	0.37
2N6030	10.30	2SA1038	0.15	2SA1215	5.58
2N6034	2.50	2SA1039	0.28	2SA1216	8.90
2N6036	2.50	2SA104	9.09	2SA1220	0.39
2N6037	2.25	2SA1040	7.19	2SA1221	0.54
2N6039	2.25	2SA1045	8.59	2SA1226*	2.13
2N6043	2.53	2SA1047	0.87	2SA1227	4.80
2N6052	5.81	2SA1048	0.06	2SA1232	3.89
2N6053	4.43	2SA1050	7.19	2SA1239	0.42
2N6059	2.69	2SA1051	7.19	2SA124	1.23
2N6075	1.58	2SA1052*	0.06	2SA1240	0.42
2N6125	3.21	2SA1061	4.04	2SA1241	0.66
2N6126	0.71	2SA1062	4.99	2SA1244	0.66
2N6211	6.95	2SA1065	7.19	2SA1245*	2.95
2N6254	6.81	2SA1066	0.23	2SA1246	0.12
2N6259	12.17	2SA1068	7.19	2SA1248	0.43
2N6282	7.56	2SA1072	7.19	2SA1249	0.43
2N6284	6.60	2SA1073	7.19	2SA1252*	0.20
2N6285	8.21	2SA1078	4.56	2SA1254	0.10
2N6287	8.21	2SA1081	1.65	2SA1255	1.90
2N6328	7.70	2SA1082	0.38	2SA1256*	0.16
2N6331	1.84	2SA1083	1.65	2SA1258	0.45
2N6344	6.16	2SA1085	0.38	2SA1259	1.91
2N6346A	3.90	2SA1091	0.34	2SA1263	1.12
2N6387	1.30	2SA1093	1.62	2SA1263N	1.12
2N639	24.95	2SA1101	0.41	2SA1264	2.42
2N6395	3.20	2SA1102	1.41	2SA1264N	2.42
2N6397	5.79	2SA1103	1.68	2SA1265	3.10
2N6400	3.43	2SA1104	1.68	2SA1266	1.03
2N6421	9.30	2SA1105	5.19	2SA1267	0.06
2N6427	1.86	2SA1106	5.19	2SA1270	1.39
2N6474	3.09	2SA1111	0.88	2SA1271	1.39
2N6476	3.39	2SA1112	1.97	2SA1273	0.11
2N6487	2.58	2SA1115	0.29	2SA1276	1.38
2N6488	1.89	2SA1121*	2.13	2SA1282	0.27
2N6490	1.75	2SA1122*	0.20	2SA1284	2.19
2N6491	2.10	2SA1123	0.28	2SA1289	1.40
2N6505	4.11	2SA1124	0.38	2SA1290	1.40
2N6507	4.24	2SA1125	0.44	2SA1291	2.42
2N6520	0.60	2SA1127	0.10	2SA1293	0.84
2N6551	8.39	2SA1129	0.46	2SA1294	5.99
2N6552	3.43	2SA1133	0.41	2SA1295	8.76
2N6554	5.00	2SA1135	1.41	2SA1296	2.33
2N6555	5.00	2SA1138	0.79	2SA1298*	0.16
2N6576	4.79	2SA114	6.39	2SA1301	4.61
2N6673	10.95	2SA1141	4.99	2SA1302	4.49
2N6714	1.45	2SA1142	0.44	2SA1303	5.98
2N6716	1.34	2SA1144	1.50	2SA1304	1.70
2N6718	2.95	2SA1145	0.48	2SA1305	0.45
2N6720	2.56	2SA1146	1.62	2SA1306	1.70
2N6723	2.56	2SA1150	1.54	2SA1309	0.29
2N6728	1.13	2SA1151	0.10	2SA1309A	0.29
2N681	5.99	2SA1152	0.53	2SA1316	0.23

Order #	(1-9)	Order #	(1-9)	Order #	(1-9)
2SA1317	\$0.04	2SA1633	\$5.45	2SA675	\$0.23
2SA1318	0.41	2SA1643	2.95	2SA679	7.19
2SA1320	0.33	2SA1656	0.04	2SA680	7.19
2SA1321	1.00	2SA1667	1.25	2SA681	2.28
2SA1328	0.46	2SA1668	4.33	2SA682	0.52
2SA1330*	3.42	2SA1670	1.81	2SA683	0.35
2SA1333	5.29	2SA1671	2.61	2SA684	0.35
2SA1341*	1.71	2SA1672	6.33	2SA702	0.07
2SA1344*	1.71	2SA1673	7.09	2SA708	2.28
2SA1345	0.04	2SA1680	0.83	2SA719	0.27
2SA1346	0.04	2SA1684	0.57	2SA720	0.15
2SA1347	0.04	2SA1694	5.79	2SA721	0.17
2SA1348	0.04	2SA1695	5.29	2SA722	0.10
2SA1349	1.69	2SA1701	0.26	2SA723	0.59
2SA1352	0.41	2SA1706	0.26	2SA724	0.59
2SA1353	0.44	2SA1708	0.49	2SA733	0.03
2SA1356	1.54	2SA1725	4.52	2SA738	2.61
2SA1358	1.54	2SA1726	1.80	2SA740	0.62
2SA1360	0.39	2SA1803	2.13	2SA741	1.33
2SA1362*	0.16	2SA1837	1.49	2SA743	2.61
2SA1363*	0.80	2SA1859	0.71	2SA744	8.59
2SA1364*	1.39	2SA1859A	0.71	2SA745	8.59
2SA1365*	0.35	2SA1860	4.17	2SA746	8.59
2SA1369	0.80	2SA1907	1.94	2SA747	8.59
2SA1370	0.50	2SA1908	2.48	2SA748	0.45
2SA1371	0.30	2SA1909	4.39	2SA750	1.05
2SA1376	0.28	2SA1930	1.47	2SA753	7.19
2SA1380	0.43	2SA1939	1.03	2SA755	0.71
2SA1381	0.44	2SA1940	3.94	2SA757	8.59
2SA1382	0.50	2SA1941	3.89	2SA758	7.19
2SA1386	6.99	2SA1942	5.29	2SA760*	1.05
2SA1387	3.21	2SA1943	5.29	2SA762	7.45
2SA1388	1.22	2SA1962	4.99	2SA763	0.53
2SA1391	0.41	2SA1986	3.32	2SA764	7.45
2SA1392	0.41	2SA1987	5.00	2SA765	7.45
2SA1394	1.22	2SA221	4.99	2SA768	0.60
2SA1398	0.31	2SA321	4.99	2SA769	2.74
2SA1399	0.28	2SA322	4.99	2SA770	2.74
2SA1402	2.20	2SA324	4.99	2SA771	3.48
2SA1403	2.20	2SA350	9.09	2SA772	0.60
2SA1406	0.87	2SA351	9.09	2SA777	0.83
2SA1407	3.52	2SA353	6.39	2SA778	0.33
2SA1408	1.50	2SA354	6.39	2SA780	2.38
2SA1409	0.27	2SA355	6.39	2SA781	0.27
2SA1420	1.03	2SA403	4.99	2SA785	1.65
2SA1423	0.23	2SA429	0.28	2SA786	0.12
2SA1426	0.35	2SA435	4.99	2SA790	0.21
2SA1428	0.35	2SA467	0.19	2SA794	1.22
2SA1430	0.35	2SA473	1.38	2SA798	1.88
2SA1435	0.27	2SA484	4.09	2SA799	2.28
2SA1436	0.41	2SA485	4.09	2SA808	8.59
2SA1441	4.56	2SA489	1.13	2SA811*	1.65
2SA1450	1.56	2SA499	9.09	2SA811A	2.04
2SA1453	0.06	2SA499	9.09	2SA812*	0.06
2SA1462*	0.16	2SA493	1.03	2SA814	0.72
2SA1474	0.81	2SA494	0.15	2SA815	1.73
2SA1475	0.72	2SA495	0.53	2SA816	0.69
2SA1479	0.44	2SA497	0.88	2SA817	0.13
2SA1481	0.04	2SA503	4.09	2SA821	0.33
2SA1489	4.80	2SA504	2.28	2SA823	0.07
2SA1490	4.35	2SA505	0.43	2SA825	1.82
2SA1491	4.35	2SA509	1.39	2SA826	0.07
2SA1492	3.39	2SA510	4.09	2SA836	1.05
2SA1493	7.47	2SA52	9.09	2SA837	8.59
2SA1494	7.99	2SA53	4.99	2SA838	0.13
2SA1495*	2.31	2SA537	2.28	2SA839	3.04
2SA1496*	3.21	2SA539	0.53	2SA841	0.15
2SA1497	0.04	2SA544	2.28	2SA842	0.15
2SA1503	0.04	2SA546	2.28	2SA844	0.17
2SA1507	0.38	2SA550	1.65	2SA847	0.48
2SA1516	3.89	2SA559	1.65	2SA850	0.34
2SA152	4.99	2SA564	0.06	2SA857	0.28
2SA1528	0.19	2SA566	5.09	2SA858	0.28
2SA1534	0.18	2SA574	0.10	2SA872	0.26
2SA1535	0.85	2SA606	4.09	2SA874	1.05
2SA1536	0.38	2SA608	0.06	2SA879	1.00
2SA1537	0.38	2SA609	0.17	2SA883	0.41
2SA1539	0.38	2SA610	0.17	2SA885	0.52
2SA1540	0.37	2SA621	0.88	2SA886	0.96
2SA1553	3.99	2SA627	8.59	2SA892	2.26
2SA1554	0.23	2SA634	1.19	2SA893	0.30
2SA1555	0.07	2SA638	0.28	2SA899	1.03
2SA1561	0.39	2SA639	0.28	2SA900	0.52
2SA1562	0.80	2SA640	0.07	2SA904	0.48
2SA1564	0.04	2SA641	0.07	2SA905	0.48
2SA1567	2.95	2SA642	0.17	2SA907	7.19
2SA1576*	0.08	2SA649	7.19	2SA908	7.19
2SA1582	0.04	2SA657	8.59	2SA912	0.38
2SA1594*	0.08	2SA659	0.19	2SA913	0.44
2SA1618*	1.39	2SA666	0.06	2SA914	0.96
2SA1624	1.56	2SA671	0.58	2SA915	0.79
2SA1625	1.56	2SA672	0.14	2SA916	0.32
		2SA673	0.55	2SA917	0.48

Order #	(1-9)	Order #	(1-9)	Order #	(1-9)
2SA921	\$0.41	2SB1238	\$0.23	2SB549	\$1.50
2SA925	0.27	2SB1240	0.07	2SB553	1.40
2SA928	0.23	2SB1243	0.39	2SB554	7.19
2SA929	0.03	2SB126	8.59	2SB555	7.19
2SA933	0.07	2SB1261	0.56	2SB556	7.19
2SA934	0.14	2SB1274	0.48	2SB557	8.59
2SA935	0.23	2SB1287	2.26	2SB558	8.59
2SA936	0.59	2SB1292	3.21	2SB559	2.61
2SA937	0.12	2SB1299	0.99	2SB560	0.34
2SA939	3.61	2SB1317	8.99	2SB561	0.27
2SA940	0.44	2SB1328	1.39	2SB562	0.09
2SA941	0.48				

Order #	(1-9)	Order #	(1-9)	Order #	(1-9)
2SC2853	\$0.60	2SC3082*	\$0.24	2SC3211	\$6.59
2SC2854	0.60	2SC3082K*	0.24	2SC3212	9.59
2SC2855	1.79	2SC3083	3.32	2SC3219	1.06
2SC2856	0.60	2SC3084	11.95	2SC3220	3.21
2SC2857	0.12	2SC3086	2.56	2SC3225	0.70
2SC2867	1.05	2SC3088	6.59	2SC3226	0.17
2SC2868	0.19	2SC3089	9.59	2SC3227	0.21
2SC2872	1.88	2SC3090	5.89	2SC3229	5.04
2SC2873*	0.27	2SC3091	19.95	2SC3230	0.38
2SC2874	0.09	2SC3099*	0.15	2SC3231	3.77
2SC2875	0.06	2SC3104	24.20	2SC3242	0.33
2SC2877	1.13	2SC3110*	0.81	2SC3243	2.17
2SC2878	0.19	2SC3112	1.11	2SC3244	0.53
2SC2883*	0.27	2SC3113	0.29	2SC3246	0.12
2SC2884*	0.27	2SC3114	0.17	2SC3249	0.86
2SC2898	7.99	2SC3116	0.39	2SC3253	3.55
2SC2900	2.02	2SC3117	0.39	2SC3254	3.55
2SC2901	0.21	2SC3119*	0.15	2SC3256	5.89
2SC2907	1.06	2SC3120*	0.14	2SC3258	2.40
2SC2909	0.12	2SC3121*	0.14	2SC3259	2.56
2SC2910	0.18	2SC3123*	0.14	2SC3260	6.59
2SC2911	0.51	2SC3124*	0.14	2SC3261	6.59
2SC2912	1.30	2SC3125*	0.14	2SC3262	9.59
2SC2914	11.95	2SC3127*	0.81	2SC3263	6.29
2SC2918	0.47	2SC3128	1.86	2SC3264	3.98
2SC2921	5.99	2SC3130*	0.15	2SC3265*	2.03
2SC2922	8.39	2SC3133	7.09	2SC3266	0.25
2SC2923	2.19	2SC3134	2.03	2SC3268*	0.27
2SC2926	0.14	2SC3135	0.06	2SC3271	0.27
2SC2926S	0.26	2SC3136	1.86	2SC3272	2.19
2SC2928	14.95	2SC3138*	1.90	2SC3273	1.43
2SC2929	0.27	2SC3142*	0.14	2SC3274	1.43
2SC2931	24.20	2SC3144	1.64	2SC3275	1.43
2SC2932	28.95	2SC3145	1.64	2SC3277	1.58
2SC2937	3.21	2SC3148	2.56	2SC3279	0.25
2SC2938	3.21	2SC3150	2.38	2SC3280	4.50
2SC2939	3.21	2SC3151	2.85	2SC3281	4.99
2SC2954*	3.13	2SC3152	2.85	2SC3284	5.29
2SC2958	0.33	2SC3153	2.85	2SC3285	1.50
2SC2959	0.33	2SC3156	14.95	2SC3294	0.73
2SC2960	0.06	2SC3158	4.03	2SC3295*	0.08
2SC2961	6.13	2SC3159	4.03	2SC3296	1.33
2SC2963	2.40	2SC3160	4.03	2SC3298	2.29
2SC2979	2.43	2SC3161*	0.08	2SC3299	2.40
2SC2982*	0.27	2SC3164	3.21	2SC3300	6.94
2SC2983	1.01	2SC317	0.47	2SC3303	1.94
2SC2986	0.28	2SC3170	2.77	2SC3306	2.75
2SC2987	5.98	2SC3171	7.99	2SC3307	20.27
2SC2995	0.06	2SC3173	7.99	2SC3310	1.38
2SC2996*	2.03	2SC3174	1.06	2SC3311	0.11
2SC2998	0.15	2SC3175	1.08	2SC3311A	0.11
2SC2999	1.60	2SC3176	1.06	2SC3313	0.11
2SC3000	0.16	2SC3177	1.43	2SC3314	0.11
2SC3005*	0.81	2SC3179	0.80	2SC3315	0.11
2SC3006	28.95	2SC3180	3.37	2SC3317	1.81
2SC3011*	0.15	2SC3181	2.39	2SC3318	4.89
2SC3013*	0.81	2SC3182	2.38	2SC3320	4.89
2SC3014*	0.81	2SC3182N	2.38	2SC3322	6.59
2SC3015*	0.81	2SC3183	0.79	2SC3323*	2.03
2SC3016*	0.15	2SC3186	0.50	2SC3325*	2.03
2SC3018	24.20	2SC3187	1.79	2SC3326*	2.03
2SC3020	24.20	2SC3189	1.05	2SC3327	0.29
2SC3023	3.75	2SC3190	0.28	2SC3328	0.69
2SC3025	3.33	2SC3192	0.06	2SC3329	0.19
2SC3037	0.35	2SC3193	0.06	2SC3330	0.06
2SC3038	0.90	2SC3194	0.28	2SC3331	0.17
2SC3039	1.79	2SC3195	0.06	2SC3332	0.32
2SC3040	3.32	2SC3196	0.28	2SC3333	0.05
2SC3042	1.66	2SC3197	0.10	2SC3334	0.40
2SC3052*	0.08	2SC3198	0.19	2SC3336	17.95
2SC3053*	0.14	2SC3199	0.06	2SC3337	0.35
2SC3055	1.06	2SC32	2.73	2SC3345	1.12
2SC3056	1.05	2SC3200	0.72	2SC3352	1.18
2SC3057	1.05	2SC3201	0.20	2SC3353	1.18
2SC3068	0.30	2SC3202	0.97	2SC3354	0.11
2SC3069	0.19	2SC3203	0.08	2SC3355	0.35
2SC3072	1.94	2SC3205	0.19	2SC3356*	0.81
2SC3073	1.94	2SC3206	0.65	2SC3359	0.19
2SC3074	0.77	2SC3207	0.86	2SC3361*	0.08
2SC3076	0.77	2SC3208	3.45	2SC3364	2.29
2SC3080	1.20	2SC3209	0.99	2SC3365	7.99
2SC3081	0.54	2SC3210	6.09	2SC3366	0.84

Order #	(1-9)	Order #	(1-9)	Order #	(1-9)	Order #	(1-9)	Order #	(1-9)	Order #	(1-9)
2SC3367	\$0.78	2SC3583*	\$0.81	2SC3755	\$3.09	2SC3915*	\$2.03	2SC4077	\$0.08	2SC4271	\$0.68
2SC3374*	2.61	2SC3585*	0.15	2SC3756	3.09	2SC3920	0.22	2SC4078	0.66	2SC4273	1.28
2SC3375	0.22	2SC3589	2.50	2SC3757*	2.03	2SC3921	0.22	2SC4081*	0.20	2SC4274	6.60
2SC3376	5.25	2SC3590	1.06	2SC3777	0.35	2SC3922	0.22	2SC4082*	0.20	2SC4275	4.89
2SC3378	0.20	2SC3596	2.04	2SC3774*	0.81	2SC3923	0.22	2SC4083*	0.20	2SC4276	4.89
2SC3382	0.19	2SC3597	2.04	2SC3776	0.67	2SC3928*	0.08	2SC4084*	0.20	2SC4278	6.49
2SC3387	3.12	2SC3598	3.35	2SC3777	0.67	2SC3929*	0.20	2SC4097*	0.20	2SC4291	4.25
2SC3389	0.24	2SC3600	1.25	2SC3778	0.35	2SC3930*	0.20	2SC4098*	0.20	2SC4292	4.25
2SC3392*	2.03	2SC3601	0.24	2SC3779	0.35	2SC3931*	0.20	2SC4099*	0.20	2SC4294	4.25
2SC3395*	2.03	2SC3605	0.35	2SC3782	2.29	2SC3932*	0.20	2SC4100*	0.20	2SC4299	9.49
2SC3396*	2.24	2SC3606*	0.81	2SC3783	5.25	2SC3933*	0.20	2SC4103*	0.20	2SC4300	9.49
2SC3397*	2.03	2SC3611	1.62	2SC3785	2.13	2SC3934*	0.20	2SC4105	7.99	2SC4301	9.49
2SC3398*	2.03	2SC3613	0.68	2SC3786	1.12	2SC3935*	0.20	2SC4106	1.08	2SC4302	9.49
2SC3399	0.09	2SC3615	0.29	2SC3787	0.54	2SC3936*	0.20	2SC4108	1.66	2SC4304	5.69
2SC3401	0.09	2SC3619	2.19	2SC3788	0.29	2SC3937*	0.20	2SC4112*	2.03	2SC4305	0.63
2SC3409	6.59	2SC3622	0.19	2SC3789	0.36	2SC3938*	0.20	2SC4116*	2.27	2SC4312	9.59
2SC3415	1.79	2SC3622A	0.19	2SC3790	0.99	2SC394	0.35	2SC4120*	2.03	2SC4313	9.59
2SC3416	0.37	2SC3623	0.17	2SC3792	0.22	2SC3940	0.29	2SC4122	2.68	2SC4316	1.43
2SC3417	0.46	2SC3624*	2.03	2SC3793*	0.81	2SC3942	2.77	2SC4123	4.05	2SC4326*	0.15
2SC3419	1.98	2SC3625	1.05	2SC3794	5.69	2SC3943	0.89	2SC4124	10.20	2SC4326LK*	0.24
2SC3421	1.44	2SC3626	5.09	2SC3796	9.59	2SC3944	0.89	2SC4125	10.20	2SC4328	1.13
2SC3423	1.01	2SC3636	9.49	2SC3797	9.49	2SC3945	2.77	2SC4130	1.27	2SC4329	0.84
2SC3424	2.15	2SC3637	14.95	2SC3798	9.49	2SC3946	2.77	2SC4135	0.92	2SC4330	1.05
2SC3426*	2.03	2SC3638	32.95	2SC3800	0.06	2SC3950	0.68	2SC4137	1.05	2SC4360*	2.03
2SC3429*	0.81	2SC3642	9.49	2SC3802*	0.58	2SC3951	0.54	2SC4138	2.02	2SC4362*	2.03
2SC3430	4.03	2SC3643	9.49	2SC3802K*	0.24	2SC3952	0.54	2SC4139	17.95	2SC4366*	2.03
2SC3431	4.03	2SC3645	0.39	2SC3807	0.44	2SC3953	1.20	2SC4140	7.99	2SC4368	2.29
2SC3432	4.03	2SC3646*	0.38	2SC3808	1.66	2SC3954	1.62	2SC4142	7.29	2SC4369	2.00
2SC3433	4.03	2SC3647*	0.38	2SC380TM	0.06	2SC3955	1.09	2SC4143	7.29	2SC4373*	0.38
2SC3437*	0.08	2SC3651*	0.38	2SC381	0.35	2SC3956	0.66	2SC4144	2.63	2SC4375*	0.99
2SC3440*	0.15	2SC3653	0.19	2SC382	0.28	2SC3958	1.13	2SC4146*	2.03	2SC4376*	3.13
2SC3442	0.08	2SC3654	0.19	2SC3823	0.78	2SC3959	1.13	2SC4148	2.40	2SC4378	0.66
2SC3444*	0.38	2SC3655	0.15	2SC3826	1.25	2SC3960	1.13	2SC4153	1.28	2SC4381	0.88
2SC3445*	0.81	2SC3656	0.19	2SC3827*	0.58	2SC3961	1.81	2SC4155*	0.20	2SC4382	3.21
2SC3446	5.69	2SC3657	6.59	2SC3829*	0.81	2SC3962	1.81	2SC4158	1.52	2SC4386	2.53
2SC3449	9.59	2SC3658	3.33	2SC382TM	0.28	2SC3964	0.29	2SC4159	0.67	2SC4387	6.19
2SC3451	5.89	2SC3659	8.99	2SC383	0.32	2SC3968	1.06	2SC4160	0.90	2SC4388	7.99
2SC3456	2.48	2SC366	0.19	2SC3832	0.50	2SC3970	5.69	2SC4161	1.15	2SC4410*	0.20
2SC3457	2.48	2SC3663*	0.14	2SC3834	2.68	2SC3971	1.18	2SC4163	3.79	2SC4417*	0.20
2SC3458	9.59	2SC3665	0.31	2SC3835	4.65	2SC3972	1.18	2SC4168*	2.03	2SC4418	1.66
2SC3460	3.67	2SC3666	1.86	2SC3837*	0.14	2SC3977	5.69	2SC4169	0.23	2SC4423	3.95
2SC3461	5.72	2SC3667	0.78	2SC3837K*	0.24	2SC3978	5.69	2SC4170*	0.27	2SC4424	2.14
2SC3466	32.95	2SC367	0.06	2SC3838*	0.81	2SC3981	4.59	2SC4178*	0.20	2SC4431	1.86
2SC3467	0.45	2SC3670	1.86	2SC3838K*	0.24	2SC3983	0.19	2SC4179*	0.20	2SC4440	6.89
2SC3468	0.24	2SC3673	1.86	2SC3839*	0.14	2SC3985	0.44	2SC4182*	0.20	2SC4441	2.77
2SC3474	1.94	2SC3675	0.65	2SC3839K*	0.24	2SC3986	0.44	2SC4183*	0.20	2SC4444*	0.24
2SC3475	1.98	2SC3678	6.59	2SC383TM	0.32	2SC3987	0.76	2SC4184*	0.20	2SC4449	1.79
2SC3478	0.19	2SC3679	6.59	2SC3841*	0.15	2SC3992	18.99	2SC4185*	0.20	2SC4451	6.39
2SC3479	7.89	2SC3680	9.49	2SC3848*	0.15	2SC3993	18.99	2SC4186*	0.20	2SC4455	0.22
2SC3480	7.89	2SC3681	2.87	2SC3851	0.83	2SC3995	16.57	2SC4187*	0.20	2SC4457	5.49
2SC3481	4.25	2SC3682	8.79	2SC3851A	4.19	2SC3997	18.99	2SC4188	0.75	2SC4458	5.69
2SC3482	2.87	2SC3683	8.79	2SC3852	0.76	2SC3998	18.99	2SC4193	1.81	2SC4459	7.29
2SC3483	5.49	2SC3684	8.79	2SC3852A	4.19	2SC3999	1.79	2SC4194	1.79	2SC4460	7.29
2SC											

Order #	(1-9)	Order #	(1-9)	Order #	(1-9)	Order #	(1-9)	Order #	(1-9)	Order #	(1-9)
2SC4648	\$0.44	2SC5395	\$0.60	2SC840	\$3.33	2SD1109	\$2.34	2SD125	\$2.37	2SD1437	\$2.40
2SC4663	1.14	2SC5404	1.90	2SC853	1.88	2SD1111	8.69	2SD125A	2.37	2SD1439LB	3.06
2SC4664	3.75	2SC5407	7.92	2SC858	0.06	2SD1110	1.85	2SD125AH	2.37	2SD1440	3.06
2SC4686A	2.84	2SC5411	3.75	2SC870	0.13	2SD1113	1.98	2SD1263	2.77	2SD1442	0.98
2SC4688	1.60	2SC5426	13.49	2SC871	0.13	2SD1114	1.06	2SD1264	0.69	2SD1442A	2.40
2SC4689	2.70	2SC5440	10.00	2SC882	10.95	2SD1115	1.06	2SD1264A	0.69	2SD1443	1.12
2SC4696	0.67	2SC5443	7.29	2SC883	0.92	2SD1115K	1.06	2SD1265A	1.92	2SD1443A	0.93
2SC4742	4.39	2SC5453	7.69	2SC895	5.29	2SD1116	1.06	2SD1266A	1.92	2SD1444	2.40
2SC4743	9.49	2SC5552	7.92	2SC897	5.29	2SD1121	1.06	2SD1267	0.57	2SD1445A	1.92
2SC4746	8.09	2SC5570	11.20	2SC898	5.29	2SD1124	3.12	2SD1267A	1.92	2SD1450	0.19
2SC4747	8.09	2SC5584	6.69	2SC899	0.32	2SD1126	1.05	2SD1268	3.55	2SD1451	7.89
2SC4762	9.95	2SC5587	5.02	2SC901	10.79	2SD1126K	1.05	2SD1269	3.55	2SD1452	1.60
2SC4763	3.91	2SC5588	12.19	2SC922	0.35	2SD1127	1.05	2SD1270	0.92	2SD1454	3.12
2SC4769	5.49	2SC5622	2.99	2SC923	0.65	2SD1127K	1.05	2SD1271	2.77	2SD1455	3.12
2SC4770	2.13	2SC5681	3.52	2SC924	1.56	2SD1128	1.13	2SD1272	0.92	2SD1459	1.13
2SC4779S	0.26	2SC5682	4.39	2SC925	1.26	2SD1131	3.32	2SD1273	0.75	2SD1461	3.75
2SC478	0.10	2SC5716	6.99	2SC929	0.08	2SD1132	0.39	2SD1273A	1.92	2SD1469	0.66
2SC4783*	1.59	2SC5778	3.99	2SC930	0.08	2SD1134	3.32	2SD1274	0.92	2SD1475	0.74
2SC4789	18.99	2SC5803	2.38	2SC930NP	0.08	2SD1135	0.57	2SD1275	2.53	2SD1476	0.79
2SC479	2.06	2SC5855	2.69	2SC931	2.27	2SD1136	1.92	2SD1275A	1.92	2SD1477	0.96
2SC4793	1.09	2SC5858	8.59	2SC932	2.27	2SD1137	0.57	2SD1276	0.57	2SD1478*	2.21
2SC480	1.72	2SC5859	12.83	2SC933	0.27	2SD1138	0.75	2SD1288	2.34	2SD1479	1.50
2SC4820	2.56	2SC603	0.08	2SC934	0.30	2SD1139	0.75	2SD1290	3.06	2SD1480	2.40
2SC4831	12.59	2SC632	0.19	2SC937	3.38	2SD114	8.19	2SD1291	1.50	2SD1481	0.82
2SC4833	1.33	2SC633	0.19	2SC938	1.48	2SD1141	1.06	2SD1294	4.69	2SD1482*	2.03
2SC4834	2.39	2SC634	0.35	2SC939	5.29	2SD1142	3.33	2SD130	3.33	2SD1485	1.61
2SC485	4.28	2SC639	0.48	2SC940	10.79	2SD1143	3.33	2SD1300	3.75	2SD1486	2.21
2SC4883	2.84	2SC641	0.06	2SC941	0.28	2SD1146	0.23	2SD1303	0.21	2SD1487	4.99
2SC4883A	0.70	2SC641K	0.06	2SC941TM	0.28	2SD1147	0.78	2SD1304*	0.81	2SD1489	0.24
2SC4886	2.96	2SC642	3.38	2SC943	1.26	2SD1148	2.61	2SD1306*	2.03	2SD1492	5.49
2SC4890	7.29	2SC643	3.38	2SC944	0.97	2SD1150	0.80	2SD1307	0.80	2SD1493	1.60
2SC4891	7.29	2SC644	0.35	2SC944S	0.97	2SD1152	0.39	2SD1309	0.63	2SD1494	1.60
2SC492	8.69	2SC646	0.92	2SC945	0.08	2SD1157	0.79	2SD131	2.37	2SD1495	3.12
2SC4923	3.28	2SC647	4.10	2SC945L	0.08	2SD116	4.09	2SD1311	0.63	2SD1497	4.48
2SC4924	8.19	2SC650	0.06	2SC949	0.15	2SD1160	0.77	2SD1312	1.56	2SD1499	0.75
2SC4927	10.59	2SC664	2.37	2SC950	0.08	2SD1161*	0.14	2SD1314	5.79	2SD1500	1.05
2SC493	5.29	2SC665	5.29	2SC951	0.09	2SD1163A	0.80	2SD1315	0.92	2SD1503	2.80
2SC494	2.37	2SC668	0.08	2SC952	0.72	2SD1170	2.93	2SD1322	0.74	2SD1505	2.40
2SC496	1.13	2SC669	1.88	2SC961	10.95	2SD1171	3.33	2SD1325	0.42	2SD1508	0.82
2SC5021*	2.13	2SC669A	4.89	2SC962	2.37	2SD1172	8.99	2SD1326	0.57	2SD151	2.37
2SC504	2.73	2SC674	1.60	2SC966	0.19	2SD1173	8.99	2SD1331	1.39	2SD1510	0.57
2SC5048	5.99	2SC678	2.37	2SC967	0.19	2SD1174	8.99	2SD1332	3.12	2SD1511*	0.38
2SC509	0.08	2SC681	10.79	2SC968	0.19	2SD1175	8.99	2SD1333	3.12	2SD1513	0.24
2SC5100	2.42	2SC684	0.14	2SC980	0.19	2SD1176A	2.53	2SD1334	3.12	2SD1516	1.13
2SC5101	3.79	2SC693	0.28	2SC980A	0.60	2SD118	6.29	2SD1335	3.12	2SD1517	3.55
2SC5124	6.75	2SC694	0.28	2SC980AG	0.60	2SD1184	3.75	2SD1336	2.77	2SD1521	0.64
2SC5143	5.89	2SC709	0.15	2SC982	0.65	2SD1185	14.95	2SD1339	3.75	2SD1525	9.54
2SC5144	11.97	2SC710	0.13	2SC982TM	0.65	2SD1186	3.33	2SD1341	4.10	2SD1528	1.13
2SC5147	0.67	2SC712	0.15	2SC983	0.19	2SD1187	2.61	2SD1342	3.38	2SD1531	0.50
2SC5148	4.49	2SC712A	0.15	2SC984	0.52	2SD119	6.29	2SD1343	3.38	2SD1532	2.68
2SC5149	4.19	2SC713	0.15	2SC994	2.73	2SD1192	2.66	2SD1344	3.38	2SD1533	1.79
2SC515	5.39	2SC715	0.35	2SC999A	3.75	2SD1193	5.89	2SD1345	0.98	2SD1536	0.30
2SC5150	5.65	2SC722	1.60	2SD1000*	1.67	2SD1194	0.78	2SD1347	0.45	2SD1537	0.73
2SC5169	1.39	2SC723	1.43	2SD1001*	1.67	2SD1195	0.78	2SD1349	9.48	2SD1539	2.40
2SC5171	1.45	2SC724	1.48	2SD1004*	0.38	2SD1196	2.66	2SD1351	0.73	2SD1539A	1.92
2SC5174	0.59	2SC725	1.48	2SD1005*	0.38	2SD1198	0.72	2SD1352	0.79	2SD1540	2.37
2SC518	3.43	2SC727	0.47	2SD1010	1.11	2SD1199	0.53	2SD1372	1.06	2SD1542	3.29
2SC519	8.69	2SC730	1.77	2SD1011	1.48	2SD1205	0.53	2SD1373	3.32	2SD1543	3.29
2SC5196	3.20	2SC732	0.19	2SD1012	0.97	2SD1206	0.96	2SD1377	2.24	2SD1544	3.29
2SC5197	3.13	2SC732TM	0.19	2SD1016	3.38	2SD1207	0.23	2SD1377K	2.24	2SD1545	3.29
2SC5198	3.39	2SC733	1.11	2SD1022	1.44	2SD1208	0.92	2SD1378	1.88	2SD1546	5.93
2SC519A	8.69	2SC734	0.08	2SD1023	1.25	2SD1209	0.39	2SD1380	0.39	2SD1548	14.95
2SC520	2.37	2SC735	0.19	2SD1024	1.05	2SD1209K	1.88	2SD1383*	0.39	2SD1549	4.36
2SC5200	3.99	2SC736	4.09	2SD1025	1.05	2SD1215	0.39	2SD1386	1.05	2SD1551	3.29
2SC5207	3.50	2SC738	0.13	2SD1029	0.98	2SD1217	0.39	2SD1387	0.24	2SD1552	3.29
2SC520A	2.37	2SC752	0.28	2SD1030*	2.03	2SD1218	2.53	2SD1388	1.88	2SD1553	3.29
2SC521	2.37	2SC752GT	0.97	2SD1031	2.68	2SD1220	1.01	2SD1391	2.16	2SD1554	1.44
2SC521A	4.09	2SC756	8.90	2SD1032	3.12	2SD1221	0.77	2SD1392	0.63	2SD1555	2.88
2SC5229	0.52	2SC760	4.09	2SD1035	0.84	2SD1222	0.77	2SD1393	1.43	2SD1556	3.45
2SC5242	4.99	2SC765	0.92	2SD1046	3.79	2SD1223	1.94	2SD1394	1.43	2SD1557	5.73
2SC5243	5.41	2SC766	4.09	2SD1047	3.79	2SD1224	0.77	2SD1397	1.70	2SD1558	0.39
2SC5248	0.86	2SC768	4.09	2SD1049	3.43	2SD1225M	0.30	2SD1398	2.97	2SD1559	5.69
2SC5250	2.47	2SC769	10.95	2SD1051	1.91	2SD1226	2.12	2SD1400	4.25	2SD1562	0.78
2SC5271	1.07	2SC780	0.19	2SD1052	3.52	2SD1228	2.12	2SD1401	4.25	2SD1562A	1.39
2SC5296	1.39	2SC780A	0.71	2SD1052A	0.73	2SD1229	1.63	2SD1402	4.25	2SD1563A	0.39
2SC5297	2.23	2SC780AG	0.71	2SD1055	1.86	2SD1230	1.63	2SD1403	4.25	2SD1565	1.44
2SC5298	3.14	2SC784	1.79	2SD1059	1.11	2SD1231	2.37	2SD1407	0.87	2SD1566	4.03
2SC5299	2.08	2SC789	1.11	2SD1060	0.80	2SD1232	2.37	2SD1408	1.10	2SD1567	0.73
2SC5301	7.95	2SC790	0.60	2SD1061	2.40	2SD1233	8.09	2SD1409	1.39	2SD1568	0.57
2SC5302	1.90	2SC792	2.57	2SD1062	1.12	2SD1235	0.93	2SD1413	1.98	2SD1569	0.59
2SC5331	8.73	2SC793	5.29	2SD1063	4.89	2SD1236	0.78	2SD1414	1.98	2SD1571	5.69
2SC5339	2.71	2SC794	4.09	2SD1064	4.89	2SD1236L	1.35	2SD1415	1.98	2SD1572	1.12
2SC535	0.12	2SC805	3.22	2SD1065	4.89	2SD1237	3.55	2SD1416	1.98	2SD1576	3.10
2SC5358	3.71	2SC807	9.95	2SD1069	2.50	2SD1237L	1.35	2SD1425	1.58	2SD1580	2.40
2SC5359	4.38	2SC814	0.19	2SD107	2.37	2SD1238	3.79	2SD1426	1.58	2SD1581	0.37
2SC536	0.06	2SC815	1.48	2SD1071	1.16	2SD124	6.29	2SD1427	2.10	2SD1582	0.17
2SC536KN	0.09	2SC828	0.24	2SD1072	0.27	2SD1242	4.23	2SD1428	4.39	2SD1585	0.49
2SC537	0.06	2SC828A	0.15	2SD108	2.37	2SD1243	4.99	2SD1429	5.49	2SD1586	0.34
2SC538	0.19	2SC829	0.24	2SD1085	1.06	2SD1246	0.25	2SD1430	5.49	2SD1591	1.30
2SC5386	4.79	2SC830	3.33	2SD1089	0.80	2SD1248K	2.24	2SD1431	2.10	2SD1593	0.34
2SC5387	5.99	2SC836	0.35	2SD1090	6.19	2SD124A	2.37	2SD1432	4.39	2SD1595	0.34
		2SC837	0.35	2SD110	8.69	2SD124AH	2.37	2SD1435	5.69	2SD1599	2.66
		2SC838	0.15	2SD1101*	2.03			2SD1436	5.69	2SD16	2.37

Order #	(1-9)	Order #	(1-9)	Order #	(1-9)
2SD1600	\$2.66	2SD177	\$8.69	2SD1940	\$0.76
2SD1601	0.39	2SD1770	0.61	2SD1941	7.29
2SD1602	2.66	2SD1770A	0.52	2SD1943	3.52
2SD1603	1.12	2SD1772	0.69	2SD1944	0.80
2SD1604	2.66	2SD1772A	0.82	2SD1950*	0.27
2SD1605	0.78	2SD1774A	3.52	2SD1951	0.24
2SD1606	0.78	2SD1776A	1.92	2SD1955	

Order #	(1-9)	Order #	(1-9)	Order #	(1-9)
2SD2254	\$4.19	2SD325	\$0.38	2SD522	\$5.29
2SD2259	0.58	2SD327	0.06	2SD523	2.37
2SD226	3.33	2SD330	0.73	2SD524	2.37
2SD227	0.19	2SD331	0.73	2SD525	1.44
2SD2273	4.19	2SD332	8.59	2SD526	0.79
2SD2274	4.19	2SD334	8.69	2SD53	4.09
2SD2275	4.19	2SD334A	8.69	2SD531	1.11
2SD2276	4.19	2SD335	8.19	2SD536	10.79
2SD2288	3.75	2SD338	2.37	2SD537	10.79
2SD2292	3.38	2SD339	8.19	2SD544	1.11
2SD2294	3.29	2SD340	5.29	2SD545	0.09
2SD2296	3.29	2SD341	5.29	2SD549	1.13
2SD2298	3.29	2SD341H	2.37	2SD551	5.29
2SD231	8.19	2SD342	3.01	2SD552	14.95
2SD2331	3.85	2SD344	3.01	2SD553	3.55
2SD2333	3.80	2SD346	1.68	2SD555	10.79
2SD234	0.73	2SD348	3.38	2SD556	5.29
2SD2342	7.29	2SD349*	0.58	2SD557	5.29
2SD2348	7.20	2SD350	3.75	2SD558	4.14
2SD2349	7.19	2SD350A	3.75	2SD560	0.78
2SD234G	0.82	2SD353	8.09	2SD568	1.35
2SD235	0.73	2SD365	0.82	2SD569	1.35
2SD2353	2.03	2SD365A	2.27	2SD570	3.01
2SD2356	0.73	2SD369	0.92	2SD5703	2.89
2SD236	3.33	2SD371	4.09	2SD571	0.30
2SD2374	2.03	2SD379	2.37	2SD575	3.75
2SD2375	2.03	2SD380	3.33	2SD577	3.75
2SD2386	3.99	2SD380A	3.33	2SD582	5.29
2SD2387	3.99	2SD381	0.58	2SD589	3.33
2SD2389	5.01	2SD382	0.61	2SD59	2.37
2SD2390	4.99	2SD386	0.61	2SD591	0.35
2SD2394	0.60	2SD386A	0.61	2SD592	0.09
2SD2395	0.92	2SD387	0.61	2SD592A	1.88
2SD2396	0.92	2SD387A	0.61	2SD597	2.37
2SD24	1.56	2SD388	5.29	2SD598	8.69
2SD2401	19.16	2SD389A	3.01	2SD600	0.48
2SD2438	5.73	2SD400	0.23	2SD600K	1.88
2SD2439	8.41	2SD401	0.52	2SD601*	0.58
2SD2449	3.88	2SD402	0.61	2SD601A*	2.03
2SD246	3.75	2SD402A	0.61	2SD602*	2.03
2SD247	2.37	2SD404	0.98	2SD602A*	2.03
2SD2488	5.99	2SD41	10.79	2SD603	3.37
2SD249	8.19	2SD411	6.49	2SD608	1.23
2SD2490	7.99	2SD414	0.37	2SD610	2.50
2SD2493	1.63	2SD415	0.37	2SD612	0.39
2SD2494	2.14	2SD424	5.29	2SD612K	0.43
2SD2495	4.19	2SD425	5.29	2SD613	1.11
2SD2498	1.27	2SD426	5.29	2SD617	6.49
2SD2499	3.29	2SD427	6.29	2SD619	0.44
2SD2500	2.59	2SD428	5.29	2SD627	3.38
2SD2525	2.68	2SD430	10.95	2SD628	6.49
2SD2539	4.09	2SD431	10.95	2SD628H	6.49
2SD2553	5.89	2SD432	10.95	2SD629	6.49
2SD2560	4.25	2SD438	0.47	2SD629H	6.49
2SD257	3.33	2SD439	0.39	2SD632	4.34
2SD2578	3.45	2SD46	5.29	2SD633	1.35
2SD2580	2.62	2SD460	1.05	2SD634	2.53
2SD2586	4.49	2SD463	2.37	2SD636	0.96
2SD2589	2.49	2SD464	6.49	2SD637	0.25
2SD259	3.32	2SD467	0.08	2SD649	3.75
2SD2599	9.59	2SD468	0.13	2SD650	4.34
2SD260	2.37	2SD47	2.37	2SD655	0.38
2SD261	1.88	2SD471	0.13	2SD658	3.33
2SD2627	2.99	2SD471A	0.13	2SD661	1.11
2SD2634	2.49	2SD473	2.37	2SD662	0.84
2SD2638	2.39	2SD473H	2.37	2SD665	14.95
2SD2645	3.06	2SD475	2.27	2SD666	0.39
2SD2645-YB	2.16	2SD476	0.80	2SD666A	0.39
2SD287	6.29	2SD476A	3.01	2SD667	0.39
2SD288	0.99	2SD476AK	3.01	2SD667A	0.39
2SD299	3.75	2SD476K	3.01	2SD668	0.98
2SD300	3.75	2SD478	0.75	2SD668A	0.98
2SD301	2.37	2SD492	2.37	2SD669	0.64
2SD313	0.82	2SD50	2.37	2SD669A	0.64
2SD314	0.80	2SD502	3.19	2SD67	8.69
2SD315	3.33	2SD503	2.37	2SD670	2.37
2SD316	2.37	2SD504	6.49	2SD670H	2.37
2SD317	0.80	2SD505	5.29	2SD671	0.07
2SD317A	3.01	2SD506	2.37	2SD673	5.29
2SD318	0.80	2SD51	2.37	2SD673A	8.59
2SD319	5.29	2SD51A	3.75	2SD674	10.95
2SD322	6.29	2SD52	2.37	2SD674A	8.59

Order #	(1-9)	Order #	(1-9)	Order #	(1-9)	Order #	(1-9)	Order #	(1-9)	Order #	(1-9)
2SD675	\$5.29	2SD845	\$10.95	2SD946A	\$0.21	2SK2134	\$0.49	4015	\$3.37	6N137	\$9.95
2SD676	5.29	2SD847	3.43	2SD947	0.89	2SK214	2.41	4016	0.70	6NX6	10.25
2SD677	8.69	2SD849	3.75	2SD950	4.10	2SK2141	7.89	4017	1.37	7.5V 1/2W	0.19
2SD678	0.82	2SD850	7.29	2SD951	8.99	2SK2148	6.88	4020	3.57	7.5V 1W	0.29
2SD678A	2.53	2SD855	0.82	2SD952	8.99	2SK215	8.59	4021	1.26	7.5V 400MW	0.79
2SD679	2.53	2SD855A	0.79	2SD953	8.99	2SK216	3.35	4023	0.93	7400	0.91
2SD679A	0.57	2SD856	0.73	2SD956	8.99	2SK2201	0.41	4024	2.98	7402	0.93
2SD68	2.37	2SD856A	3.55	2SD957	3.38	2SK2221	9.79	4025	0.68	7403	0.86
2SD687	0.82	2SD856B	0.57	2SD957A	3.38	2SK2255-01MR		4026	2.69	7404	1.14
2SD689	3.32	2SD857	0.39	2SD958	1.48		3.69	4027	1.51	7405	0.87
2SD69	4.09	2SD857A	3.55	2SD959	3.55	2SK2382	4.89	4028	1.34	7406	1.05
2SD692	2.37	2SD857B	0.57	2SD960	3.55	2SK241	0.81	4029	3.71	7407	1.25
2SD712	1.11	2SD858	1.65	2SD961	0.84	2SK246	0.39	4030	1.26	7408	0.87
2SD716	1.99	2SD858A	3.12	2SD965	0.50	2SK2543	1.63	4035	3.34	7409	0.86
2SD717	2.55	2SD858B	3.12	2SD967	0.21	2SK2564	4.34	4040	1.86	7410	0.86
2SD718	1.69	2SD859	0.80	2SD968*	1.88	2SK2638	1.79	4042	2.44	7411	1.69
2SD721	2.53	2SD859A	1.06	2SD968A*	0.38	2SK2642	4.29	4044	2.47	7412	1.94
2SD722	2.68	2SD859B	2.71	2SD969	0.45	2SK2645	3.84	4046	4.96	7413	0.90
2SD723	0.57	2SD860	0.80	2SD970	1.05	2SK2662	3.29	4050	0.82	7414	3.51
2SD724	1.92	2SD860A	1.06	2SD970K	2.24	2SK2674	13.69	4052	1.01	7416	1.38
2SD725	3.38	2SD860B	2.71	2SD971	0.50	2SK2717	1.05	4053	1.51	7417	1.27
2SD726	1.11	2SD861	0.80	2SD972	0.80	2SK2718	3.31	4060	1.25	7425	0.86
2SD727	3.12	2SD861A	1.06	2SD973A	0.72	2SK2723	1.14	4066	0.63	7426	0.86
2SD728	4.99	2SD862	0.20	2SD974	0.39	2SK2771	4.62	4069	0.61	7427	0.86
2SD729	2.37	2SD864	0.78	2SD976	1.05	2SK2837	11.95	4070	0.71	7432	2.21
2SD729H	2.37	2SD864K	0.78	2SD976A	1.06	2SK2847	1.95	4071	0.67	7433	1.05
2SD73	2.37	2SD866	2.40	2SD978	2.71	2SK2872	2.89	4081	0.59	7437	0.90
2SD732	5.29	2SD866A	0.84	2SD979	1.66	2SK2876	2.80	4082	0.95	7438	1.51
2SD733	5.29	2SD867	6.29	2SD980	1.66	2SK2937	1.41	4093	0.78	7442	1.73
2SD734	0.14	2SD868	8.99	2SD981	10.79	2SK30	0.79	4510	0.92	7445	2.95
2SD743	1.11	2SD869	3.75	2SD982	1.25	2SK304	1.09	4511	1.52	7447	3.61
2SD743A	0.57	2SD870	4.10	2SD983	0.84	2SK3053	1.09	4514	2.00	7450	0.86
2SD748	10.79	2SD871	3.38	2SD985	0.20	2SK30A	0.79	4516	3.09	7454	0.95
2SD750	5.29	2SD873	14.95	2SD987	1.12	2SK3324	3.99	4518	0.92	7470	1.01
2SD751	4.99	2SD874A*	1.67	2SD990	0.57	2SK3326	4.66	4520	1.46	7472	2.40
2SD755	0.39	2SD875*	1.67	2SD991	1.06	2SK34	7.89	4522	4.53	7473	4.70
2SD756	0.26	2SD876	1.92	2SD991K	1.06	2SK34E	1.12	4526	2.73	7474	1.79
2SD756A	1.08	2SD878	2.37	2SD993	8.99	2SK3505	6.86	4527	3.75	7476	5.15
2SD759	1.23	2SD879	0.24	2SD998	2.46	2SK363	0.43	4528	1.12	7485	3.98
2SD760	0.52	2SD88	2.37	2SD999*	1.67	2SK364	0.26	4529	2.95	7489	11.95
2SD762	0.82	2SD880	0.59	2SJ103	0.26	2SK369	0.54	4538	2.07	7490	1.56
2SD762A	0.79	2SD882	0.20	2SJ161	12.63	2SK373	0.79	4541	1.01	7491	1.76
2SD763	0.47	2SD884	1.06	2SJ162	9.69	2SK386	9.34	4558	0.56	7492	2.33
2SD765	3.75	2SD885	1.06	2SJ175	1.86	2SK40	1.66	40106B	1.46	7493	2.00
2SD767	0.09	2SD886	3.52	2SJ201	9.89	2SK405	8.99	4030B	1.26	7495	2.59
2SD768K	0.78	2SD886A	3.52	2SJ352	8.09	2SK41	1.12	403CNQ100	52.99	7805	0.87
2SD769	4.09	2SD889	0.08	2SJ449	7.25	2SK413	8.99	4043B	2.38	7806	1.04
2SD770	0.22	2SD88A	2.37	2SJ512	2.52	2SK44	0.93	4049UB	0.69	7808	1.22
2SD771	1.43	2SD890	0.80	2SJ74	1.24	2SK49	1.66	4053BCN	1.51	7809	1.67
2SD772	1.92	2SD891	0.30	2SJ77	4.41	2SK511	3.86	43V 1/2W	0.19	7810	1.74
2SD772A	1.25	2SD891A	1.86	2SJ78	3.31	2SK538	6.69	43V 1W	0.29	7812	1.22
2SD773	0.37	2SD892	1.86	2SK1030	6.26	2SK55	0.43	4502B	2.09	7815	1.22
2SD774	0.17	2SD892A	0.19	2SK104	1.15	2SK553	3.84	4510B	0.92	7818	1.22
2SD777	0.92	2SD893	0.09	2SK104E	1.15	2SK68	1.89	4512B	2.80	7824	1.22
2SD778	0.96	2SD893A	1.88	2SK105	1.10	2SK68A	1.89	4515B	6.69	7905	0.86
2SD779	0.53	2SD895	1.65	2SK1057	9.54	2SK725	12.95	4521B	2.08	7906	1.22
2SD780*	2.03	2SD896	1.52	2SK1058	9.99	2SK790	12.95	4556B	1.84	7908	1.22
2SD782	2.50	2SD897	3.75	2SK107	1.66	2SK792	3.31				

New semiconductors are printed in purple.

Order #	(1-9)	Order #	(1-9)	Order #	(1-9)	Order #	(1-9)	Order #	(1-9)	Order #	(1-9)
74393	\$2.88	74HC237	\$3.79	74HCT174	\$0.84	74LS109	\$0.90	74LS161	\$1.14	74LS245	\$1.61
75188	1.04	74HC244	2.27	74HCT240	1.35	74LS111	0.73	74LS162	2.52	74LS247	2.22
75189	1.04	74HC245	0.68	74HCT440	0.58	74LS112	0.82	74LS163	3.23	74LS248	2.66
74C221	7.89	74HC257	1.01	74HCT445	0.45	74LS113	0.89	74LS164	0.89	74LS249	2.22
74C244	3.41	74HC257D*	0.37	74HCT273	0.92	74LS114	0.89	74LS168	2.95	74LS251	1.05
74F04	0.55	74HC259	1.41	74HCT32	0.52	74LS12	1.31	74LS170	3.91	74LS253	2.70
74F08	0.34	74HC273	0.92	74HCT373	0.76	74LS122	1.30	74LS173	1.64	74LS257	3.75
74F244	0.97	74HC32	0.35	74HCT374	0.87	74LS123	1.14	74LS174	2.85	74LS258	2.41
74H04	1.43	74HC367	0.68	74HCT541	1.14	74LS125	1.33	74LS175	0.91	74LS259	1.45
74HC00	0.58	74HC393	1.24	74HCT574	1.04	74LS126	1.05	74LS181	4.42	74LS260	0.86
74HC02	1.75	74HC400	1.39	74HCT74	0.68	74LS13	3.26	74LS190	2.52	74LS266	0.99
74HC04	1.21	74HC4053	1.14	74HCT86	0.45	74LS132	2.03	74LS191	3.91	74LS27	1.00
74HC08	1.61	74HC4066	0.92	74LS00	0.35	74LS136	1.02	74LS192	2.76	74LS273	1.80
74HC10	1.50	74HC4538	1.17	74LS00N	0.35	74LS138	0.87	74LS193	1.10	74LS279	0.90
74HC123	0.81	74HC540	1.04	74LS01	1.00	74LS139	0.74	74LS194	1.21	74LS28	1.00
74HC125	0.95	74HC595	1.14	74LS02	0.65	74LS14	0.87	74LS196	2.66	74LS283	2.76
74HC132	0.92	74HC74	1.23	74LS03	1.00	74LS15	1.00	74LS197	1.93	74LS290	1.30
74HC138	2.31	74HC86	1.10	74LS04	0.45	74LS151	0.80	74LS20	0.50	74LS293	1.35
74HC14	0.59	74HCT04	0.45	74LS05	0.67	74LS153	2.41	74LS21	0.73	74LS295	1.86
74HC151	1.01	74HCT08	0.45	74LS06	2.12	74LS154	5.32	74LS22	1.00	74LS30	1.00
74HC153	0.81	74HCT138	0.46	74LS07	2.82	74LS155	2.41	74LS221	3.04	74LS32	0.82
74HC164	0.68	74HCT14	0.81	74LS08	0.50	74LS156	1.58	74LS240	1.82	74LS33	1.00
74HC174	0.42	74HCT157	0.53	74LS09	1.00	74LS157	0.83	74LS241	3.71	74LS352	1.83
74HC175	0.87	74HCT161	1.18	74LS10	0.51	74LS158	1.16	74LS243	3.38	74LS366	1.22
74HC221	2.31	74HCT163	1.18	74LS107	1.01	74LS160	2.14	74LS244	1.41	74LS367	0.75

Semiconductors/Components



section
16

Order #	(1-9)	Order #	(1-9)	Order #	(1-9)
74LS368	\$1.09	74LS629	\$4.89	78L15	\$1.22
74LS37	0.86	74LS670	4.26	78L18	1.22
74LS373	1.08	74LS73	1.18	78LR05	4.49
74LS374	1.75	74LS74	0.67	78M05	0.30
74LS377	4.99	74LS75	0.84	78MR05	1.95
74LS379	1.88	74LS76	1.09	79L05	1.22
74LS38	0.92	74LS78	1.07	79L12	1.22
74LS386	0.96	74LS83	2.58	79L15	2.08
74LS390	2.07	74LS85	2.91	8.2V 1W	0.29
74LS393	1.04	74LS86	0.65	8461-0538	7.59
74LS40	1.00	74LS90	1.77	9.1V 1/2W	0.19
74LS42	0.70	74LS93	1.04	9.1V 1W	0.29
74LS47	1.89	74S02	1.28	93C46N	2.19
74LS48	2.30	74S04	1.15	951X	22.29
74LS49	1.01	7805CT	1.99	953X	23.05
74LS51	1.00	7812UC	0.93		
74LS54	1.00	78L05	1.22		
74LS541	3.30	78L08	2.16		
74LS55	1.00	78L12	1.22		

Order #	(1-4)	(5-9)	(10-29)	Order #	(1-4)	(5-9)	(10-29)	Order #	(1-4)	(5-9)	(10-29)
M-1N4007	\$0.29	\$0.27	\$0.24	M-MOC3041	\$5.39	\$4.96	\$4.56	M-MPSA14	\$0.39	\$0.36	\$0.33
M-1N751A	0.13	0.12	0.11	M-MOC70T1	3.33	2.87	2.55	M-MPSA18	0.56	0.52	0.45
M-2N3772	3.27	2.89	2.58	M-MC78PC50NTR	0.38	-	-	M-MPSA20	0.32	0.29	0.26
M-2N3773	3.12	2.76	2.46	M-MC7905CT	0.92	0.82	0.71	M-MPSA42	0.11	0.10	0.09
M-2N3906	0.23	0.21	0.19	M-MC7915CT	0.72	0.65	0.57	M-MPSA56	0.24	0.23	0.19
M-2N5457	0.67	0.59	0.50	M-MJ11032	9.60	8.50	7.57	M-MPSU10	11.80	10.69	9.73
M-2N5462	0.45	0.42	0.37	M-MJ15015	2.14	1.82	1.37	M-MPSU95	34.92	32.72	30.12
M-2N5486	0.12	-	-	M-MJ2955	2.31	1.97	1.49	M-MRF476	3.11	2.70	2.34
M-2N6287	5.64	5.00	4.45	M-MJ802	4.10	3.63	3.22	M-MUR420	0.18	-	-
M-2N6488	1.16	1.04	0.91	M-MJE15030	0.87	0.79	0.70	M-MUR460	0.48	0.45	0.40
M-2N6490	1.10	1.07	1.03	M-MJE243	1.85	1.67	1.43	M-T2800D	1.05	0.95	0.83
M-2N6509	2.56	2.21	1.96	M-MOC3010	2.97	2.73	2.51	M-TIP102	0.89	0.81	0.71
M-IRF511	10.95	10.07	9.26	M-MOC3020	3.79	3.49	3.21	M-TIP127	1.01	0.92	0.80
M-IRF540	4.54	4.06	3.70	M-MOC3021	3.79	3.49	3.21	M-TIP122	0.86	0.78	0.68
M-LM311N	0.72	0.65	0.57	M-MOC3030	5.89	5.42	4.99	M-TIP147	2.58	2.32	2.00
M-LM337T	1.39	1.25	1.07	M-MOC3041	5.39	4.96	4.56	M-TIP32C	0.45	0.39	0.35
M-MOC3010	2.97	2.73	2.51	M-MPF102	0.50	0.45	0.40	M-TIP42C	0.84	0.77	0.67
M-MOC3020	3.79	3.49	3.21	M-MPSA05	0.24	0.23	0.19	M-TL084CN	1.53	1.34	1.14
M-MOC3021	3.79	3.49	3.21	M-MPSA06	0.29	0.27	0.24				
M-MOC3030	5.89	5.42	4.99	M-MPSA13	0.34	0.31	0.28				



ON Semiconductor

ON Semiconductor, formerly a division of Motorola, is the world's leading supplier of analog, logic, power and discrete semiconductor components. These power and interface products are an integral part of electronics that provide the security, convenience and entertainment in today's world. ON Semiconductors are manufactured to the highest quality and have the reliability that service technicians can depend on.

Note: To ensure that you receive original ON products, please specify M-before the part number.

ELENCO Basic Parts Kit

Contains: Resistors: 1/4W, five each, 10Ω, 100Ω, 470Ω, 1KΩ, 2.2KΩ, 4.7KΩ, 8.2KΩ, 10KΩ, 18KΩ, 27KΩ, 47KΩ, 82KΩ, 100KΩ, 220KΩ, 330KΩ, 470KΩ, 1MΩ.
Electrolytic Capacitors: 50V radial, two each, 1μF, 4.7μF, 10μF, 47μF, 100μF, 470μF, 1000μF.
Mylar Capacitors: 100V Radial DIP, two each, .001μF, .0047μF, .01μF, .047μF, .1μF, .33μF.
Ceramic Disc Capacitors: 500V, two each, 2.2pF, 4.7pF, 10pF, 1pF, 22pF, 47pF, 100pF, 220pF, 470pF, 680pF.
Inductors: One each, 4.7μH, 10μH, 47μH, 100μH, 470μH, 1mH, 10mH, 33mH.
Trimpots: Single turn, one each, 500Ω, 1KΩ, 5KΩ, 50KΩ, 100KΩ, 500KΩ, 1MΩ.
Switches: Two each, push-button, SPDT slide, DPDT slide, 8-position DIP.
LEDs: Standard T 1 1/8 size, 5 each, red, green, yellow.
Displays: Two each, 7-segment common cathode, 7-segment common anode.
Integrated Circuits: Two each, 7805, 7812 regulators, LM386 audio amp, 555 timer, 741 Op-amp, 74LS00, 74LS02, 74LS08, 74LS10, 74LS47, 74LS74, 74LS86, CD4013, CD4017.
Transistors: Two each, PN2222, PN2907, 2N3055, 2N3904, 2N3906, 2N5457.
Diodes: Two each, 1N4148, 1N4001, 1N34, 1N4728, 1N4733, 1N4739, 1N4743, 1N4747.
Miscellaneous: 25' 22AWG hook-up wire, alligator lead sets (red and black), 5V DIP relay, photo cell, microphone, speaker, buzzer, 9V battery snap, 1.5A 100V bridge, 4A 200V SCR. All housed in a plastic parts container, dimensions: 11" x 7" x 1 1/2"



Order #	(1-4 kits)	(5 kits-up)
102-150	\$79.95	\$75.95

Printed Circuit Board Fuses

• Popular in stereos and televisions • 250V
 • Five per box

Order #	Current	Order #	Current
28-2100	1.6A	28-2110	5A
28-2115	3.15A		



\$8.31(1-19 bxs) \$7.48(20-199 bxs) \$6.41(200 bxs-up)



Silicone Heat Sink Compound

Used to coat bases of power transistors and semiconductors when assembling them to heat sinks. Highly conductive grease draws heat away from device allowing it to run cooler. Net wt. 4 oz.

Order #	(1-5)	(6-11)	(12-23)	(24-up)
20-1975	\$15.95	\$15.05	\$14.35	\$13.65



Silicon Free Heat Sink Compound

Silicone free compound is applied under power transistors and other heat generating devices to assist in transferring heat to metal chassis for dissipation. Product will not harden, dry out, melt, or contaminate wave solder baths. Exceptionally low bleed and evaporation characteristics allow use with both metal and plastic cap transistors. Designed to eliminate silicone migration. Temperature range from -40°C~200°C. 4 oz. squeeze tube. Mfr. #1978-DP.



Order #	(1-5)	(6-11)	(12-23)	(24-up)
20-2145	\$22.95	\$22.26	\$21.80	\$20.88

Rauw Silicone Heat Sink Compound

• Used for heat transfer from semiconductor devices to mounting points • White • Will not dry or harden
 • 1 oz. tube

Order #	(1-5)	(6-11)	(12-23)	(24-up)
20-300	\$6.49	\$6.17	\$5.65	\$5.14



Order Toll Free 1-800-543-4330 Fax 1-800-765-6960 347

Diodes and Bridge Rectifiers

MCM offers a complete selection of rectifiers and diodes including fast recovery, super fast, high efficiency, schottky and bridge rectifiers. In addition to popular values, our zener diode selection includes 400mW, 500mW and higher voltage 1W

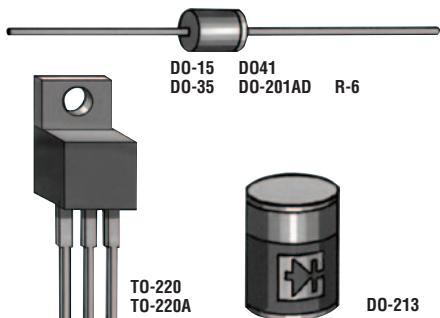

500mW Zener Diodes

•5% tolerance •DO-35 case style

Order #	Voltage	Order #	Voltage
1N5221	2.4	1N5224	2.8
1N5222	2.5	1N5225	3.0
1N5223	2.7		

\$0.55 (1-4)\$0.49 (5-9)\$0.44 (10-29)

Order #	Voltage	Order #	Voltage
1N5226B	3.3	1N5245B	15
1N5227B	3.6	1N5246B	16
1N5228B	3.9	1N5247B	17
1N5229B	4.3	1N5248B	18
1N5230B	4.7	1N5249B	19
1N5231B	5.1	1N5250B	20
1N5232B	5.6	1N5251B	22
1N5233B	6.0	1N5252B	24
1N5234B	6.2	1N5253B	25
1N5235B	6.8	1N5254B	27
1N5236B	7.5	1N5255B	28
1N5237B	8.2	1N5256B	30
1N5238B	8.7	1N5257B	33
1N5239B	9.1	1N5258B	36
1N5240B	10	1N5259B	39
1N5241B	11	1N5260B	43
1N5242B	12	1N5261B	47
1N5243B	13	1N5262B	51
1N5244B	14	1N5263B	56

\$0.19 (1-4)\$0.16 (5-9)\$0.15 (10-29)

400mW Zener Diodes

•5% tolerance •DO-35 case style

Order #	Voltage	Order #	Voltage	Order #	Voltage
1N746A	3.3	1N752A	5.6	1N759A	12
1N747A	3.6	1N754A	6.8	1N966B	16
1N748A	3.9	1N755A	7.5		
1N751A	5.1	1N758A	10		

\$0.79 (1-4)\$0.70 (5-9)\$0.61 (10-29)

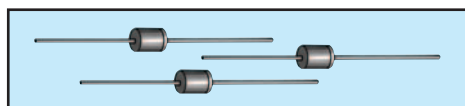

General Purpose Diodes

•2.5A •1000V •Replaces ECG® 125

Order #	(1-9)	(10-up)
2.5A 1KV	\$0.05	\$0.04

National Semiconductor Audio Power Amplifiers



Order #	Mfr. #	Description	Supply Voltage	S/N Ratio (dB)	Package/Pins	(1-24)	(25-99)
N-92F289	LM380N	2.5W, 1 Channel	-	-	14-MDIP	\$1.69	\$1.24
N-92F291	LM384N	5W, 1 Channel	26	-	14-MDIP	1.40	1.07
N-92F292	LM386M-1	Low Voltage, 1 Channel	12	-	8-SOIC NARROW	0.72	0.54
N-92F293	LM386N-1	Low Voltage, 1 Channel	12	-	8-MDIP	0.77	0.57
N-07B6623	LM386N-4	Low Voltage, 1 Channel	6	-	8-MDIP	0.94	0.71
N-07B7003	LM833MX	Dual Audio Operational Amplifier	36	-	8-SOIC	0.86	0.64
N-92F268	LM1875T	20W, 1 Channel	25	-	5-TO-220	2.73	2.09
N-92F270	LM1877M-9	Dual, 2 Channel	14	-	14-SOIC Wide	1.43	1.08
N-92F271	LM1877N-9	Dual, 2 Channel	14	-	14-MDIP	1.55	1.18
N-92F278	LM2876T	High Performance 40W with Mute 1 Channel	30	98	11-TO-220	4.30	3.37
N-92F294	LM3875T	56W, High Performance, 1 Channel	84	95	11-TO-220	5.70	4.47
N-92F296	LM3876T	56W with Mute, 1 Channel	8	98	11-TO-220	5.23	4.10
N-92F298	LM3886T	68W with Mute, 1 Channel	84	92	11-TO-220	8.23	7.10
N-92F299	LM3886TF	68W with Mute, 1 Channel	84	92	11-TO-220	5.48	4.30
N-48F2722	LM4752TS	Stereo 11W Audio Power Amplifier	24	-	7-TO-263	2.42	1.85
N-92F951	LM4755T	Stereo 11W Audio Power Amplifier	20	-	9-TO-220	2.36	1.80
N-34C6601	LM4811MM	Dual 105mW Headphone Amplifier with Volume Control and Shutdown	5	106	8-MSOP	1.80	1.32
N-48F5658	LM4835MTE	Stereo 2W with DC Volume Control Selectable Gain, 2-Channel	5	102	28-TSSOP	4.05	3.17
N-34C6605	LM4836LQ	Stereo 2W w/DC Volume Control Bass Boost, Input Mux, 2 Channel	5	102	28-LLP	3.43	2.69
N-92F304	LM4860M	1W with Shutdown Mode, 1 Channel	5	98	16-SOIC NARROW	1.84	1.39
N-92F305	LM4861M	1.1W with Shutdown Mode, 1 Channel	5	98	8-SOIC	1.84	1.39
N-92F306	LM4862M	675mW with Shutdown, 1 Channel	5	98	16-SOIC NARROW	1.73	1.31
N-48F5659	LM4863MTE	Dual 2.2W Audio Amplifier Plus Stereo Headphone Function	5	98	20-TSSOP	2.68	2.10
N-92F952	LM4864MM	725mW Audio Power Amplifier with Shutdown Mode	5	98	8-SOIC	1.39	1.05
N-74C4590	LM4865M	Strobe Edge, Transmitter	5	115	8-SOIC	1.80	1.38
N-74C4600	LM4871LD	3W Audio Power Amplifier with Shutdown Mode	5	98	8-LLP	1.39	1.05
N-07B6781	LM4871M	3W Audio Power Amplifier with Shutdown Mode	5	98	8-SOIC	1.24	0.94
N-92F312	LM4880M	Dual 200mW with Shutdown, 2 Channel	5	-	16-SOIC NARROW	1.40	1.07
N-74C4636	LM4890M	1 Watt Audio Power Amplifier	5	105	8-SOIC	1.63	1.25
N-34C6639	LM4894MM	1W Fully Differential with Shutdown Select Fixed 6dB Gain, 1 Channel	5.5	87	8-MSOP	2.36	1.80

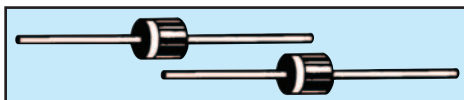

General Purpose Diode

•6A •Commonly used in stereo amplifier power supplies

Order #	Voltage	(1-4)	(5-9)
6A1	100V	\$0.46	\$0.42
6A10	1000V	0.46	0.43

1 Watt Zener Diodes

•5% tolerance •DO-41 case style

Order #	Voltage	Order #	Voltage
1N4728A	3.3	1N4742A	12
1N4729A	3.6	1N4746A	18
1N4730A	3.9	1N4747A	20
1N4731A	4.3	1N4744A	15
1N4732A	4.7	1N4745A	16
1N4733A	5.1	1N4748A	22
1N4734A	5.6	1N4749A	24
1N4735A	6.2	1N4750A	27
1N4736A	6.8	1N4751A	30
1N4737A	7.5	1N4752A	33
1N4738A	8.2	1N4753A	36
1N4739A	9.1	1N4754A	39
1N4740A	10	1N4755A	43
1N4741A	11	1N4756A	47
1N4743A	13	1N4757A	51
		1N4758A	56

\$0.29 (1-4)\$0.28 (5-9)\$0.25 (10-29)

Order #	Voltage	Order #	Voltage	Order #	Voltage
1N4760	68	1N4762	82	1N4763	91

\$0.40 (1-4)\$0.38 (5-9)\$0.33 (10-29)

Miscellaneous Diodes

Order #	(1-4)	(5-9)	(10-29)	Order #	(1-4)	(5-9)	(10-29)
1N34A	\$1.83	\$1.66	\$1.44	1N5383B	\$2.07	\$1.90	\$1.75
1N46	0.32	0.28	0.27	1N5392	0.14	0.13	0.12
1N60	0.32	0.28	0.27	1N5399	0.81	0.74	0.66
1N3754	0.72	0.66	0.61	1N5637	1.25	1.15	1.06
1N4370	0.55	0.49	0.44	1N6263	2.44	2.24	2.06
1N4759	0.49	0.44	0.39	1N6267	3.44	3.16	2.91
1N4764	0.51	0.47	0.41	1S188	0.32	0.28	0.27
1N5347	1.74	1.52	1.33	1SS99	1.49	1.37	1.26
1N5349A	1.58	1.44	1.25	1SS119	0.14	0.13	0.12
1N5356A	2.07	1.90	1.75	1SS184	0.36	0.32	0.28
1N5357B	2.07	1.90	1.75	HVP12	10.95	10.07	9.26
1N5358	2.07	1.90	1.75	MR501	0.26	0.25	0.23
1N5363	0.92	0.84	0.72	V-11N	1.86	1.71	1.57
1N5365B	2.07	1.90	1.75				
1N5366	1.35	1.23	1.07				
1N5367	2.07	1.90	1.75				

High Voltage Fast Recovery Rectifiers

Order #	Lo (A avg)	PRV (V)	Case Style	(1-4)	(5-9)	(10-29)
R1800F	.5	1800	DO-41	\$0.29	—	—
R2000F	.5	2000	DO-41	2.12	\$1.90	\$1.63



Semiconductor Database Software

•Software has information on over 84,500 semiconductors
 •Contains information on analog and digital ICs, EPROMs, transistors, FETs, diodes and thyristors
 •For most semiconductors database offers function, package, pinout, technical data and comparisons when available
 •DOS program requires 3Mb of open hard drive space



Order #	(ea.)
81-2930	\$25.70

General Purpose Silicon Rectifiers

Order #	I _o (A avg)	Case PRV (V)	Style	(1-4)	(5-9)	(10-29)
1N4001F	1.0	50 DO-41		\$0.05	\$0.05	\$0.04
1N4002F	1.0	100 DO-41		0.08	0.07	0.06
1N4003F	1.0	200 DO-41		0.08	0.07	0.06
1N4004F	1.0	400 DO-41		0.05	0.04	-
1N4005F	1.0	600 DO-41		0.08	0.07	0.06
1N4006F	1.0	800 DO-41		0.08	0.07	0.06
1N4007F	1.0	1000 DO-41		0.05	0.04	-
1N5399	1.5	1000 DO-15		0.81	0.74	0.66
RL157	1.5	1000 DO-15		2.47	2.27	2.09
RL207	2.0	1000 DO-15		0.60	0.53	0.47
2.5A 1KV	2.5	1000 DO-41		0.05	0.04	0.00
1N5400	3.0	50 DO-201AD		0.24	0.22	0.20
1N5401	3.0	100 DO-201AD		0.25	0.23	0.21
1N5402	3.0	200 DO-201AD		0.20	0.18	0.16
1N5404	3.0	400 DO-201AD		0.21	0.20	0.18
1N5405	3.0	600 DO-201AD		0.51	0.48	0.43
1N5406	3.0	600 DO-201AD		0.28	0.27	0.23
1N5408	3.0	1000 DO-201AD		0.26	0.25	0.23
6A05	6.0	50 R-6		0.45	0.42	0.38
6A1	6.0	100 R-6		0.46	0.42	0.37
6A10	6.0	100 R-6		0.46	0.43	0.39
6A2	6.0	200 R-6		0.48	0.44	0.39
6A20	6.0	200 R-6		0.48	0.44	0.39
6A4	6.0	400 R-6		0.53	0.48	0.43
6A40	6.0	400 R-6		0.53	0.48	0.43
6A6	6.0	600 R-6		0.59	0.52	0.45
6A60	6.0	600 R-6		0.59	0.52	0.45
6A8	6.0	800 R-6		0.59	0.52	0.45
6A80	6.0	800 R-6		0.59	0.52	0.45

Schottky Barrier Rectifiers

Order #	I _o (A avg)	Case PRV (V)	Style	(1-4)	(5-9)	(10-29)
1N5817	1.0	20 DO-41		\$0.43	\$0.40	\$0.36
1N5818	1.0	30 DO-41		0.44	0.40	0.36
1N5819	1.0	40 DO-41		0.45	0.42	0.38
1N5820	3.0	20 DO-201AD		0.88	0.82	0.72
1N5821	3.0	30 DO-201AD		0.88	0.82	0.72
1N5822	3.0	40 DO-201AD		0.91	0.84	0.74
SR502	5.0	20 DO-201AD		1.07	0.98	0.84
SR503	5.0	30 DO-201AD		1.07	0.98	0.84
SR504	5.0	40 DO-201AD		1.07	0.98	0.84
SR505	5.0	50 DO-201AD		1.07	0.98	0.84
SR506	5.0	60 DO-201AD		1.07	0.98	0.84
SR1620C	16.0	20 TO-220		5.89	5.42	4.99
SR1630C	16.0	30 TO-220		5.89	5.42	4.99
SR1640C	16.0	40 TO-220		5.89	5.42	4.99
SR1650C	16.0	50 TO-220		5.89	5.42	4.99

High Efficiency Rectifiers

Order #	I _o (A avg)	Case PRV (V)	TRR (nsec)	Style	(1-4)	(5-9)	(10-29)
HER101	1.0	50 DO-41			\$0.72	\$0.66	\$0.61
HER102	1.0	100 DO-41			0.72	0.66	0.61
HER103	1.0	200 DO-41			0.59	0.54	0.50
HER104	1.0	300 DO-41			0.45	0.42	0.38
HER105	1.0	400 DO-41			0.45	0.42	0.38
HER106	1.0	600 DO-41			0.45	0.42	0.38
HER107	1.0	800 DO-41			0.45	0.42	0.38
HER201	2.0	50 DO-15			0.56	0.50	0.45
HER202	2.0	100 DO-15			0.56	0.50	0.45
HER203	2.0	200 DO-15			0.56	0.50	0.45
HER204	2.0	300 DO-15			0.56	0.50	0.45
HER205	2.0	400 DO-15			0.62	0.58	0.49
HER206	2.0	600 DO-15			0.67	0.63	0.55
HER207	2.0	800 DO-15			0.74	0.68	0.61
HER301	3.0	50 DO-201AD			1.82	1.64	1.43
HER302	3.0	100 DO-201AD			1.82	1.64	1.43
HER303	3.0	200 DO-201AD			1.67	1.54	1.42
HER304	3.0	300 DO-201AD			1.82	1.64	1.43
HER305	3.0	400 DO-201AD			0.78	0.72	0.64
HER306	3.0	600 DO-201AD			0.83	0.77	0.67
HER307	3.0	800 DO-201AD			0.87	0.82	0.70
HER508	5.0	1000 DO-201AD			2.46	2.24	1.94
HER1605	16.0	400 TO-220			5.39	4.96	4.56

Fast Recovery Glass Passivated Rectifiers

Order #	I _o (A avg)	Case PRV (V)	Case Style	(ea.)
1N4947G	1.0	800 DO-41		\$0.16

Fast Recovery Rectifiers

Order #	I _o (A avg)	Case PRV (V)	TRR (nsec)	Style	(1-4)	(5-9)	(10-29)
1N4933	1.0	50 DO-41	200		\$0.15	\$0.14	\$0.12
1N4934	1.0	100 DO-41	200		0.15	0.14	0.12
1N4935	1.0	200 DO-41	200		0.17	0.16	0.14
1N4936	1.0	400 DO-41	200		0.19	0.18	0.16
1N4936G	1.0	600 DO-41	200		0.19	0.18	0.16
1N4937	1.0	400 DO-41	200		0.27	0.26	0.25
1N4937G	1.0	600 DO-41	200		0.27	0.26	0.25
1N4948	1.0	1200 DO-41	500		0.45	0.42	0.38
FR104	1.0	400 DO-41	150		0.47	0.44	0.40
FR107	1.0	1000 DO-41	500		0.47	0.44	0.40
FR157	1.5	1000 DO-15	500		0.60	0.53	0.47
FR207	2.0	1000 DO-15	500		0.92	0.85	0.74
FR257	2.5	1000 R-3	500		0.97	0.89	0.82
FR301	3.0	50 DO-201AD	150		0.77	0.70	0.63
FR302	3.0	100 DO-201AD	150		0.77	0.70	0.63
FR303	3.0	200 DO-201AD	150		0.97	0.90	0.79
FR304	3.0	400 DO-201AD	150		0.86	0.80	0.70
FR305	3.0	600 DO-201AD	250		0.97	0.89	0.79
FR306	3.0	800 DO-201AD	500		0.88	0.80	0.69
FR307	3.0	1000 DO-201AD	500		0.97	0.89	0.79
FR607	6.0	1000 R-6	500		2.59	2.26	1.94

Super Fast Rectifiers

Order #	I _o (A avg)	Case PRV (V)	TRR (nsec)	Case Style	(1-4)	(5-9)	(10-29)
SF12	1.0	100 DO-41	30		\$0.35	\$0.30	\$0.27
SF14	1.0	200 DO-41	30		0.39	0.37	0.31
SF16	1.0	400 DO-41	30		1.17	1.06	0.92
SF21	2.0	50 DO-15	50		1.58	1.44	1.25
SF24	2.0	200 DO-15	50		1.58	1.44	1.25
SF26	2.0	400 DO-15	75		1.58	1.44	1.25
SF36	2.0	400 DO-201AD	125		1.62	1.49	1.37
SF51	5.0	50 DO-201AD	150		2.69	2.40	2.08
SF56	5.0	400 DO-201AD	150		2.69	2.40	2.08
SF161C	16.0	50 TO-220	125		3.26	2.85	2.44
SF162C	16.0	100 TO-220	125		3.26	2.85	2.44
SF164A	16.0	200 TO-220	91		9.11	7.93	7.22
SF166	16.0	400 TO-220	125		9.11	7.93	7.22

High Speed Switching Rectifiers

Order #	I _o (A avg)	Case PRV (V)	TRR (nsec)	Case Style	(1-4)	(5-9)	(10-29)
MA165	100	35 DO-41			\$0.13	\$0.12	\$0.09
1S2473	110	40 DO-35	4.0		1.13	1.04	0.96
1S2076	150	35 DO-35	3.5		0.13	0.12	0.09
1N4151	200	75 DO-35	2.0		0.14	0.13	0.12
1N4448	200	75 DO-35	4.0		0.22	0.21	0.18
1N914	200	100 DO-35	4.0		0.08	0.07	0.06
1N4148	200	100 DO-35	4.0		0.06	0.05	0.04
1N4149	200	100 DO-35	4.0		0.22	0.21	0.18
1N4150	250	50 DO-35	4.0		0.32	0.28	0.25
1N4153	200	75 DO-35	4.0		1.13	1.04	0.96
1N4154	200	35 DO-35	4.0		1.13	1.04	0.96
1N4454	200	75 DO-35	2.0		0.28	0.26	0.22

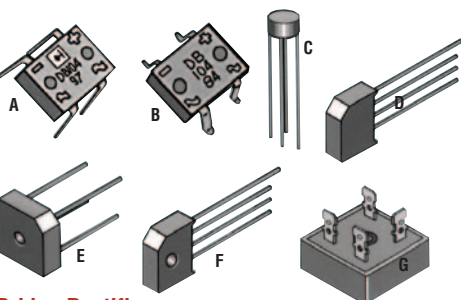

Bridge Rectifiers

•UL recognized •400V •#28-1270 is a surface mount version

Order #	Fig.	Current (A)	(1-9)	(10-up)
28-1320	A	1.0	\$0.94	\$0.85
28-1270	B	1.0	0.94	0.85
28-1325	C	1.5	0.93	0.84
28-1330	C	2.0	0.78	0.69
28-1335	D	2.0	1.64	1.58
28-1340	E	3.0	1.23	1.08
28-1345	D	4.0	1.56	1.42
28-1350	E	6.0	1.94	1.77
28-1275	F	6.0	2.33	2.17
28-1355	E	8.0	2.50	2.22
28-1360	E	10.0	3.27	3.14
28-1370	G	25.0	4.81	4.60
28-1375	G	35.0	5.59	5.24

General Purpose Rectifier Diode Kit

Save on general purpose silicon rectifiers used in virtually every piece of electronics equipment. Contains the most popular values which may be substituted for many other values to replace almost any rectifier diode. A

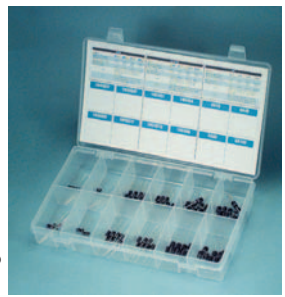

must for repair bench or schools. Also contains electrical specifications and reorder numbers. **Kit includes ten each of:** 1N4002F, 1N4004F, 1N4006F, 1N4007F, 1N5401, 1N5404, 1N5407G, 1N5408, 6A10, 6A40, 6A80, and 6A100

Order #	(kit)
102-026	\$24.95

Zener Diode Kit

•All values rated at 1W **Kit contains ten each of:**

Voltage Refill #	Voltage Refill #	Voltage Refill #
3.3V 1N4728	7.5V 1N4737	12V 1N4742
5.1V 1N4733	8.2V 1N4738	13V 1N4743
5.6V 1N4734A	9.1V 1N4739	15V 1N4744
6.2V 1N4735A	10V 1N4740	16V 1N4745
6.8V 1N4736	11V 1N4741	18V 1N4746

Order #	(kit)
102-003	\$20.95

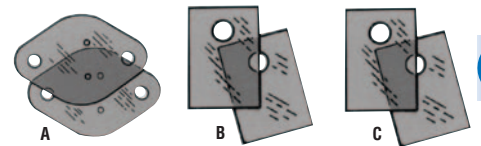

Multicomp offers a full-line of high quality bridge rectifiers available in a wide range of currents and voltages.

Transistor Insulators

Fig.	Order #	Type	Qty.	(1-9)	(10-24)	(25-49)
A	21-1165	TO-3 mica	25	\$4.32	\$3.77	\$3.44
A	21-1150	TO-3 silicon rubber	10	3.28	2.93	2.60
B	21-1170	TO-3P mica	25	4.21	3.77	3.44
B	21-1155	TO-3P silicon rubber	10	2.29	2.02	1.69
C	21-1175	TO-220 mica	25	2.52	2.14	2.02
C	21-1160	TO-220 silicon rubber	10	1.30	1.08	0.98

Transistor Reference Software

Compiled so the user can substitute transistors that perform the same, despite their different part numbers. Crosses are made according to maximum ratings and electrical characteristics. Approximately 8,000 entries.



Order #	(ea.)
81-2460	\$20.15

For Customer Service Call
1-877-626-3532

NET 30 Terms

Order Toll Free 1-800-543-4330

Fax 1-800-765-6960

349

ROHM IC Protectors, Surface Mount



•Features very reliable current cut-off capability that protects ICs and their circuits from accidental short circuit loads •50V •Operating temperature: -55~+125°C

Order #	Current (A)	(1-9)	(10-24)
ICP-S0.5	.5	\$1.19	\$1.16
ICP-S0.7	.7	1.19	1.16
ICP-S1.0	1.0	0.99	0.97
ICP-S1.2	1.2	0.69	0.68
ICP-S1.8	1.8	0.99	0.97
ICP-S2.3	2.3	0.69	0.66

IC Protectors

Original IC protectors used in many brands of VCRs and camcorders like JVC, RCA, Hitachi, Zenith and Sony.

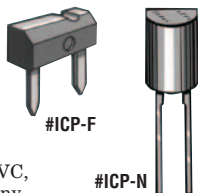

Order #	Current(A)	(1-9)	(10-up)
ICP-F10	.4	\$0.59	\$0.52
ICP-F15	.6	0.59	0.54
ICP-F20	.8	0.59	0.52
ICP-F25	1.5	0.59	0.54
ICP-F38	1.54	0.59	0.52
ICP-F50	2.0	0.59	0.52
ICP-F75	2.7	0.59	0.54
ICP-N5	.25	0.59	0.52
ICP-N10	.4	0.59	0.52
ICP-N15	.6	0.59	0.54
ICP-N20	.8	0.59	0.54
ICP-N25	1.0	0.59	0.54
ICP-N38	1.5	0.59	0.54
ICP-N50	2.0	0.59	0.54
ICP-N70	2.5	0.59	0.54
ICP-N75	2.7	0.59	0.54



Clip-On Heat Sink Set

•Five spring loaded aluminum heat sinks •Just clip onto lead of heat sensitive component to solder •Dissipates heat safely without damaging component •Five per set

Order #	(1-9 sets)	(10-24 sets)	(25-49 sets)
21-675	\$4.39	\$3.87	\$3.46

VOLTAGE REGULATOR SELECTOR GUIDE

Order #	ERS/ECG/NTE Cross Reference	Voltage Positive/Negative	Output I _o V _{OUT} (DC)	Input Voltage A D/C	V In (DC) Max	TO-92		TO-220
						Min	PD Watts	
TO-92								
78L05	977	Positive	5	0.1	30	7	0.7	
79L05	1917	Negative	5	0.1	30	7	0.7	
78L08	981	Positive	8	0.1	30	10	1.0	
78L12	950	Positive	12	0.1	35	14	0.7	
79L12	1903	Negative	12	0.1	35	14	0.7	
78L15	951	Positive	15	0.1	35	17	0.7	
79L15	1905	Negative	15	0.1	35	17	0.7	
78L18	1906	Positive	18	0.1	35	20	0.7	
SK10050	1908	Positive	24	0.1	40	26	0.7	
TO-220								
7805	960	Positive	5	1.0	35	7	15	
7905	961	Negative	5	1.0	35	7	15	
7806	962	Positive	6	1.0	35	8	15	
7906	963	Negative	6	1.0	35	8	15	

VOLTREX® Low-Profile Machined Pin Solder-Tail Sockets

Order #	Pins	Contact Plating	(1-9)	(10-49)	(50-up)
28-8168	18	Gold	\$1.32	\$1.23	\$1.12
28-8182	24	Tin	1.32	1.23	1.12
28-8185	40	Tin	2.08	—	—
28-8174	48	Gold	3.18	3.08	2.86
28-8186	48	Tin	2.64	2.60	2.38



VOLTREX® Wire-Wrap DIP Sockets

•Standard profile DIP sockets with wire-wrap termination

Order #	Pins	Contact Plating	(1-9)	(10-49)	(50-up)
28-8150	14	Gold	\$1.75	\$1.69	\$1.46
28-8152	16	Gold	1.98	1.92	1.69
28-8153	16	Tin	1.64	1.58	1.36
28-8155	24	Gold	3.18	3.08	2.74
28-8156	28	Gold	3.41	3.29	2.96
28-8157	40	Gold	4.85	4.76	4.54

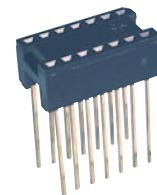

VOLTREX® Super Flat IC Sockets

•Super-flat machined pin low-profile DIP sockets

Order #	Pins	(1-9)	(10-49)	(50-up)
28-8190	16	\$1.53	\$1.46	\$1.36
28-8191	18	1.64	1.53	1.42
28-8192	20	1.86	1.80	1.58
28-8193	24	0.75	—	—
28-8195	40	3.41	3.28	3.05



TO-220 Style Heat Sinks

Order #	Mfr. #	Dimensions		(1-29)	(30-49)	(50-up)
		(H)	(W)			
28-4338	4880	-	-	\$0.90	\$0.72	\$0.62
28-4340	7128D	1.040"	.866"	0.85	0.73	0.62
28-4365	6025B-TT	1.250"	.875"	1.94	1.68	1.36
28-4386	274-2AB	.520"	.500"	0.30	0.27	0.22



Suffixes: D Copper Material, TT Tin Tabbed, AB Black Anodized Aluminum

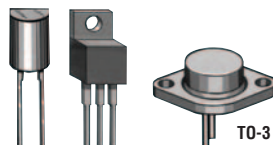

Order #	ERS/ECG/NTE Cross Reference	Voltage Positive/Negative	Output I _o V _{OUT} (DC)	Input Voltage A D/C	V In (DC) Max	TO-92		TO-220
						Min	PD Watts	
TO-220								
7808	964	Positive	8	1.0	35	10	15	
7908	965	Negative	8	1.0	35	10	15	
7810	1932	Positive	10	1.0	35	12	20	
7812	966	Positive	12	1.0	35	14	15	
7912	967	Negative	12	1.0	35	14	15	
7815	968	Positive	15	1.0	35	17	15	
7915	969	Negative	15	1.0	35	17	15	
7818	958	Positive	18	1.0	35	20	15	
7918	959	Negative	18	1.0	35	20	15	
7824	972	Positive	24	1.0	40	26	15	
7924	971	Negative	24	1.0	40	26	15	
TO-3								
LM309	309K	Positive	5	1.5	35	7.5	20	
SK9334	1913	Negative	5	1.5	35	7.5	20	
L7812	1914	Positive	12	1.5	35	14.1	15	
M-MC7915CT	1919	Negative	15	1.5	40	17.4	20	
SK10053	1920	Positive	18	1.5	35	20.5	20	
SK10054	1923	Negative	18	1.5	35	20.5	20	

Dip IC Sockets

Order #	Pins	(1-9)	(10-49)	(50-up)
28-233	8	\$0.29	\$0.27	\$0.22
28-235	14	0.29	0.28	0.24
28-238	16	0.26	0.24	0.21
28-239	18	0.47	0.44	0.41
28-240	20	0.28	0.27	0.24
28-244	24	0.40	0.38	0.35
28-245	28	0.40	0.37	0.34
28-248	40	0.45	0.41	0.37
28-249	42	0.61	0.53	0.42

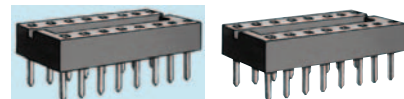

TO-3 Transistor Socket

•Ideal for prototype work or replacing broken TO-3 sockets •Five per package

Order #	(1-2 pkgs.)	(3 pkgs.-up)
21-1645	\$6.75	\$6.02



Mini Jumpers

•Allows quick connection of circuits on circuit boards •Shorting socket jumper for address or code strip line plugs •25 per bag

Order #	Type	Height	(1-4 bags)	(5 bags-up)
83-2170	Open	4mm	\$1.12	\$1.04
83-2175	Closed	6mm	1.12	1.01
83-2180	Open	6mm	1.29	1.19
83-2190	Open	8mm	1.12	1.01

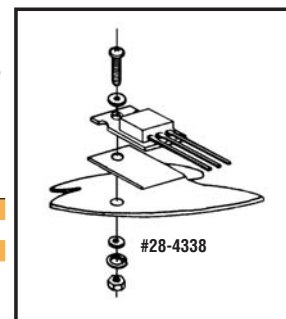

TRANSISTOR SELECTOR GUIDE

Whether you're a manufacturer looking for a certain specification or a technician with an impossible to find part number, you can find it in this easy-to-read chart. Compare the case style below to find the equivalent semiconductor. See semiconductor pages for pricing.

NPN	PNP	Application	VCBO	IC	Power
TO-3					
2SC1891	-	Audio Output	1200V	1.5A	50W
2SD898	-	Audio Output	1500V	3A	50W
2SD869	-	Horizontal Output	1500V	3.5A	50W
2SC1172	-	Horizontal Output	1500V	5A	50W
2SC2928	-	Horizontal Output	1500V	5A	50W
2SC3659	-	Horizontal Output	1500V	5A	50W
2SD900	-	Horizontal Output w/Damper	1500V	5A	50W
2SD870	-	Horizontal Output	1500V	5A	50W
2SD820	-	Horizontal Output	1500V	5A	50W
2SD1186	-	Horizontal Output	1500V	5A	50W
2SD821	-	Horizontal Output	1500V	6A	50W
2SD871	-	Horizontal Output	1500V	6A	50W
2SC1172B	-	Horizontal Output	1500V	7A	50W
2SD822	-	Horizontal Output	1500V	7A	50W
2SD905	-	Horizontal Output	1400V	8A	50W
BUY69A	-	Horizontal Output	1000V	10A	100W
MJ3055	MJ2955	Audio Output Pair	60V	12A	115W
2N3055	-	General Purpose	100V	15A	115W
2SD424	2SB554	Audio Output Pair	180V	15A	150W
2SD555	2SB600	Audio Output Pair	250V	10A	200W
TO-3P					
2SD1554	-	Horizontal Output w/Damper	1500V	3.5A	40W
2SD1453	-	Horizontal Output	1500V	3A	50W
2SD1650	-	Horizontal Output w/Damper	1500V	3.5A	50W
2SD1555	-	Horizontal Output w/Damper	1500V	5A	50W
2SD1398	-	Horizontal Output w/Damper	1500V	5A	50W
2SD1455	-	Horizontal Output	1500V	5A	50W
2SD1556	-	Horizontal Output w/Damper	1500V	6A	50W
2SD1497	-	Horizontal Output	1500V	6A	50W
2SD1941	-	Horizontal Output	1500V	6A	50W
2SC3180	2SA1263	Audio Output Pair	80V	6A	60W
2SD1651	-	Horizontal Output w/Damper	1500V	5A	60W
2SD1652	-	Horizontal Output w/Damper	1500V	6A	60W
2SD1879	-	Horizontal Output w/Damper	1500V	6A	60W
2SD1441	-	Horizontal Output w/Damper	1500V	4A	70W
2SC3181	2SA1264	Audio Output Pair	120V	8A	80W
2SD718	2SB688	Audio Output Pair	120V	8A	80W
2SC3854	2SA1490	Audio Output Pair	120V	8A	80W
2SD1426	-	Horizontal Output w/Damper	1500V	3.5A	80W
2SD1427	-	Horizontal Output w/Damper	1500V	5A	80W
2SD1428	-	Horizontal Output w/Damper	1500V	6A	80W
2SD1065	-	Regulator Switch	60V	15A	90W
2SC3182	2SA1265	Audio Output Pair	140V	10A	100W
2SC3855	2SA1491	Audio Output Pair	140V	10A	100W
2SC2581	2SA1106	Audio Output Pair	140V	10A	100W
2SC2837	2SA1186	Audio Output Pair	150V	10A	100W
2SC3153	-	Regulator Switch	900V	6A	100W

NPN	PNP	Application	VCBO	IC	Power
TO-3P					
2SD1047	2SB817	Audio Output Pair	160V	12A	120W
2SC3280	2SA1301	Audio Output Pair	160V	12A	120W
2SC3907	2SA1516	Audio Output Pair	180V	12A	130W
2SC3856	2SA1492	Audio Output Pair	180V	15A	130W
2SC3281	2SA1302	Audio Output Pair	200V	15A	150W
2SD1403	-	Horizontal Output	1500V	6A	150W
TO-92					
*ECB Basing except for MPSA43 and MPSA92 which have a Basing of ECB					
2SC945	2SA733	General Purpose Amplifier	60V	.1A	.25W
2SC2240	-	General Purpose Amplifier	120V	.1A	.3W
2SC1815	-	General Purpose Amplifier	60V	.15A	.4W
2SC1845	-	General Purpose Amplifier	120V	.5A	.5W
2SC2274	2SA984	General Purpose Amplifier	60V	.5A	.6W
MPSA43	MPSA92	High-Voltage Amplifier	200V	.5A	.625W
2SD438	2SB560	General Purpose Amplifier	100V	.7A	.9W
TO-220					
2SC1969	-	CB Output	60V	6A	20W
2SC3298	2SA1306	Power Amp, Isolated Tab	160V	1.5A	20W
2SC2238	2SA968	Audio Output Pair	160V	1.5A	25W
2SC2344	2SA1011	Audio Output Pair	180V	1.5A	25W
2SD386	-	Vertical Output	200V	2A	25W
2SD401	-	Vertical Output	200V	2A	25W
2SD313	2SB507	Audio Output Pair	60V	3A	30W
2SD526	2SB596	Audio Output Pair	80V	4A	30W
2SC1826	2SA768	Audio Output Pair	80V	4A	30W
2SC1986	2SA771	Audio Output Pair	80V	6A	40W
2SD525	2SB595	Audio Output Pair	100V	5A	40W
2SD613	2SB633	Audio Output Pair	100V	6A	40W
2SC2810	-	H.V. Switch, Regulator	500V	7A	50W
2SC2898	-	H.V. Switch, Regulator	500V	8A	50W
TO-66					
2SC1445	2SA765	Vertical & Audio Output Pair	80V	6A	40W
TO-5					
2N3440	-	Video Output	250V	1A	5W
TB-34					
2SC2921	2SA1215	Audio Output Pair	160V	15A	150W
2SC2773	2SA1169	Audio Output Pair	200V	15A	150W
2SC2922	2SA1216	Audio Output Pair	180V	17A	200W
2SC2774	2SA1494	Audio Output Pair	200V	17A	200W
2SC3858	2SA1170	Audio Output Pair	200V	17A	200W
TO-126					
2SD600	2SB631	Audio Driver/Output Pair	100V	1A	8W
2SC3117	2SA1249	Audio Driver/Output Pair	180V	1.5A	10W
2SD669	2SB649	Audio Driver/Output Pair	180V	1.5A	20W

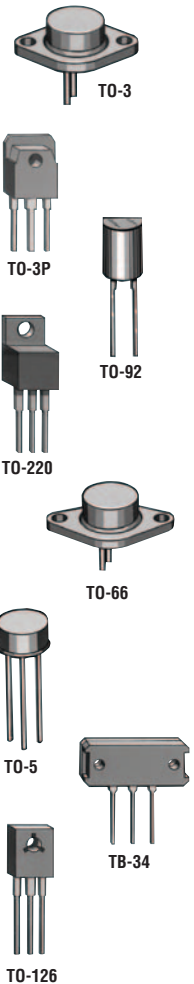

NTE



QUICKCross™

•NTE's popular electronic cross-reference CD software, version 12.0 •Works on any PC compatible running WIN95/98/XP or NT with 12Mb of free disk space **Features:** •Three fully updated cross-reference databases for semiconductors, relays and potentiometers •New cross-reference search database for switches •Selector guides for capacitors, resistors and hook-up wire •PDF catalogs for lightwave LED flashlights and ECG chemicals, solder irons, outlet strips, test equipment and antenna rotors •When connected to the internet, you can check distributor inventory right from the cross reference screen •Includes active links to data sheets available on NTE's web site and local active links to many informational flyer and catalogs



NTE 138 Piece Transistor/Diode Kit

•Contains 30 of the most popular transistors, diodes, rectifiers and MOSFETs •Housed in a 30 drawer cabinet •Includes a NTE Semiconductor Cross Reference Guide •**Kit contains:**

Type	Qty	Type	Qty	Type	Qty	Type	Qty
NTE109	5	NTE261	5	NTE379	5	NTE2337	2
NTE116	10	NTE262	5	NTE392	2	NTE2377	2
NTE123AP	5	NTE263	5	NTE519	5	NTE2385	2
NTE125	10	NTE264	5	NTE558	5	NTE2389	2
NTE128P	5	NTE331	5	NTE2302	5	NTE2393	2
NTE129P	5	NTE332	5	NTE2312	2	NTE2395	2
NTE156	10	NTE377	5	NTE2324	2		
NTE159	5	NTE378	5	NTE2331	5		

Order #	(1-4 kits)	(5-9 kits)	(10 kits-up)
NTECOM1	\$245.00	\$240.00	\$230.00



Semiconductor Cross Reference Guide

The 12th edition of this technical guide and cross reference is designed to give engineers, technicians and buyers assistance in selecting the NTE component best suited to their application. It includes technical information for thousands of NTE components and lists replacements for approximately 383,000 US, Asian and European semiconductors.

Order #	(1-9)	(10-49)
EL01-012	\$4.39	\$4.11



Order Toll Free **1-800-543-4330** Fax 1-800-765-6960 **351**



NTE ELECTRONICS, INC.

The NTE Semiconductor product line encompasses a wide variety of high quality devices, which meet Industrial, MRO and Consumer Electronics replacement needs.

Call MCM today with all your semiconductor requirements!

Table with 4 columns: Order #, (1-4), (5-9), (10-29). Rows include NTE101 through NTE180.

Table with 4 columns: Order #, (1-4), (5-9), (10-29). Rows include NTE181 through NTE2374.

Table with 4 columns: Order #, (1-4), (5-9), (10-29). Rows include NTE2375 through NTE2920.

Table with 4 columns: Order #, (1-4), (5-9), (10-29). Rows include NTE294 through NTE4066B.

Table with 4 columns: Order #, (1-4), (5-9), (10-29). Rows include NTE4066BT through NTE5322.



Order #	(1-4)	(5-9)	(10-29)
NTE5324	\$6.69	\$6.15	\$5.66
NTE5326	7.19	6.61	6.08
NTE5329	3.09	2.84	2.61
NTE5330	5.29	4.87	4.48
NTE5331	7.09	6.52	6.00
NTE5332	1.59	1.46	1.34
NTE5340	10.95	10.07	9.26
NTE5342	13.95	12.83	11.80
NTE5344	15.95	14.67	13.50
NTE54	3.55	3.27	3.01
NTE5400	0.89	0.82	0.75
NTE5401	1.12	1.03	0.95
NTE5402	1.15	1.06	0.98
NTE5404	1.28	1.18	1.09
NTE5405	2.40	2.21	2.03
NTE5417	2.19	2.01	1.85
NTE5418	2.55	2.35	2.16
NTE5419	3.02	2.78	2.56
NTE5424	7.19	6.61	6.08
NTE5455	1.78	1.64	1.51
NTE5457	1.86	1.71	1.57
NTE5458	2.05	1.89	1.74
NTE5465	2.95	2.71	2.49
NTE5466	4.23	3.89	3.58
NTE55	4.56	4.20	3.86
NTE552	1.45	1.33	1.22
NTE5536	11.95	10.99	10.11
NTE5539	10.95	10.07	9.26
NTE5552	4.04	3.72	3.42
NTE5554	5.79	5.33	4.90
NTE5556	7.29	6.71	6.17
NTE5558	11.95	10.99	10.11
NTE558	1.61	1.48	1.36
NTE56	3.52	3.24	2.98
NTE56004	3.61	3.32	3.05
NTE56006	4.66	4.29	3.95
NTE56008	5.49	5.05	4.65
NTE56017	6.09	5.60	5.15
NTE56020	11.95	10.99	10.11
NTE56024	24.95	22.95	21.11
NTE56026	28.95	26.63	24.50
NTE5607	3.04	3.62	3.33
NTE5608	3.96	2.82	2.59
NTE5609	4.03	3.71	3.41
NTE5620	6.89	6.34	5.83
NTE5629	2.58	2.37	2.18
NTE5633	3.19	2.93	2.70
NTE5635	4.89	4.50	4.14

Order #	(1-4)	(5-9)	(10-29)
NTE5637	\$6.09	\$5.60	\$5.15
NTE5638	3.66	3.37	3.10
NTE5645	4.07	3.74	3.44
NTE5646	4.53	4.17	3.84
NTE5656	1.74	1.60	1.47
NTE5657	3.45	3.17	2.92
NTE5671	5.99	5.51	5.07
NTE5679	27.95	25.71	23.65
NTE569	1.13	1.04	0.96
NTE570	1.50	1.38	1.27
NTE571	0.97	0.89	0.82
NTE572	1.06	0.98	0.90
NTE574	0.59	0.54	0.50
NTE575	0.59	0.54	0.50
NTE576	1.62	1.49	1.37
NTE577	4.11	3.78	3.48
NTE578	1.77	1.63	1.50
NTE579	2.69	2.47	2.27
NTE580	3.27	3.01	2.77
NTE5801	0.72	0.66	0.61
NTE5802	0.83	0.76	0.70
NTE5804	1.12	1.03	0.95
NTE5806	1.39	1.28	1.18
NTE5809	2.47	2.27	2.09
NTE581	3.04	2.80	2.58
NTE5812	1.50	1.38	1.27
NTE5814	1.75	1.61	1.48
NTE5815	2.75	2.53	2.33
NTE5817	3.52	3.24	2.98
NTE583	2.44	2.24	2.06
NTE585	1.35	1.24	1.14
NTE586	1.81	1.67	1.54
NTE587	0.72	0.66	0.61
NTE5870	8.59	7.90	7.27
NTE588	1.67	1.54	1.42
NTE589	1.40	1.29	1.19
NTE592	1.77	1.63	1.50
NTE593	1.77	1.63	1.50
NTE595	1.73	1.59	1.46
NTE596	1.71	1.57	1.44
NTE597	1.99	1.83	1.68
NTE598	2.19	2.01	1.85
NTE60	9.95	9.15	8.42
NTE601	0.42	0.39	0.36
NTE6013	5.59	5.14	4.73
NTE6076	15.95	14.67	13.50
NTE6083	1.52	1.40	1.29
NTE6085	5.99	5.51	5.07

Order #	(1-4)	(5-9)	(10-29)
NTE6087	\$5.69	\$5.23	\$4.81
NTE6090	7.09	6.74	6.40
NTE61	11.95	10.99	10.11
NTE614	1.15	1.06	0.98
NTE617	1.57	1.44	1.32
NTE657	2.84	2.61	2.40
NTE620	1.71	1.62	1.54
NTE621	2.36	2.17	2.00
NTE622	2.11	1.94	1.78
NTE6240	4.35	4.00	3.68
NTE6241	5.39	4.96	4.56
NTE6244	4.99	4.59	4.22
NTE6401	8.69	7.99	7.35
NTE6403	7.79	7.17	6.60
NTE6408	1.05	0.97	0.89
NTE6409	9.39	8.64	7.95
NTE6410	7.39	6.80	6.26
NTE66	10.95	10.07	9.26
NTE68	10.95	10.07	9.26
NTE6821	7.99	7.35	6.76
NTE7039	4.99	4.59	4.22
NTE7041	6.49	6.17	5.86
NTE7045	4.52	4.16	3.83
NTE7051	5.29	4.87	4.48
NTE7055	2.48	2.28	2.10
NTE7081	10.95	10.07	9.26
NTE7085	3.13	2.88	2.65
NTE7096	4.03	3.71	3.41
NTE7097	3.04	2.80	2.58
NTE7098	3.04	2.80	2.58
NTE7104	2.91	2.68	2.47
NTE7108	11.95	10.99	10.11
NTE7124	1.95	1.79	1.65
NTE7126	15.95	14.67	13.50
NTE7400	1.57	1.44	1.32
NTE7402	1.90	1.75	1.61
NTE7404	0.86	0.82	0.75
NTE7406	1.49	1.37	1.26
NTE7408	1.07	0.98	0.90
NTE7417	1.27	1.17	1.08
NTE7432	1.30	1.20	1.10
NTE7445	2.95	2.71	2.49
NTE7447	3.37	3.10	2.85
NTE7476	1.82	1.62	1.44
NTE7490	1.56	1.44	1.32
NTE74C14	2.00	1.84	1.69
NTE74LS00	1.14	1.05	0.97
NTE74LS03	1.00	0.92	0.85

Order #	(1-4)	(5-9)	(10-29)
NTE74LS136S	1.02	\$0.94	\$0.86
NTE75188	1.93	1.78	1.64
NTE778A	3.62	3.33	3.06
NTE778S	3.88	3.57	3.28
NTE778SM	1.62	1.54	1.42
NTE788	6.69	6.15	5.66
NTE8085	1.52	1.40	1.29
NTE8098	1.52	1.40	1.29
NTE8108	1.52	1.40	1.29
NTE8115	1.52	1.40	1.29
NTE8118	1.52	1.40	1.29
NTE8139	1.52	1.40	1.29
NTE8149	1.52	1.40	1.29
NTE8167	1.52	1.40	1.29
NTE8181	1.52	1.40	1.29
NTE8213	1.52	1.40	1.29
NTE8226	1.52	1.40	1.29
NTE823	2.19	2.01	1.85
NTE8242	1.52	1.40	1.29
NTE834	2.74	2.52	2.32
NTE834SM	1.81	1.67	1.54
NTE85	0.97	0.89	0.82
NTE85-5	3.42	3.15	2.90
NTE857M	3.88	3.57	3.28
NTE858M	3.45	3.17	2.92
NTE858SM	2.23	2.05	1.89
NTE859	4.49	4.13	3.80
NTE859SM	3.42	3.15	2.90
NTE860	5.19	4.77	4.39
NTE87	8.59	7.90	7.27
NTE89	8.99	8.27	7.61
NTE891M	1.53	1.45	1.38
NTE891SM	1.30	1.20	1.10
NTE92	10.95	10.07	9.26
NTE923D	1.81	1.67	1.54
NTE928M	2.97	2.73	2.51
NTE928SM	1.66	1.53	1.41
NTE93	14.95	13.75	12.65

Order #	(1-4)	(5-9)	(10-29)
NTE931	\$12.95	\$11.91	\$10.96
NTE935	14.95	13.75	12.65
NTE937	11.95	10.99	10.11
NTE937M	7.19	6.61	6.08
NTE94	6.09	5.60	5.15
NTE941	9.09	8.36	7.69
NTE941M	1.02	0.94	0.86
NTE943M	3.69	3.39	3.12
NTE943SM	1.71	1.57	1.44
NTE947D	6.09	5.60	5.15
NTE948	3.41	3.14	2.89
NTE950	2.13	1.96	1.80
NTE953	9.59	8.82	8.11
NTE955M	1.77	1.63	1.50
NTE955MC	1.62	1.49	1.37
NTE956	3.06	2.82	2.59
NTE957	3.60	3.31	3.05
NTE960	3.54	3.26	3.00
NTE961	4.56	4.20	3.86
NTE962	3.70	3.40	3.13
NTE964	3.37	3.10	2.85
NTE966	3.73	3.43	3.16
NTE967	5.19	4.77	4.39
NTE968	3.66	3.37	3.10
NTE969	4.99	4.59	4.22
NTE970	11.95	10.99	10.11
NTE972	3.54	3.26	3.00
NTE977	1.68	1.55	1.43
NTE978	2.64	2.43	2.24
NTE981	2.00	1.84	1.69
NTE987	2.36	2.17	2.00
NTE987SM	1.38	1.27	1.17
NTE990	6.09	5.79	5.33
NTE997	4.03	3.71	3.41
NTE999	1.54	1.42	1.31
NTE999SM	1.24	1.18	1.12

NTE ELECTRONICS, INC. **Surface Mount Bipolar Transistors**

Order #	Qty./Pkg.	Description	Case	(1-4 pkgs.)	(5-9 pkgs.)
NTE2401	2	PNP-SI, RF stages in FM front ends	SOT-23	\$2.19	\$2.01
NTE2402	1	NPN-SI, low noise UHF/VHF amp (compl. to NTE2403)	SOT-23	2.61	2.48
NTE2403	1	PNP-SI, low noise UHF/VHF amp (compl. to NTE2402)	SOT-23	2.95	2.71
NTE2404	2	NPN-SI, darlington (compl. to NTE 2405)	SOT-23	2.21	2.03
NTE2405	2	PNP-SI, darlington (compl. to NTE 2404)	SOT-23	2.21	2.03
NTE2406	2	NPN-SI, general purpose amp (compl. to NTE2407)	SOT-23	2.03	1.87
NTE2407	2	PNP-SI, general purpose amp (compl. to NTE2406)	SOT-23	2.13	1.96
NTE2408	2	NPN-SI, low noise driver output (compl. to NTE2409)	SOT-23	1.90	1.81
NTE2409	2	PNP-SI, low noise driver output (compl. to NTE2408)	SOT-23	1.76	1.67
NTE2410	2	NPN-SI, high voltage amp/driver (compl. to NTE2411)	SOT-23	1.90	1.81
NTE2411	2	PNP-SI, high voltage amp/driver (compl. to NTE 2410)	SOT-23	2.04	1.88
NTE2412	2	NPN-SI, general purpose high voltage amp (compl. to NTE 2413)	SOT-23	1.90	1.75
NTE2413	2	PNP-SI, general purpose high voltage amp (compl. to NTE2412)	SOT-23	1.90	1.75
NTE2414	2	NPN-SI digital with 2 built-in bias 10K resistors (compl. to NTE2415)	SOT-23	1.71	1.57
NTE2415	2	PNP-SI, digital with 2 built-in bias 10K resistors (compl. to NTE2414)	SOT-23	1.71	1.57
NTE2416	2	NPN-SI, digital with 2 built-in bias 22K resistors (compl. to NTE2417)	SOT-23	2.24	2.06
NTE2417	2	PNP-SI, digital with 2 built-in bias 22K resistors (compl. to NTE2416)	SOT-23	1.71	1.57
NTE2418	2	NPN-SI, digital with 2 built-in bias 47K resistors (compl. to NTE2419)	SOT-23	1.71	1.57
NTE2419	2	PNP-SI, digital with 2 built-in bias 47K resistors (compl. to NTE 2418)	SOT-23	1.71	1.57
NTE2426	1	NPN-SI, darlington general purpose amp (compl. to NTE2427)	SOT-89	1.70	1.56
NTE2427	1	PNP-SI, darlington switch (compl. to NTE2426)	SOT-89	1.75	1.61
NTE2428	1	NPN-SI, general purpose amp, switch (compl. to NTE 2429)	SOT-89	1.67	1.59
NTE2429	1	PNP-SI, general purpose amp, switch (compl. to NTE2428)	SOT-89	2.40	2.28
NTE2430	1	NPN-SI, high voltage amp/switch (compl. to NTE2431)	SOT-89	1.88	1.73
NTE2431	1	PNP-SI, high voltage amp/switch (compl. to NTE2430)	SOT-89	1.61	1.48
NTE2643	1	NPN-SI, VHF/UHF low noise amp	-	0.65	0.62

NTE ELECTRONICS, INC. **Surface Mount Diodes and Rectifiers**

Order #	Qty./Pkg.	Description	Case	(1-4 pkgs.)	(5-9 pkgs.)
NTE592	3	High voltage, general purpose	SOT-23	\$1.77	\$1.63
NTE593	3	High speed, switch	SOT-23	1.77	1.63
NTE594	3	Bandswitch	SOT-23	1.77	1.63
NTE595	3	Dual common cathode high speed	SOT-23	1.73	1.59
NTE596	3	Dual common anode high speed	SOT-23	1.71	1.57
NTE620	5	High voltage general purpose rectifier	DO-213AA	1.71	1.62
NTE621	5	High voltage			

NTE Surface Mount Linear ICs

•One piece per package

Order #	Description	Case	(1-4)	(5-9)
NTE778SM	Dual operational-amp NE4558D	SOIC-8	\$1.62	\$1.54
NTE832SM	Tone decoder LM567CD CM	SOIC-8	1.81	1.67
NTE834SM	Low power, low offset, quad comparator, LM339FP, D, M	SOIC-14	1.81	1.67
NTE857SM	Low noise J-FET input operational amp	SOIC-8	1.57	1.44
NTE858SM	Quad low noise J-FET input operational amp NJM353M	SOIC-8	2.23	2.05
NTE859SM	Quad low noise J-FET input operational amp	SOIC-14	3.42	3.15
NTE891SM	Dual audio operational amp, NJM2068M	SOIC-8	1.30	1.20
NTE918SM	High speed operational amp, LM318M, F	SOIC-8	2.80	2.58
NTE922SM	Voltage comparator, LM311D	SOIC-8	1.19	1.13
NTE927SM	Differential video amp, NE592A, D	SOIC-14	1.71	1.62
NTE928SM	Low power dual operational amp, LM358D, FP, M	SOIC-8	1.66	1.53
NTE941SM	Freq comp operational amp LM741CM	SOIC-8	1.20	1.14
NTE943SM	Low power, low offset, Dual voltage comp, LM393FP, D, M	SOIC-8	1.71	1.57
NTE948SM	Quad operational amp, LM348D, FP, M	SOIC-14	1.95	1.79
NTE955SM	Monolithic timer, LM555CM, DN1	SOIC-8	1.28	1.22
NTE975SM	General purpose operational amp LM301DN1	SOIC-8	1.81	1.67
NTE978SM	Dual timer, LM556M, DN1	SOIC-14	1.85	1.70
NTE987SM	Quad, low power operational amp, LM324D, FP, M	SOIC-14	1.38	1.27
NTE999SM	Programmable precision reference output to 36V, LM341ACM	SOIC-8	1.24	1.18
NTE1869SM	3 terminal variable voltage regulator	SOT-89	1.55	1.47

NTE Surface Mount CMOS ICs

•One piece per package

Order #	Description	Case	(1-4)	(5-9)
NTE4000T	Dual 3-input plus inverter nor gate	SOIC-14	\$0.87	\$0.80
NTE4001BT	Quad 2-input nor gate	SOIC-14	0.78	0.72
NTE4002BT	Dual, 4-input nor gate	SOIC-14	0.78	0.72
NTE4007T	Dual, complimentary pair plus inverter	SOIC-14	0.78	0.72
NTE4011BT	Quad, 2-input nand gate	SOIC-14	0.78	0.72
NTE4012BT	Dual, 4-input nand gate	SOIC-14	0.78	0.72
NTE4013BT	Dual, t-type flip-flop	SOIC-14	0.78	0.72
NTE4015BT	Dual, 4-stage static shift register with serial input/parallel output	SOIC-14	0.99	0.94
NTE4016BT	Quad, bilateral switch for transmission of multiplexing of digital signals	SOIC-14	0.85	0.78
NTE4020BT	14-stage ripple-carry binary counter/divider	SOIC-16	1.25	1.15
NTE4021BT	8-stage static shift register	SOIC-16	0.99	0.94
NTE4023BT	Triple 3-input nand gate	SOIC-14	0.78	0.72
NTE4025BT	Triple 3-input nor gate	SOIC-14	0.78	0.72
NTE4027BT	Dual J-K master slave flip-flop	SOIC-16	0.92	0.85
NTE4028BT	BCD-to-decimal decoder	SOIC-16	1.16	1.10
NTE4029BT	Presetable up/dpwn counter, binary or BCD decade decoder	SOIC-16	1.43	1.32
NTE4040BT	12-stage, ripple-carry, binary counter/divider	SOIC-16	0.94	0.86
NTE4042BT	Quad, clocked d-type latch	SOIC-16	1.00	0.92
NTE4043BT	Quad, 3-state, nor R/S latch	SOIC-16	1.03	0.98
NTE4044BT	Quad 3-state, nand R/S latch	SOIC-16	1.03	0.98
NTE4046BT	Phase lock loop (PLL)	SOIC-16	1.07	1.02
NTE4047BT	Low power, monostable/astable multivibrator	SOIC-14	1.00	0.92
NTE4049T	Hex buffer/converter (inverting)	SOIC-16	1.44	1.32
NTE4050BT	Hex buffer/converter (non-inverting)	SOIC-16	0.92	0.87
NTE4051BT	Single, 8-channel analog multiplexer/demultiplexer	SOIC-16	0.94	0.86
NTE4052BT	Differential, 4-channel analog multiplexer	SOIC-16	0.94	0.86
NTE4053BT	Triple, 2-channel analog multiplexer	SOIC-16	0.94	0.86
NTE4060BT	14-stage ripple-carry binary counter/divider and OSC	SOIC-16	1.40	1.29
NTE4066BT	Quad, bilateral switch	SOIC-14	0.92	0.85
NTE4068BT	8-input nand/and gate, high voltage type	SOIC-14	0.78	0.72
NTE4069T	Hex inverter, high voltage type	SOIC-14	1.20	1.14
NTE4070BT	Quad exclusive or gate	SOIC-14	0.78	0.72
NTE4071BT	Quad, 2-input or gate	SOIC-14	0.78	0.72
NTE4073BT	Triple, 3-input and gate	SOIC-14	0.78	0.72
NTE4075BT	Triple, 3-input or gate	SOIC-14	0.78	0.72
NTE4077BT	Quad, exclusive nor gate	SOIC-14	0.78	0.72
NTE4093BT	Quad, 2-input nand schmitt trigger	SOIC-14	0.85	0.78
NTE4094BT	8-stage shift and storage bus register	SOIC-16	1.83	1.68
NTE4510BT	Pre-settable up/down BCD convertor	SOIC-16	1.44	1.37
NTE4511BT	BCD-to-seven-segment latch decoder driver	SOIC-16	0.99	0.94
NTE4520BT	Dual up/down binary counter	SOIC-16	1.43	1.36
NTE4528BT	Dual, retriggerable/resettable monostable multivibrator	SOIC-16	1.40	1.33
NTE4541BT	Programmable timer	SOIC-14	1.40	1.29
NTE40106BT	Hex schmitt trigger	SOIC-14	1.05	0.97
NTE40174BT	Hex, D-type flip-flop	SOIC-16	0.87	0.83

Capacitor Kits

Miniature Radial Aluminum Electrolytic Capacitor Kit

•Kit consists of 90 radial electrolytic, 30 different values, three of each type •Cabinet contains 15 compartments with dividers •Each drawer clearly labeled



•Values: 1µF/50V, 1µF/160V, 1µF/250V, 2.2µF/50V, 4.7µF/50V, 4.7µF/160V, 10µF/16V, 10µF/25V, 10µF/35V, 10µF/50V, 10µF/100V, 10µF/160V, 10µF/250V, 10µF/350V, 47µF/25V, 47µF/50V, 47µF/100V, 100µF/16V, 100µF/25V, 100µF/35V, 100µF/50V, 100µF/100V, 100µF/250V, 220µF/25V, 220µF/50V, 330µF/25V, 470µF/16V, 470µF/25V, 470µF/50V, 1000µF/16V

Order #	(kit)
102-027	\$42.99



Mylar Capacitor Assortment

Contains 200 short lead mylar capacitors. Voltages and values will vary. Voltages range from 50~630VDC. Values range from .001MFD~.47MFD.

Order #	(kit)
102-029	\$7.37



Capacitor Kits



Surface Mount Electrolytic Capacitor Kits

•SMD type electrolytic capacitors •Packed in a compartmentalized storage case

•#102-066 contains: 6.3V (3 each): 33µF, 47µF, 100µF, 220µF and (6 each) 22µF 10V (3 each): 22µF, 33µF, 47µF, 220µF and (6 each) 100µF

•#102-067 contains: 16V (3 each): 10µF, 22µF, 33µF, 47µF, 100µF and 220µF 25V (3 each): 4.7µF, 10µF, 22µF, 33µF, 47µF and 100µF

•#102-068 contains: 35V (3 each): 2.2µF, 3.3µF, 4.7µF, 6.8µF, 10µF and 22µF 50V (3 each): .10µF, .22µF, .33µF, .47µF, .68µF, 1µF, 2.2µF, 3.3µF, 4.7µF and 10µF

Order #	(kit)
102-066	\$34.87
102-067	34.87
102-068	36.40

Electrolytic Capacitor Assortment

Contains 75 radial and axial short lead electrolytic capacitors. Voltages and values will vary. Voltages range from 6.3V~50V. Values range from .1MFD~470MFD.



Order #	(kit)
102-030	\$7.37

Ceramic Disc Capacitor Assortment

200 short lead ceramic disc capacitors. Voltages and values will vary. Voltages range from 16~1000V. Values range from 1pF~.1MFD.



Order #	(kit)
102-028	\$7.48

Capacitor Kits



Ultra-Mini Electrolytic Capacitor Kits

•Ultra-mini radial electrolytic capacitors •Packed in a durable storage case •#102-063 contains: 6.3V (5 each): 10µF, 22µF, 33µF, 47µF, 100µF, 220µF and 330µF 10V (5 each): 22µF, 33µF, 47µF, 100µF and 220µF •#102-064 contains: 16V (5 each): 4.7µF, 10µF, 22µF, 33µF and 47µF 25V (5 each): 3.3µF, 4.7µF, 10µF, 22µF, 33µF, 47µF and 100µF •#102-065 contains: 35V (5 each): 2.2µF, 3.3µF, 4.7µF, 10µF, 22µF, 33µF and 47µF 50V (5 each): .1µF, .22µF, .33µF, .47µF, 1.0µF, 2.2µF, 3.3µF, 4.7µF, 10µF, 22µF and 33µF

Order #	(kit)
102-063	\$31.71
102-064	31.71
102-065	31.71



Capacitor Kits

Order your capacitors in kits for convenience and value. **Features:**

- Each kit contains the top 30 most popular voltages and values
- Cabinets stack together to build a component storage center
- One piece frame is lightweight and virtually unbreakable
- Keyhole slots for wall mounting
- Frame measures 9" W x 7 1/2" H x 6 1/2" D
- Contains 15 drawers, each divided in half
- All values are radial lead except where noted
- An asterisk denotes axial lead



Order #	Contents	(1-4)
High Voltage Aluminum Electrolytic		
CK-02	1 each of: 160V: 1.0, 2.2, 3.3, 4.7, 10, 22, 33, 47, 100*, 100µF; 250V: 1.0, 2.2, 3.3, 4.7, 10, 22, 33, 47µF; 350V: 1.0, 2.2, 3.3, 4.7*, 10, 33, 47, 100µF; 450V: 1.0, 4.7, 10*, 10µF	\$44.95
Non-Polarized Aluminum Electrolytic		
CK-03	2 each of: 25V: 4.7, 10µF; 50V: 1.0, 1.0*, 2.2, 2.2*, 3.3, 3.3*, 4.7, 4.7*, 10, 10*, 22, 22*, 47, 47* µF; 100V: 1.0*, 2.2, 2.2*, 3.3, 3.3*, 4.7, 4.7*, 10, 10*, 22*, 33, 33*, 47*, 100* µF	44.95
1000V Ceramic Disc		
CK-06	4 each of: 3.3, 5.0, 6.8, 10, 15, 18, 20, 22, 39, 47, 56, 68, 100, 150, 180, 220, 330, 470, 500, 560, 680, 1000, 1500, 2200, 4700, 5000, 10000, 47000, 50000, 100000pF	36.95
Mylar/Film		
CK-07	1 each of: 50V: .01, .1µF; 100V: .001, .01, .022, .033, .047, .1, .22, .47µF; 250V: .047, .1, .33, 1.0, 1.5µF; 400V: .01, .1µF; 630V: .001, .0033, .0047, .01, .015, .022, .047, .05, .068, .1, .15, .22, .47µF	47.95



Radial Dipped Tantalum Capacitors

- Sorry-no mixing of values for quantity pricing
- Sizes and color may vary by manufacturer
- Featuring quality manufacturers AVX, Kemet and Vishay



Order #	µF	(1-4)	(5-9)	(10-24)
50 Volts				
31-0600	.1	\$1.40	\$1.31	\$1.17
31-0610	.22	1.40	1.27	1.14
31-0620	.47	1.83	1.67	1.49
31-0625	.68	1.00	0.94	0.83
31-0635	1.5	2.33	2.18	1.95
31-0640	2.2	3.00	2.73	2.43
31-0645	3.3	3.67	3.33	2.97
31-0650	4.7	3.67	3.33	2.97
31-0655	6.8	5.67	5.30	4.73
35 Volts				
31-0665	15	5.67	5.56	5.39



High Temperature 105° C, Low ESR, High Frequency Radial Electrolytic Capacitor Kits

Don't miss the savings! Low ESR capacitors are now available in kits. Save a bundle when purchasing the kits versus the individual caps. Purchase the caps separately in 50V and your cost is \$76.27, but purchase the kit at \$37.50 and you'll save \$38.77! Each kit is packaged in a 15-compartment rugged case with an attached clip for convenient hanging/storage.

Order #	Voltage	Contents	(kit)
31-9590	6.3	5 each of 100, 150, 180, 220, 270 MFD 3 each of 330, 390, 470, 560, 680 MFD 2 each of 820, 1000, 1500, 2200 MFD	\$35.95
31-9595	10	5 each of 100, 150, 220, 270, 330 MFD 3 each of 390, 470, 560, 680, 820 MFD 2 each of 1000, 1500, 2200 MFD	37.95
31-9600	16	5 each of 47, 68, 100, 150, 220 MFD 3 each of 330, 470, 680, 1000 MFD 2 each of 1500, 2200 MFD	35.95
31-9605	25	5 each of 33, 47, 68, 100 MFD 3 each of 150, 220, 330 MFD 2 each of 470, 680, 820, 1000, 1500 MFD	35.95
31-9610	35	5 each of 22, 33, 47, 68 MFD 3 each of 100, 150, 220, 330, 470 MFD 1 each of 680, 820, 1000, 1500 MFD	35.95
31-9615	50	5 each of 1.0, 2.2, 3.3, 4.7, 10, 22, 33 MFD 3 each of 47, 68, 100, 150 MFD 2 each of 220, 330 MFD 1 each of 470, 1000 MFD	37.50
31-9620	63	5 each of 10, 15, 22, 33, 47 MFD 3 each of 68, 100, 150, 220, 330, 470 MFD	36.95
31-9625	100	5 each of 47, 1.0, 1.5, 2.2, 3.3, 4.7, 6.8, 10 MFD 3 each of 15, 22, 33, 39 MFD 2 each of 47, 100 MFD	36.95
31-9630	160	5 each of 1.0, 2.2, 3.3, 4.7, 10 MFD 3 each of 22, 33 MFD 2 each of 47, 68, 100 MFD	37.95
31-9635	200	5 each of 1.0, 2.2, 3.3, 4.7, 10 MFD 3 each of 22, 33 MFD 2 each of 47, 82 MFD	36.95
31-9640	250	5 each of 1.0, 2.2, 3.3, 4.7, 10 MFD 3 each of 15, 22, 33, 47 MFD 2 each of 47, 82 MFD	38.95
31-9645	350	5 each of 1.0, 2.2, 3.3, 4.7 MFD 3 each of 10, 22, 33, 47 MFD	37.95
31-9650	400/450	400V: 2 each of 1.0, 2.2, 3.3, 4.7 MFD 1 each of 10, 22 MFD 450V: 2 each of 1.0, 2.2, 3.3, 4.7 MFD 1 each of 10, 22 MFD	36.95

Electronics Pocket Reference (3rd Edition)

Filled with definitions, formulas, tables and diagrams that supply helpful solutions to electronic problems. 550 pages, soft cover.

Order #	(ea.)
81-3157	\$29.95

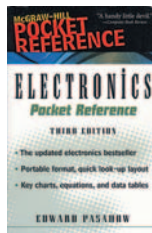

Semiconductors/Components



section 16



High Temperature 105° C Radial Electrolytic Capacitor Kits

Popular high-temperature capacitors are now available in kits for added convenience and savings! Purchase the caps separately in 6.3V and your cost is \$37.80, but purchase the kit at \$24.95 and you'll save \$12.85! Each kit is packaged in a 15-compartment rugged case with an attached clip for convenient hanging/storage. Capacitors are miniature, same size or smaller than 85°C radials.

Order #	Voltage	Contents	(kit)
31-9525	6.3	5 each of 47, 100, 220, 330, 470, 1000, 1500 µF 2 each of 2200, 3300, 4700 µF	\$24.95
31-9530	10	5 each of 47, 100, 220, 330, 470, 1000, 1500 µF 2 each of 2200, 3300 µF 1 each of 4700 µF	24.95
31-9535	16	5 each of 33, 47, 100, 220, 330, 470, 1000 µF 2 each of 1500, 2200 µF 1 each of 3300, 4700 µF	24.95
31-9540	25	5 each of 10, 22, 33, 47, 100, 220, 330, 470 µF 2 each of 1000, 1500 µF 1 each of 2200 µF	24.95
31-9545	35	5 each of 4.7, 10, 22, 33, 47, 100, 220, 330 µF 2 each of 470, 1000 µF 1 each of 2200 µF	24.95
31-9550	50	5 each of .1, .22, .33, .47, 1.0, 2.2, 3.3, 4.7, 10, 22, 33, 47, 100 µF 2 each of 220 µF	24.95
31-9555	63	5 each of 10, 22, 33, 47, 100, 220, 330 µF 2 each of 470, 1000 µF	24.95
31-9560	100	5 each of .1, .22, .33, .47, 1.0, 2.2, 3.3, 4.7, 10 µF 3 each of 22, 33, 47, 100 µF	24.95
31-9565	160	5 each of .47, 1.0, 2.2, 3.3, 4.7, 10 µF 3 each of 22, 33 µF 2 each of 47, 100 µF	24.95
31-9570	200	5 each of .47, 1.0, 2.2, 3.3, 4.7, 10 µF 3 each of 22, 33 µF 2 each of 47, 100 µF	24.95
31-9575	250	5 each of .47, 1.0, 2.2, 3.3, 4.7 µF 2 each of 10, 22, 33, 47, 100 µF	24.95
31-9580	350	5 each of .47, 1.0, 2.2 µF 3 each of 3.3, 4.7 µF 2 each of 10, 22, 33 µF	24.95
31-9585	450	5 each of 1.0, 2.2 µF 2 each of 3.3, 4.7 µF 1 each of 10, 22, 33 µF	24.95



Order Toll Free 1-800-543-4330 Fax 1-800-765-6960 355

These high-quality electrolytic capacitors are excellent for use in repair, experimentation and prototype development. All capacitors are supplied by quality manufacturers Nichicon, United Chemicon or Panasonic. Capacitors are rated 85°C and 20% tolerance. Sorry-no mixing of values for quantity pricing.

Radial Electrolytic Capacitors



Order #	µF	(1-4)	(5-9)	(10-24)
10 Volts				
31-8315	47	\$0.41	\$0.38	\$0.33
31-8320	100	0.32	0.30	0.26
31-8325	220	0.43	0.40	0.35
16 Volts				
31-0355	0.47	1.20	1.09	0.95
31-0365	1	0.68	0.63	0.55
31-0375	2.2	1.20	1.09	0.95
31-0385	3.3	1.20	1.09	0.95
31-0395	4.7	0.98	0.91	0.79
31-0115	10	0.34	0.31	0.28
31-025	22	0.34	0.31	0.28
31-035	33	0.41	0.37	0.33
31-045	47	0.41	0.37	0.33
31-055	100	0.41	0.37	0.33
31-065	220	0.61	0.57	0.49
31-075	330	0.68	0.63	0.55
31-085	470	0.85	0.78	0.69
31-095	1000	0.98	0.91	0.79
31-105	2200	1.50	1.36	1.18
31-115	3300	1.80	1.62	1.39
31-125	4700	2.25	2.02	1.73
25 Volts				
31-0405	.47	1.20	1.09	0.95
31-0415	1	0.72	0.66	0.59
31-0425	2.2	1.20	1.09	0.95
31-0435	3.3	1.20	1.09	0.95
31-0445	4.7	0.41	0.37	0.33
31-135	10	0.41	0.37	0.33
31-145	22	0.34	0.31	0.28
31-155	33	0.41	0.37	0.33
31-165	47	0.41	0.37	0.33
31-175	100	0.27	0.25	0.22
31-185	220	0.68	0.63	0.55
31-195	330	0.68	0.63	0.55
31-205	470	0.98	0.91	0.79
31-215	1000	1.08	0.98	0.85
31-225	2200	1.40	1.26	1.08
31-235	3300	2.76	2.44	2.17

Order #	µF	(1-4)	(5-9)	(10-24)
25 Volts				
31-245	4700	\$3.00	\$2.66	\$2.37
31-5105	6800	3.80	3.44	3.13
31-5110	8200	5.14	4.52	4.11
31-5115	10000	6.79	6.29	5.73
35 Volts				
31-0455	.47	1.20	1.09	0.95
31-0465	1	1.20	1.09	0.95
31-0475	2.2	0.98	0.91	0.79
31-0485	3.3	0.68	0.63	0.55
31-0495	4.7	0.34	0.31	0.28
31-255	10	0.34	0.31	0.28
31-265	22	0.41	0.37	0.33
31-275	33	0.41	0.37	0.33
31-285	47	0.62	0.37	0.33
31-295	100	0.47	0.44	0.38
31-305	220	0.68	0.63	0.55
31-315	330	0.91	0.84	0.74
31-325	470	1.08	0.98	0.85
31-335	1000	1.20	1.09	0.95
31-345	2200	1.75	1.57	1.35
31-355	3300	3.16	2.83	2.58
31-365	4700	3.36	3.01	2.74
31-5120	6800	4.54	4.11	3.74
31-5125	8200	5.53	4.98	4.53
31-5130	10000	8.33	7.72	7.02
50 Volts				
31-375	.47	0.27	0.25	0.22
31-385	1	0.27	0.25	0.22
31-395	2.2	0.27	0.25	0.22
31-405	3.3	0.27	0.25	0.22
31-415	4.7	0.27	0.25	0.22
31-0570	6.8	0.47	0.44	0.38
31-425	10	0.27	0.25	0.22
31-435	22	0.34	0.31	0.28
31-445	33	0.34	0.31	0.28
31-455	47	0.27	0.25	0.22
31-465	100	0.41	0.37	0.33
31-475	220	0.78	0.72	0.64
31-485	330	0.98	0.91	0.79
31-505	1000	1.50	1.35	1.15
31-515	2200	2.20	1.95	1.73
31-525	3300	4.31	3.91	3.55
31-535	4700	4.13	3.74	3.40
31-540	6800	5.60	5.19	4.73
63 Volts				
31-4960	4.7	0.34	0.31	0.28
31-4965	10	0.26	0.24	0.22

Order #	µF	(1-4)	(5-9)	(10-24)
63 Volts				
31-4970	22	\$0.30	\$0.28	\$0.25
31-4975	33	0.32	0.30	0.26
31-4980	47	0.41	0.38	0.33
31-4985	100	0.50	0.46	0.41
31-4990	150	1.14	1.00	0.87
31-4995	220	0.75	0.68	0.59
31-5000	330	0.95	0.85	0.73
31-5005	470	1.50	1.35	1.15
31-5010	680	2.60	2.31	2.05
31-5015	1000	2.75	2.46	2.25
31-5020	1500	4.50	3.96	3.60
31-5025	2200	4.40	3.99	3.63
100 Volts				
31-1005	.47	0.34	0.31	0.28
31-1015	1	0.34	0.31	0.28
31-1025	2.2	0.41	0.37	0.33
31-1035	3.3	0.47	0.44	0.38
31-1045	4.7	0.47	0.44	0.38
31-1055	10	0.61	0.57	0.49
31-1065	22	0.68	0.63	0.55
31-1075	33	0.91	0.84	0.74
31-1085	47	0.85	0.78	0.69
31-1095	100	0.98	0.91	0.79
31-1105	220	2.40	2.12	1.90
31-1115	330	3.16	2.83	2.58
31-1125	470	2.20	1.95	1.73
31-1135	1000	3.56	3.18	2.89
160 Volts				
31-1330	1	0.61	0.57	0.49
31-1335	2.2	0.61	0.57	0.49
31-1340	3.3	0.61	0.57	0.49
31-1345	4.7	0.68	0.63	0.55
31-1350	6.8	0.85	0.76	0.67
31-1355	10	0.68	0.63	0.55
31-1360	22	1.50	1.36	1.18
31-1365	33	1.50	1.35	1.15
31-1370	47	1.44	1.31	1.13
31-3860	100	1.50	1.36	1.18
31-3855	220	3.56	3.18	2.89
31-5135	330	4.50	3.96	3.60
31-5140	470	5.50	5.10	4.64
200 Volts				
31-5030	1	0.54	0.49	0.43
31-5035	2.2	0.54	0.50	0.44
31-5040	3.3	0.68	0.63	0.55
31-5045	4.7	0.72	0.66	0.59
31-5050	10	0.85	0.78	0.69

Order #	µF	(1-4)	(5-9)	(10-24)
200 Volts				
31-5060	22	\$0.91	\$0.84	\$0.74
31-5065	33	1.38	1.25	1.09
31-5070	47	1.50	1.36	1.18
31-3370	50	1.50	1.35	1.15
31-5075	68	2.04	1.75	1.56
31-5080	100	2.28	2.02	1.80
31-5085	150	3.48	3.02	2.75
31-5090	220	4.50	4.08	3.71
31-5095	330	5.60	5.19	4.73
31-5100	470	6.83	6.32	5.76
250 Volts				
31-1380	1	0.61	0.57	0.49
31-1385	2.2	0.61	0.57	0.49
31-1390	3.3	0.68	0.63	0.55
31-1395	4.7	0.97	0.83	0.70
31-1400	6.8	0.85	0.78	0.69
31-1405	10	0.85	0.78	0.69
31-1410	22	0.85	0.78	0.69
31-1415	33	1.50	1.36	1.18
31-1420	47	1.50	1.36	1.18
31-1885	100	2.64	2.34	2.08
31-1895	220	3.91	3.50	3.19
31-1905	330	3.95	3.54	3.22
350 Volts				
31-1635	.47	1.20	1.09	0.95
31-1640	1	1.20	1.09	0.95
31-1645	2.2	1.20	1.09	0.95
31-1650	3.3	0.89	0.87	0.85
31-1655	4.7	1.32	1.19	1.04
31-1660	10	1.20	1.09	0.95
31-1665	22	2.21	2.04	1.86
31-1670	33	1.40	1.26	1.08
31-1675	47	1.75	1.57	1.35
31-1960	100	6.13	5.68	5.17
31-1970	220	7.70	6.93	6.31
450 Volts				
31-1680	1	0.68	0.63	0.55
31-1685	2.2	0.78	0.70	0.62
31-3850	3.3	1.32	1.19	1.04
31-1690	4.7	0.96	0.87	0.75
31-1695	10	1.30	1.16	1.00
31-3945	22	3.00	2.58	2.30
31-3845	33	5.60	5.19	4.73
31-2000	47	4.50	4.08	3.71
31-2005	100	5.78	5.36	4.87
31-2010	220	8.93	8.27	7.53
31-2015	330	10.50	9.73	8.86

Axial Electrolytic Capacitors



Order #	µF	(1-4)	(5-9)	(10-24)
16 Volts				
31-0360	1	\$1.20	\$1.06	\$0.92
31-0390	4.7	0.68	0.61	0.53
31-010	10	0.68	0.63	0.55
31-020	22	0.72	0.66	0.59
31-030	33	0.61	0.55	0.48
31-040	47	0.54	0.50	0.44
31-050	100	0.85	0.78	0.69
31-060	220	0.54	0.50	0.44
31-080	470	1.20	1.09	0.95
31-090	1000	1.44	1.31	1.13
31-100	2200	1.50	1.35	1.15
31-120	4700	2.76	2.44	2.17
25 Volts				
31-0410	1	1.20	1.09	0.95
31-0420	2.2	0.96	0.87	0.75
31-0440	4.7	0.68	0.63	0.55
31-130	10	0.68	0.63	0.55
31-140	22	0.54	0.50	0.44

Order #	µF	(1-4)	(5-9)	(10-24)
25 Volts				
31-150	33	\$0.68	\$0.63	\$0.55
31-160	47	0.41	0.37	0.33
31-170	100	0.96	0.87	0.75
31-180	220	0.54	0.49	0.43
31-190	330	0.99	0.95	0.79
31-200	470	1.50	1.35	1.15
31-210	1000	2.25	2.02	1.73
31-220	2200	2.25	2.02	1.73
31-230	3300	3.59	3.13	2.85
31-240	4700	3.56	3.18	2.89
35 Volts				
31-0460	1	1.20	1.09	0.95
31-0490	4.7	0.68	0.63	0.55
31-250	10	0.68	0.63	0.55
31-260	22	0.68	0.63	0.55
31-270	33	0.68	0.61	0.53
31-280	47	0.85	0.78	0.69
31-290	100	0.85	0.76	0.67
31-300	220	0.96	0.84	0.73
31-310	330	1.08	0.98	0.85
31-320	470	1.45	1.30	1.11
31-330	1000	1.80	1.62	1.39
31-340	2200	3.16	2.83	2.58
31-350	3300	3.91	3.40	3.10
31-360	4700	4.88	4.29	3.90

High Temperature 105°C Radial Electrolytic Capacitors

• Miniature, same size or smaller than standard temperature radial electrolytics
• These high temperature capacitors are suitable for many consumer and industrial applications
• All capacitors are supplied by quality manufacturers: Nichicon, United Chemicon and Panasonic

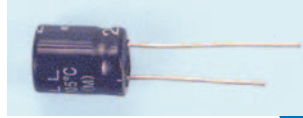

Order #	µF	(1-4)	(5-9)	(10-24)
6.3 Volts				
31-6720	22	\$0.78	\$0.72	\$0.64
31-6725	33	0.78	0.70	0.62
31-6730	47	0.78	0.72	0.64
31-6735	68	0.78	0.72	0.64
31-6740	100	0.55	0.52	0.45
31-6745	150	0.91	0.84	0.74
31-6750	220	0.60	0.54	0.48
31-6755	330	0.65	0.59	0.51
31-6760	470	0.70	0.64	0.56
31-6765	680	1.26	1.23	1.20
31-6770	1000	0.95	0.87	0.75
31-6775	1500	1.55	1.39	1.18
31-6780	2200	1.25	1.12	0.97
31-6785	3300	1.50	1.43	1.24
31-6790	4700	1.70	1.49	1.34
31-6795	6800	2.55	2.29	2.08
31-6800	10000	3.30	2.99	2.72
31-6805	15000	4.25	3.83	3.48
31-6810	22000	5.50	5.10	4.64
31-6815	33000	7.53	6.77	6.15
10 Volts				
31-6820	10	0.78	0.72	0.64
31-6830	22	0.78	0.72	0.64
31-6835	33	0.78	0.72	0.64
31-6840	47	0.78	0.72	0.64
31-6845	68	0.85	0.75	0.67
31-6850	100	0.60	0.56	0.49
31-6855	150	0.98	0.88	0.77
31-6860	220	0.60	0.55	0.47
31-6865	330	0.70	0.64	0.56
31-6870	470	0.80	0.72	0.63
31-6875	680	1.50	1.32	1.15
31-6880	1000	0.95	0.85	0.73
31-6885	1500	1.80	1.62	1.39
31-6890	2200	1.45	1.29	1.11
1-6895	3300	1.50	1.42	1.26
31-6900	4700	2.20	1.95	1.73
31-6905	6800	3.05	2.65	2.41
31-6910	10000	4.10	3.51	3.28
31-6915	15000	5.00	4.50	4.10
31-6920	22000	7.53	7.38	7.15
16 Volts				
31-6925	4.7	0.78	0.72	0.64
31-6930	6.8	0.78	0.76	0.74
31-6935	10	0.78	0.72	0.64
31-6940	15	0.78	0.76	0.74
31-6945	22	0.78	0.72	0.64
31-6950	33	0.78	0.72	0.64
31-6955	47	0.55	0.52	0.45
31-6960	68	0.85	0.76	0.67
31-6965	100	0.60	0.56	0.49
31-6970	150	1.02	0.90	0.78
31-6975	220	0.70	0.64	0.56
31-6980	330	0.80	0.72	0.63
31-6985	470	0.90	0.81	0.71
31-6990	680	1.40	1.26	1.08
31-6995	1000	1.15	1.03	0.89
31-7000	1500	1.90	1.70	1.46
31-7005	2200	1.65	1.48	1.27
31-7010	3300	2.00	1.77	1.58
31-7015	4700	2.60	2.33	2.12
31-7020	6800	3.45	3.13	2.84
31-7025	10000	5.00	4.64	4.22
31-7030	15000	6.79	6.11	5.56
25 Volts				
31-7035	3.3	0.78	0.72	0.64
31-7040	4.7	0.78	0.72	0.64
31-7045	6.8	0.78	0.70	0.62
31-7050	10	0.78	0.72	0.64
31-7055	15	0.85	0.78	0.69
31-7060	22	0.85	0.78	0.69

Order #	µF	(1-4)	(5-9)	(10-24)
25 Volts				
31-7065	33	\$0.91	\$0.84	\$0.74
31-7070	47	0.55	0.52	0.45
31-7075	68	0.98	0.88	0.77
31-7080	100	0.70	0.64	0.56
31-7090	220	0.85	0.77	0.67
31-7095	330	0.90	0.81	0.71
31-7100	470	1.05	0.94	0.81
31-7105	680	1.80	1.62	1.39
31-7110	1000	1.50	1.35	1.15
31-7115	1500	2.08	1.84	1.64
31-7120	2200	2.00	1.77	1.58
31-7125	3300	2.70	2.42	2.20
31-7130	4700	4.10	3.62	3.38
31-7135	6800	5.40	5.01	4.55
31-7140	10000	7.53	6.97	6.34
35 Volts				
31-7145	2.2	0.78	0.72	0.64
31-7150	3.3	0.78	0.72	0.64
31-7155	4.7	0.78	0.72	0.64
31-7160	6.8	0.85	0.76	0.67
31-7165	10	0.85	0.78	0.69
31-7170	15	0.91	0.82	0.72
31-7175	22	0.98	0.91	0.79
31-7180	33	0.60	0.55	0.47
31-7185	47	0.70	0.64	0.56
31-7190	68	1.14	1.03	0.90
31-7195	100	0.80	0.72	0.63
31-7200	150	1.32	1.19	1.04
31-7205	220	1.00	0.91	0.79
31-7210	330	1.00	0.90	0.77
31-7215	470	1.20	1.07	0.93
31-7220	680	1.95	1.75	1.50
31-7225	1000	1.80	1.62	1.39
31-7230	1500	2.88	2.55	2.27
31-7235	2200	2.80	2.51	2.29
31-7240	3300	3.95	3.58	3.25
31-7245	4700	5.25	4.87	4.43
31-7250	6800	7.18	6.65	6.06
50 Volts				
31-7255	.1	0.50	0.46	0.41
31-7260	.22	0.55	0.52	0.45
31-7265	.33	0.55	0.52	0.45
31-7270	.47	0.55	0.52	0.45
31-7275	.56	0.78	0.70	0.62
31-7280	.68	0.78	0.70	0.62
31-7285	1	0.55	0.52	0.45
31-7290	1.5	0.78	0.72	0.64
31-7295	2.2	0.55	0.52	0.45
31-7300	3.3	0.55	0.52	0.45
31-7305	4.7	0.58	0.54	0.47
31-7310	6.8	0.85	0.76	0.67
31-7315	10	0.60	0.56	0.49
31-7320	15	0.98	0.91	0.79
31-7325	22	0.65	0.59	0.52
31-7330	33	0.70	0.64	0.56
31-7335	47	0.78	0.71	0.62
31-7340	68	1.26	1.11	0.96
31-7345	100	0.90	0.81	0.71
31-7350	150	1.44	1.27	1.10
31-7355	220	1.05	0.94	0.81
31-7360	330	1.20	1.07	0.93
31-7365	470	1.60	1.43	1.24
31-7370	680	2.08	1.84	1.64
31-7375	1000	2.50	2.32	2.11
31-7380	1500	4.50	4.07	3.71
31-7385	2200	4.40	4.08	3.60
31-7390	3300	5.70	5.28	4.81
31-7395	4700	7.70	7.14	6.50
63 Volts				
31-7400	6.8	0.85	0.78	0.69
31-7405	10	0.55	0.52	0.45

Order #	µF	(1-4)	(5-9)	(10-24)
63 Volts				
31-7410	15	\$0.91	\$0.84	\$0.74
31-7415	22	0.65	0.61	0.53
31-7420	33	0.70	0.64	0.56
31-7425	47	0.78	0.71	0.62
31-7430	68	1.26	1.11	0.96
31-7435	100	0.95	0.87	0.75
31-7440	150	1.44	1.27	1.10
31-7445	220	1.15	1.03	0.89
31-7450	330	1.35	1.21	1.04
31-7455	470	1.75	1.57	1.35
31-7460	680	2.28	1.96	1.75
31-7465	1000	2.90	2.60	2.37
31-7470	1500	4.50	3.96	3.60
31-7475	2200	5.35	4.96	4.51
31-7480	3300	6.75	6.26	5.70
31-7485	4700	7.70	7.14	6.50
100 Volts				
31-7490	.47	0.50	0.46	0.41
31-7495	.56	0.78	0.70	0.62
31-7500	.68	0.78	0.72	0.64
31-7505	1	0.50	0.46	0.41
31-7510	1.5	0.78	0.72	0.64
31-7515	2.2	0.55	0.52	0.45
31-7520	3.3	0.60	0.56	0.49
31-7525	4.7	0.60	0.55	0.47
31-7530	6.8	1.02	0.90	0.78
31-7535	10	0.70	0.64	0.56
31-7540	15	1.20	1.09	0.95
31-7545	22	0.85	0.77	0.67
31-7550	33	0.95	0.85	0.73
31-7555	47	1.05	0.94	0.81
31-7560	68	1.60	1.43	1.24
31-7565	100	1.45	1.29	1.12
31-7570	150	3.24	2.82	2.56
31-7575	220	2.55	2.38	2.16
31-7580	330	3.20	2.90	2.63
31-7585	470	4.00	3.63	3.30
31-7590	680	5.54	5.22	4.76
31-7595	1000	6.15	5.71	5.19
160 Volts				
31-7600	.47	0.78	0.70	0.62
31-7615	1	0.70	0.65	0.57
31-7625	2.2	0.75	0.68	0.59
31-7630	3.3	0.80	0.72	0.63
31-7635	4.7	0.90	0.81	0.71
31-7640	6.8	1.32	1.16	1.01
31-7645	10	1.05	0.95	0.82
31-7650	15	1.35	1.17	1.01
31-7655	22	1.25	1.12	0.97
31-7660	33	1.50	1.35	1.15
31-7665	47	1.90	1.70	1.46
31-7670	68	2.28	1.96	1.75
31-7675	100	2.35	2.08	1.85
31-7680	150	3.91	3.50	3.19
31-7685	220	3.80	3.44	3.13
31-7690	330	5.15	4.53	4.12
31-7695	470	5.81	5.23	4.76
200 Volts				
31-7700	.47	0.85	0.76	0.67
31-7705	.56	0.91	0.89	0.86
31-7710	.68	0.91	0.82	0.72
31-7715	1	0.98	0.91	0.79
31-7720	1.5	1.02	0.90	0.78
31-7725	2.2	1.08	0.98	0.85
31-7730	3.3	1.14	1.00	0.87
31-7735	4.7	1.26	1.14	0.99
31-7740	6.8	1.44	1.41	1.37
31-7745	10	1.50	1.36	1.18
31-7750	15	1.50	1.22	1.05
31-7755	22	1.55	1.39	1.19

Order #	µF	(1-4)	(5-9)	(10-24)
200 Volts				
31-7760	33	\$2.05	\$1.83	\$1.58
31-7765	47	2.40	2.15	1.85
31-7770	68	2.60	2.24	1.99
31-7775	100	3.20	2.86	2.61
31-7780	150	4.13	3.63	3.30
31-7785	220	5.21	4.73	4.30
31-7790	330	6.09	5.64	5.14
31-7795	470	6.97	6.46	5.87
250 Volts				
31-7800	.47	0.91	0.84	0.74
31-7815	1	0.75	0.68	0.59
31-7820	1.5	1.08	0.95	0.83
31-7825	2.2	0.85	0.77	0.67
31-7830	3.3	0.90	0.81	

Very Low Equivalent Series Resistance (ESR)/ High Temperature 105°C/High Frequency Radial Electrolytic Capacitors

- Ideal for switching power supplies, computer monitors and all applications where high ripple regularly occur
- Extremely low impedance, high reliability
- All capacitors are supplied by quality manufacturers: Nichicon, United Chemicon and Panasonic

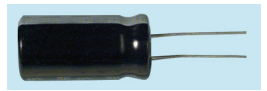

Order #	µF	(1-4)	(5-9)	(10-24)
6.3 Volts				
31-5155	100	\$1.14	\$1.00	\$0.87
31-5160	120	1.26	1.11	0.96
31-5165	150	1.32	1.16	1.01
31-5175	220	1.44	1.31	1.13
31-5180	270	1.50	1.36	1.18
31-5185	330	1.35	1.21	1.04
31-5195	470	1.50	1.35	1.15
31-5200	560	1.55	1.35	1.16
31-5205	680	1.65	1.62	1.57
31-5210	820	1.80	1.57	1.35
31-5215	1000	1.90	1.70	1.46
31-5220	1200	2.20	1.97	1.70
31-5225	1500	2.35	2.10	1.81
31-5230	1800	2.08	1.84	1.64
31-5235	2200	2.24	1.99	1.76
31-5240	2700	2.60	2.31	2.05
31-5245	3300	2.80	2.48	2.20
31-5250	3900	3.36	3.01	2.74
31-5255	4700	3.59	3.22	2.94
31-5260	5600	4.84	4.39	3.99
10 Volts				
31-5265	68	1.14	1.00	0.87
31-5275	100	1.38	1.25	1.09
31-5280	120	1.50	1.32	1.15
31-5285	150	1.40	1.37	1.33
31-5295	220	1.50	1.31	1.12
31-5305	330	1.55	1.35	1.16
31-5315	470	1.70	1.52	1.31
31-5320	560	1.75	1.52	1.31
31-5325	680	1.90	1.65	1.42
31-5330	820	1.95	1.70	1.46
31-5335	1000	2.10	1.88	1.62
31-5340	1200	2.50	2.25	1.93
31-5345	1500	2.20	1.95	1.73
31-5350	1800	2.40	2.12	1.90
31-5355	2200	2.56	2.27	2.02
31-5360	2700	3.00	2.58	2.30
31-5365	3300	3.32	2.98	2.71
31-5370	3900	3.79	3.30	3.00
31-5375	4700	4.05	3.56	3.24
16 Volts				
31-5380	47	1.14	1.03	0.90
31-5385	56	1.14	1.00	0.87
31-5390	68	1.14	1.12	1.08
31-5395	82	1.38	1.21	1.06
31-5400	100	1.50	1.36	1.18
31-5405	120	1.30	1.13	0.97
31-5410	150	1.50	1.35	1.15
31-5415	180	1.55	1.39	1.19
31-5420	220	1.65	1.48	1.27
31-5425	270	1.70	1.48	1.27
31-5430	330	1.70	1.48	1.27
31-5435	390	1.80	1.76	1.71
31-5440	470	1.85	1.66	1.42
31-5445	560	2.00	1.74	1.50
31-5450	680	2.10	1.83	1.57
31-5455	820	2.20	1.91	1.65
31-5460	1000	2.35	2.10	1.81
31-5465	1200	2.12	1.87	1.67
31-5470	1500	2.32	2.06	1.83
31-5475	1800	2.52	2.24	1.99
31-5480	2200	2.80	2.48	2.20
31-5485	2700	3.48	3.02	2.75
31-5490	3300	3.91	3.50	3.19
31-5495	3900	4.05	3.56	3.24
25 Volts				
31-5500	33	1.26	1.14	0.99
31-5505	39	1.26	1.11	0.96
31-5510	47	1.38	1.25	1.09
31-5515	56	1.38	1.21	1.06
31-5520	68	1.44	1.27	1.10
31-5525	82	1.50	1.47	1.43

Order #	µF	(1-4)	(5-9)	(10-24)
25 Volts				
31-5530	100	\$1.35	\$1.21	\$1.04
31-5540	150	1.55	1.39	1.19
31-5545	180	1.70	1.48	1.27
31-5550	220	1.75	1.57	1.35
31-5555	270	1.80	1.57	1.35
31-5560	330	1.90	1.70	1.46
31-5570	470	2.15	1.93	1.66
31-5575	560	2.12	1.87	1.67
31-5580	680	2.24	1.99	1.76
31-5585	820	0.48	0.46	0.43
31-5590	1000	2.64	2.34	2.08
31-5595	1200	2.84	2.51	2.24
31-5600	1500	3.00	2.61	2.38
31-5605	1800	3.16	2.75	2.50
31-5610	2200	3.24	2.90	2.64
31-5620	3300	4.69	4.25	3.86
35 Volts				
31-5625	22	1.26	1.14	0.99
31-5630	27	1.38	1.25	1.09
31-5635	33	1.38	1.25	1.09
31-5640	39	1.50	1.47	1.43
31-5645	47	1.35	1.21	1.04
31-5650	56	1.40	1.22	1.05
31-5655	68	1.45	1.30	1.11
31-5665	100	1.65	1.48	1.27
31-5670	120	1.75	1.52	1.31
31-5680	180	1.90	1.70	1.46
31-5685	220	2.00	1.79	1.54
31-5690	270	2.10	1.83	1.57
31-5695	330	2.25	2.02	1.73
31-5700	390	2.45	2.13	1.83
31-5705	470	2.08	1.84	1.64
31-5710	560	2.32	2.06	1.83
31-5715	680	2.48	2.13	1.90
31-5720	820	2.68	2.63	2.55
31-5725	1000	2.88	2.55	2.27
31-5730	1200	3.56	3.49	3.38
31-5735	1500	4.01	3.64	3.31
31-5745	2200	4.91	4.45	4.05
31-5750	2700	5.60	5.04	4.59
50 Volts				
31-5755	.47	1.08	0.98	0.85
31-5760	.68	1.08	0.98	0.85
31-5765	1	1.08	0.98	0.85
31-5770	1.5	1.08	0.98	0.85
31-5775	2.2	1.08	0.98	0.85
31-5780	3.3	1.08	0.98	0.85
31-5785	4.7	1.14	1.03	0.90
31-5790	6.8	1.14	1.00	0.87
31-0735	10	0.68	0.63	0.55
31-5795	12	1.20	1.06	0.92
31-5800	15	1.26	1.14	0.99
31-5805	18	1.38	1.21	1.06
31-0740	22	1.20	1.09	0.95
31-5810	27	1.50	1.36	1.18
31-5815	33	1.35	1.21	1.04
31-5820	39	1.50	1.31	1.12
31-5825	47	1.60	1.43	1.24
31-5830	56	1.65	1.44	1.23
31-5835	68	1.80	1.62	1.39
31-5840	82	1.85	1.81	1.76
31-5845	100	1.95	1.75	1.50
31-5850	120	2.05	1.83	1.58
31-5855	150	2.15	1.93	1.66
31-5860	180	2.25	1.96	1.68
31-5865	220	2.35	2.10	1.81
31-5870	270	2.40	2.09	1.80
31-5875	330	2.04	1.80	1.61
31-5885	470	2.44	2.16	1.93
31-5890	560	2.88	2.55	2.27
31-5895	680	3.04	2.65	2.41

Order #	µF	(1-4)	(5-9)	(10-24)
50 Volts				
31-5900	820	\$3.91	\$3.40	\$3.10
31-5905	1000	4.50	4.08	3.71
31-5910	1200	5.51	5.40	5.23
31-5915	1500	5.78	5.20	4.73
31-5925	2200	7.70	7.14	6.50
31-5930	10	1.40	1.03	0.90
31-5940	15	1.32	1.19	1.04
31-5950	22	1.38	1.25	1.09
31-5955	27	1.50	1.32	1.15
31-5960	33	1.35	1.17	1.01
31-5965	39	1.50	1.35	1.15
31-5970	47	1.60	1.42	1.24
31-5980	68	1.80	1.76	1.71
31-5990	100	1.95	1.75	1.50
31-5995	120	2.05	1.83	1.58
31-6000	150	2.15	1.87	1.61
31-6010	220	2.35	2.10	1.81
31-6015	270	2.40	2.35	2.28
31-6020	330	2.04	1.80	1.61
31-6025	390	2.28	2.23	2.17
31-6030	470	2.48	2.19	1.96
31-6035	560	2.92	2.51	2.23
31-6040	680	3.08	2.68	2.44
31-6050	1000	4.65	4.21	3.83
31-6055	1200	5.78	5.20	4.73
31-6065	1800	7.53	6.97	6.34
80 Volts				
31-6070	4.7	1.20	1.06	0.92
31-6080	10	1.32	1.29	1.25
31-6085	12	1.44	1.41	1.37
31-6100	22	1.40	1.22	1.05
31-6120	47	2.00	1.79	1.54
31-6130	68	2.15	2.11	2.04
31-6140	100	2.04	1.75	1.56
31-6150	150	2.52	2.47	2.39
100 Volts				
31-6155	.47	1.08	0.98	0.85
31-6160	.68	1.08	0.95	0.83
31-6165	1	1.08	0.98	0.85
31-6170	1.5	1.08	0.95	0.83
31-6175	2.2	1.14	1.03	0.90
31-6180	3.3	1.26	1.14	0.99
31-6185	4.7	1.32	1.19	1.04
31-6190	6.8	1.44	1.41	1.37
31-6195	10	1.50	1.36	1.18
31-6205	15	1.50	1.35	1.15
31-6210	18	1.55	1.52	1.47
31-6215	22	1.65	1.44	1.23
31-6220	27	1.85	1.81	1.76
31-6225	33	2.00	1.74	1.50
31-6230	39	2.10	1.88	1.62
31-6235	47	2.25	2.02	1.73
31-6240	56	2.35	2.04	1.76
31-6245	68	2.40	2.35	2.28
31-6255	100	2.28	2.02	1.80
160 Volts				
31-6265	1	1.26	1.11	0.96
31-6270	1.5	1.26	1.11	0.96
31-6275	2.2	1.38	1.25	1.09
31-6280	3.3	1.30	1.13	0.97
31-6285	4.7	1.40	1.26	1.08
31-6290	6.8	1.50	1.47	1.43
31-6295	10	1.65	1.48	1.27
31-6300	12	1.75	1.72	1.66
31-6315	22	1.75	1.57	1.35
31-6320	27	2.20	1.89	1.68
31-6325	33	1.75	1.51	1.34
31-6330	39	2.60	2.24	1.99
31-6335	47	2.20	1.95	1.73

Order #	µF	(1-4)	(5-9)	(10-24)
160 Volts				
31-6345	68	\$2.70	\$2.35	\$2.14
31-6350	82	3.67	3.30	3.00
31-6355	100	3.15	2.82	2.56
200 Volts				
31-6360	1	1.32	1.16	1.01
31-6365	1.5	1.38	1.35	1.31
31-6370	2.2	1.44	1.27	1.10
31-6375	3.3	1.35	1.21	1.04
31-6380	4.7	1.50	1.35	1.15
31-6385	6.8	1.65	1.62	1.57
31-6390	10	1.80	1.62	1.39
31-6395	12	1.90	1.86	1.81
31-6405	18	2.25	2.21	2.14
31-6410	22	1.80		

Radial Metalized Polyester Film Capacitors (Mylar)

•Tolerance: ±10%

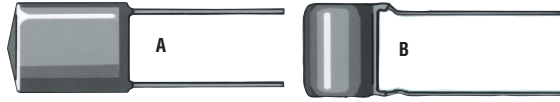

Fig. Order #	µF	(1-4)	(5-9)	(10-24)
100 Volts				
A 31-700	.001	\$0.25	\$0.21	\$0.18
A 31-710	.0015	0.25	0.21	0.18
A 31-720	.0022	0.25	0.21	0.18
A 31-730	.0033	0.32	0.28	0.24
A 31-740	.0047	0.39	0.35	0.30
A 31-750	.0068	0.45	0.44	0.42
A 31-750	.0068	0.25	0.21	0.18
A 31-7710	.0082	0.53	0.52	0.49
A 31-760	.01	0.42	0.41	0.39
A 31-770	.015	0.53	0.52	0.49
A 31-790	.022	0.42	0.41	0.39
A 31-800	.027	0.56	0.55	0.53
A 31-810	.033	0.42	0.41	0.39
A 31-820	.047	0.53	0.52	0.49
A 31-830	.056	0.56	0.55	0.53
A 31-840	.068	0.42	0.41	0.39
A 31-8715	.082	0.77	0.75	0.72
A 31-850	.1	0.53	0.52	0.49
A 31-860	.15	0.46	0.45	0.43
A 31-870	.22	0.63	0.62	0.59
A 31-880	.33	0.65	0.64	0.61
A 31-890	.47	1.05	1.03	0.98
A 31-8720	.56	1.33	1.31	1.24
A 31-8725	.68	1.54	1.51	1.43
A 31-8730	.82	2.10	2.06	1.96
A 31-8735	1	3.08	3.02	2.87
A 31-8740	1.5	3.43	3.37	3.19
A 31-8745	2.2	4.48	4.40	4.17
A 31-8750	2.7	5.46	5.36	5.09
A 31-8755	3.3	6.58	6.46	6.13
A 31-8760	4.7	7.88	7.72	7.34
250 Volts				
B 31-8765	.01	0.88	0.85	0.81
B 31-8770	.015	0.95	0.93	0.89

Fig. Order #	µF	(1-4)	(5-9)	(10-24)
250 Volts				
B 31-8775	.022	\$0.95	\$0.93	\$0.89
B 31-8780	.027	1.05	1.03	0.98
B 31-8785	.033	1.05	1.03	0.98
B 31-8790	.047	1.05	1.03	0.98
B 31-8795	.056	1.05	1.03	0.98
B 31-8800	.068	1.05	1.03	0.98
B 31-8805	.082	1.05	1.03	0.98
B 31-8810	.1	1.05	1.03	0.98
B 31-8815	.15	1.09	1.06	1.01
B 31-8820	.22	1.16	1.13	1.08
B 31-8825	.33	1.26	1.24	1.17
B 31-8830	.47	0.46	0.44	0.42
B 31-8835	.56	1.58	1.54	1.47
B 31-8840	.68	2.07	2.03	1.93
B 31-8845	.82	2.70	2.65	2.51
B 31-0550	1	0.88	0.85	0.81
B 31-8850	1.5	5.50	5.39	5.12
B 31-8855	2.2	6.44	6.31	6.00
B 31-8860	2.7	6.93	6.80	6.46
B 31-8865	3.3	8.65	8.48	8.05
400 Volts				
B 31-8870	.01	1.05	1.03	0.98
B 31-8875	.015	1.09	1.06	1.01
B 31-8880	.022	1.16	1.13	1.08
B 31-8885	.027	1.26	1.24	1.17
B 31-8890	.033	1.26	1.24	1.17
B 31-8895	.047	1.33	1.31	1.24
B 31-8900	.056	1.33	1.31	1.24
B 31-8905	.068	1.37	1.34	1.28
B 31-8910	.082	1.37	1.34	1.28
B 31-8915	.1	1.47	1.44	1.37
B 31-8920	.15	1.54	1.51	1.43
B 31-8925	.22	1.58	1.54	1.47

Fig. Order #	µF	(1-4)	(5-9)	(10-24)
400 Volts				
B 31-8930	.33	\$1.93	\$1.88	\$1.79
B 31-8935	.47	2.28	2.24	2.12
B 31-8940	.56	2.70	2.65	2.51
B 31-8945	.68	3.08	3.02	2.87
B 31-8950	.82	4.03	3.94	3.75
B 31-8955	1	5.32	5.22	4.95
B 31-8960	1.5	6.55	6.42	6.10
B 31-8965	2.2	7.70	7.55	7.18
630 Volts				
B 31-8970	.001	0.70	0.67	0.63
B 31-8975	.0015	0.70	0.67	0.63
B 31-8980	.0022	0.70	0.67	0.63
B 31-8985	.0033	0.88	0.85	0.81
B 31-8990	.0047	0.88	0.85	0.81
B 31-8995	.0056	0.88	0.85	0.81
B 31-9000	.0068	0.95	0.93	0.89
B 31-9005	.0082	1.05	1.03	0.98
B 31-9010	.01	1.16	1.13	1.08
B 31-9015	.015	1.23	1.21	1.14
B 31-9020	.022	1.26	1.24	1.17
B 31-9025	.027	1.40	1.37	1.31
B 31-9030	.033	1.40	1.37	1.31
B 31-9035	.047	1.47	1.44	1.37
B 31-9040	.056	1.47	1.40	1.33
B 31-9045	.068	1.58	1.54	1.47
B 31-9050	.082	1.58	1.54	1.47
B 31-9055	.1	1.65	1.62	1.53
B 31-9060	.15	1.82	1.78	1.70
B 31-9065	.22	2.00	1.96	1.86
B 31-9070	.33	2.28	2.24	2.12
B 31-9075	.47	2.80	2.75	2.61
B 31-9080	.56	3.33	3.27	3.10
B 31-9085	.68	3.85	3.78	3.58
B 31-9090	.82	5.78	5.66	5.39
B 31-9095	1	6.79	6.66	6.32

Axial Polyester Film Capacitors (Mylar)

•Ideal for use in crossover networks, filtering DC blocking, coupling, general communications equipment (telephones), AC circuits, charging/discharging applications, lighting and ceiling fans/controls •10% tolerance •Sorry-no mixing of values for quantity pricing

Order #	µF	(1-4)	(5-9)	(10-24)
100 Volts				
31-9655	0.001	\$2.60	\$2.36	\$2.11
31-9660	0.0022	2.60	2.36	2.11
31-9665	0.0033	2.60	2.36	2.11
31-9670	0.0047	2.60	2.36	2.11
31-9675	0.01	2.60	2.36	2.11
31-9680	0.022	2.60	2.36	2.11
31-9685	0.033	2.70	2.45	2.19
31-9690	0.047	2.70	2.45	2.19
31-9695	0.068	2.70	2.45	2.19
31-9700	0.082	2.70	2.45	2.19
31-9705	0.1	2.83	2.58	2.30
31-9710	0.15	2.83	2.58	2.30
31-9715	0.22	2.83	2.58	2.30
31-9720	0.33	3.30	3.00	2.68
31-9725	0.39	3.50	3.18	2.84
31-9730	0.47	3.50	3.18	2.84
31-9735	0.68	3.50	3.18	2.84
31-9740	1	4.17	3.79	3.38
31-9745	1.5	4.53	4.12	3.68
31-9750	2.2	4.63	4.21	3.76
31-9755	2.7	4.80	4.36	3.89
31-9760	3.3	5.90	5.36	4.78
31-9765	3.9	6.13	5.58	4.97
31-9770	4.7	6.53	5.94	5.30
31-9775	5.6	7.10	6.45	5.76
31-9780	6.8	7.87	7.15	6.38
31-9785	8	9.83	8.94	7.97
31-9790	10	11.83	10.76	9.59
31-9795	12	14.00	12.73	11.35
31-9800	16	17.83	16.21	14.46
31-9805	20	23.27	21.15	18.86
150 Volt				
31-1700	1	4.99	4.77	4.33
250 Volt				
31-9810	0.01	2.93	2.67	2.38
31-9815	0.022	2.93	2.67	2.38
31-9820	0.033	2.93	2.67	2.38
31-9825	0.047	2.93	2.67	2.38
31-9830	0.068	2.93	2.67	2.38
31-9835	0.082	2.93	2.67	2.38

Order #	µF	(1-4)	(5-9)	(10-24)
250 Volts				
31-9840	0.1	\$3.07	\$2.79	\$2.49
31-9845	0.15	3.07	2.79	2.49
31-9850	0.22	3.17	2.88	2.57
31-9855	0.33	3.17	2.88	2.57
31-9860	0.39	3.17	2.88	2.57
31-9865	0.47	3.17	2.88	2.57
31-0280	0.5	3.99	3.64	3.24
31-9870	0.68	3.17	2.88	2.57
31-0285	1	2.49	2.33	2.12
31-0290	1.5	1.99	1.83	1.67
31-0295	2.2	4.19	3.79	3.38
31-0300	2.7	6.00	5.45	4.86
31-0305	3	6.00	5.45	4.86
31-1710	3.3	4.69	4.24	3.78
31-9875	3.9	9.87	8.97	8.00
31-0310	4	6.19	5.61	5.00
31-1715	4.7	10.50	9.55	8.51
31-0320	5.6	11.95	10.91	9.73
31-1720	6.8	13.25	12.06	10.76
31-0325	8	8.69	7.88	7.03
31-0330	10	3.59	3.24	2.89
31-0335	12	9.19	8.33	7.43
31-0340	16	9.47	8.61	7.68
400 Volts				
31-9880	0.01	3.17	2.88	2.57
31-9885	0.022	3.17	2.88	2.57
31-9890	0.033	3.17	2.88	2.57
31-9895	0.047	3.17	2.88	2.57
31-9900	0.068	3.17	2.88	2.57
31-9905	0.082	3.30	3.00	2.68
31-9910	0.1	3.30	3.00	2.68
31-9915	0.15	3.50	3.18	2.84
31-9920	0.22	3.50	3.18	2.84
31-9925	0.33	3.67	3.33	2.97
31-9930	0.39	3.83	3.48	3.11
31-9935	0.47	4.27	3.88	3.46
31-9940	0.68	4.50	4.09	3.65
31-9945	1	4.93	4.48	4.00
31-9950	1.5	6.17	5.61	5.00
31-9955	2.2	7.17	6.52	5.81

Order #	µF	(1-4)	(5-9)	(10-24)
400 Volts				
31-9960	2.7	\$8.60	\$7.82	\$6.97
31-9965	3.3	9.93	9.03	8.05
31-9970	3.9	12.27	11.15	9.95
31-9975	4.7	13.27	12.06	10.76
600 Volts				
31-9980	0.001	3.17	2.88	2.57
31-9985	0.0022	3.17	2.88	2.57
31-9990	0.0033	3.17	2.88	2.57
31-9995	0.0047	3.17	2.88</	

NEW

Motor Start Capacitors

•Provides the torque necessary to start AC motors and in other intermittent AC applications •50/60Hz

•Plastic case •Dimensions: 1 1/8" (D) x 2 1/2" (H), except #31-10180 and 31-10185 which are 1 1/8" (D) x 3" (H) •Don't see the value you need? We can provide all values. Please contact your friendly account representative to place a special order.



Order #	MFD	Industry No.	(1-4)	(5-9)
110-250V				
31-10060	21-25	11002	\$3.38	\$2.96
31-10065	25-30	11003	3.86	3.39
31-10070	30-36	11004	3.86	-
31-10075	36-43	11005	3.86	3.39
31-10080	43-53	11006	3.86	-
31-10085	47-56	-	4.20	3.68
31-10090	56-75	11007	4.20	3.68
31-10095	64-77	-	4.20	3.68
31-10100	72-88	11008	4.20	3.68
31-10105	88-108	11009	4.20	3.68
31-10110	108-130	11010	4.20	3.68
31-10115	124-149	11112	4.20	3.68
31-10120	130-156	-	4.20	3.68
31-10125	145-174	11013	4.20	3.68
31-10130	161-193	11014	4.20	3.68
31-10135	189-227	11015	4.20	3.68
220-250V				
31-10140	21-25	11038	5.46	4.79
31-10145	25-30	11039	5.76	5.05
31-10150	30-36	11040	5.76	5.05
31-10155	36-43	11041	5.76	5.05
31-10160	43-53	11042	6.16	5.40
31-10165	47-56	-	7.38	6.47
31-10170	53-64	11043	7.38	6.47
31-10175	64-77	-	7.72	6.77
31-10180	72-88	11044	7.72	6.77
31-10185	88-108	11045	7.72	6.77

NEW



Motor Run Capacitors

•Used in motor run, HVAC, lighting and power supply applications •50/60Hz •Single section •Metal case •Don't see the value you need? We can provide all values. Please contact your friendly account representative to place a special order.

Fig.	Order #	MFD	Case Style	Industry No.	(1-4)	(5-9)
370 Volt						
A	31-10190	2	Oval	12002	\$7.50	\$6.58
A	31-10195	3	Oval	12003	7.50	6.58
A	31-10200	4	Oval	12004	7.50	6.58
A	31-10205	5	Oval	12005	7.50	6.58
A	31-10210	6	Oval	12006	7.50	6.58
A	31-10215	7.5	Oval	12007	7.50	6.58
A	31-10220	10	Oval	12008	7.50	6.58
A	31-10225	15	Oval	12010	10.96	9.61
A	31-10230	25	Oval	12015	15.10	13.25
A	31-10235	30	Oval	12017	17.36	15.23
A	31-10240	35	Oval	12018	17.36	15.23
A	31-10245	40	Oval	12021	20.06	17.60
B	31-10250	5	Round	-	6.50	5.70
B	31-10255	10	Round	-	8.56	7.51
B	31-10260	15	Round	12210	11.40	10.00
B	31-10265	20	Round	12214	13.40	11.75
B	31-10270	25	Round	12215	16.10	14.12
B	31-10275	30	Round	12217	17.40	15.26
B	31-10280	35	Round	12218	17.64	15.47
B	31-10285	40	Round	12221	21.94	19.25
440 Volt						
A	31-10290	2	Oval	12026	9.26	8.12
A	31-10295	3	Oval	12027	9.26	8.12
A	31-10300	4	Oval	12028	9.26	8.12
A	31-10305	5	Oval	12029	9.26	8.12
A	31-10310	6	Oval	12030	10.02	8.79
A	31-10315	10	Oval	12032	10.22	8.96
A	31-10320	15	Oval	12034	14.56	12.77
A	31-10325	20	Oval	12037	16.70	14.65
A	31-10330	25	Oval	12040	19.44	17.05
A	31-10335	30	Oval	12041	19.44	17.05
A	31-10340	35	Oval	12043	20.04	17.58
A	31-10345	40	Oval	12045	23.60	20.70
B	31-10350	5	Round	-	7.70	6.75
B	31-10355	10	Round	12232	10.20	8.95
B	31-10360	15	Round	12234	16.80	14.74
B	31-10365	20	Round	12237	17.60	15.44
B	31-10370	25	Round	12240	18.70	16.40
B	31-10375	30	Round	12241	19.94	17.49
B	31-10380	35	Round	12243	20.14	17.67
B	31-10385	40	Round	12245	22.64	19.86

Memory Back-Up Capacitors

•Used in VCRs and other electronic equipment to maintain clock and other presets when power is removed from unit
•Radial •5.5V



Order #	Farad	(1-4)	(5-9)	(10-29)
31-0755	.047	\$4.13	\$3.74	\$3.40
31-8330	.1	4.99	4.59	3.99
31-0750	.22	5.99	5.49	4.99
31-8335	.33	6.99	6.39	5.89
31-8340	.47	7.99	7.49	6.99
31-0760	1.0	8.45	8.10	7.37



multicomp High-Temperature Axial Aluminum Electrolytic Capacitors (105°C)

High-temperature capacitors suitable for many consumer and industrial applications. •Operating temperature: -40°~+105°C •±20% tolerance

Order #	µF	Dia. x L. (mm)	(1-9)	(10-49)	(50-99)
16 Volts					
92N5437	100	6.3 x 14	\$0.50	\$0.36	\$0.27
92N5439	470	8 x 16	0.81	0.58	0.42
92N5440	1000	10 x 21	1.12	0.78	0.56
92N5441	2200	13 x 24	1.53	1.10	0.79
92N5442	4700	16 x 33	2.55	1.83	1.32
25 Volts					
92N5444	22	5 x 13	0.50	0.36	0.27
92N5445	47	6 x 13	0.55	0.40	0.29
92N5448	470	10 x 21	1.01	0.73	0.53
92N5449	1000	13 x 22	1.63	1.14	0.82
92N5450	2200	16 x 28	2.55	1.83	1.32
92N5451	4700	18 x 36	3.58	2.58	1.84
35 Volts					
92N5453	22	5 x 13	0.50	0.35	0.26
92N5455	100	8 x 16	3.06	2.14	1.54
92N5457	470	13 x 22	1.53	1.10	0.79
92N5458	1000	13 x 27	1.83	1.32	0.95
50 Volts					
92N5461	.47	6 x 12	0.55	0.39	0.28
92N5462	1.0	6 x 12	0.55	0.40	0.29
92N5463	2.2	6 x 12	0.55	0.40	0.29
92N5464	3.3	6 x 12	0.55	0.39	0.28
92N5465	10	6 x 12	0.55	0.40	0.29
92N5467	47	8 x 16	0.91	0.66	0.47
92N5468	100	10 x 17	0.91	0.64	0.46
92N5470	330	13 x 22	1.53	1.07	0.77
92N5471	470	16 x 28	1.63	1.17	0.84
63 Volts					
92N5473	10	6 x 13	0.55	0.39	0.28
92N5474	22	6.3 x 14	0.55	0.39	0.28
92N5476	100	10 x 17	1.01	0.73	0.53
92N5478	470	13 x 27	2.24	1.57	1.13
92N5479	1000	16 x 33	4.50	3.15	2.26
100 Volts					
92N5481	1.0	5 x 13	0.60	0.42	0.31
92N5482	2.2	5 x 13	0.60	0.42	0.31
92N5483	4.7	6 x 13	0.60	0.43	0.32
92N5484	10	6.3 x 14	0.60	0.43	0.32
92N5485	22	8 x 16	0.71	0.50	0.37
92N5486	47	10 x 21	1.22	0.88	0.64
92N5487	100	13 x 22	1.53	1.10	0.79

KEMET

Tantalum Electrolytic Capacitors

•T350 series •Operating temperature: -55°C~125°C •Tolerance: ±10% •Sorry-no mixing of values for quantity pricing



Order #	µF	Dia. x H.	(1-4)	(5-9)	(10-24)
16 Volts					
31-4310	10	.216" x .350"	\$0.53	\$0.53	\$0.50
31-4315	22	.236" x .390"	0.74	0.65	0.60
31-4330	100	.350" x .630"	4.17	3.74	3.31
20 Volts					
31-4345	47	.350" x .530"	1.92	1.86	1.65
31-4350	100	.400" x .670"	4.70	4.40	3.96
25 Volts					
31-4370	47	.350" x .530"	3.10	2.97	2.64
35 Volts					
31-4410	22	.350" x .530"	1.92	1.86	1.65
50 Volts					
31-4425	10	.350" x .530"	2.46	2.31	2.09

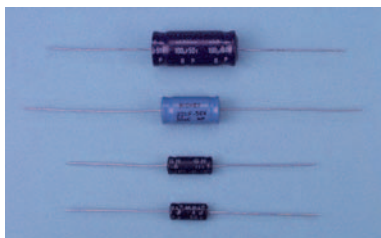

Nonpolarized Electrolytic Capacitors

•Ideal for crossover networks •Axial type •Sorry-no mixing of values for quantity pricing

Order #	µF	(1-4)	(5-9)	(10-24)
50 Volts				
31-580	.47	\$1.50	\$1.35	\$1.15
31-590	1.0	1.50	1.35	1.15
31-600	2.2	1.50	1.35	1.15
31-610	3.3	1.38	1.25	1.09
31-2025	4.0	1.32	1.19	1.04
31-620	4.7	1.80	1.62	1.39
31-2030	6.8	1.50	1.35	1.15
31-630	10.0	1.50	1.35	1.15
31-2035	14.0	1.65	1.48	1.27
31-640	22.0	2.00	1.79	1.54
31-650	33.0	2.35	2.04	1.76
31-660	47.0	1.60	1.43	1.24
31-2040	100.0	3.16	2.83	2.58
31-2045	200.0	3.48	3.11	2.83

Order #	µF	(1-4)	(5-9)	(10-24)
100 Volts				
31-1290	.47	\$1.80	\$1.62	\$1.39
31-1295	1.0	1.80	1.62	1.39
31-1300	2.2	1.80	1.62	1.39
31-1305	3.3	1.80	1.62	1.39
31-2050	4.0	2.20	1.95	1.73
31-1310	4.7	2.00	1.79	1.54
31-2055	6.8	2.15	1.93	1.66
31-1315	10.0	1.17	1.14	1.04
31-2060	14.0	2.10	1.88	1.62
31-1320	22.0	2.00	1.79	1.54
31-0685	33.0	2.25	2.02	1.73
31-0690	47.0	1.94	1.76	1.64
31-0695	80.0	2.03	1.96	1.72
31-2065	100.0	3.95	3.54	3.22
31-0700	125.0	3.48	3.11	2.83
31-0705	150.0	3.94	3.57	3.24
31-2070	200.0	7.18	6.65	6.06

Ultra Miniature Surface Mount Electrolytic Capacitors

•5mm high •Operating temperature: -40°C~+85°C •Ideal for use in compact portable electronics such as laptop computers, camcorders and cell phones •Mfr: Nichicon •Some values available in 3mm diameter, call your MCM account representative to special order



Ultra Miniature Radial Electrolytic Capacitors

•5mm high •Operating temperature: -40°C~+85°C •Ideal for replacement in portable electronics applications •Mfr: Nichicon

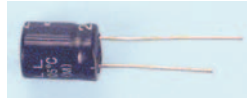

Order #	µF	Diameter (mm)	(1-4)	(5-9)	(10-24)
4 Volts					
31-8600	22	3	\$0.79	\$0.77	\$0.73
31-8150	33	4	0.79	0.75	0.71
31-8155	47	4	0.79	0.75	0.71
31-8605	56	5	0.79	0.77	0.73
31-8160	100	5	0.79	0.77	0.73
31-8610	150	6.3	0.79	0.77	0.73
31-8165	220	6.3	0.79	0.75	0.71
31-8615	330	8	0.79	0.77	0.73
6.3 Volts					
31-8170	22	4	0.79	0.77	0.73
31-8175	33	5	0.79	0.77	0.73
31-8180	47	5	0.79	0.77	0.73
31-8620	56	6.3	0.79	0.77	0.73
31-8185	100	6.3	0.79	0.77	0.73
31-8625	150	6.3	0.79	0.77	0.73
31-8630	220	8	0.79	0.77	0.73
31-8635	330	8	0.79	0.77	0.73
10 Volts					
31-8195	33	5	0.79	0.77	0.73
31-8640	56	6.3	0.79	0.77	0.73
31-8205	100	6.3	0.79	0.77	0.73
31-8645	150	8	0.79	0.77	0.73
31-8650	220	8	0.79	0.77	0.73
16 Volts					
31-8210	10	4	0.59	0.55	0.49
31-8215	22	5	0.79	0.77	0.73
31-8220	33	6.3	0.79	0.75	0.71
31-8225	47	6.3	0.79	0.77	0.73
31-8655	56	6.3	0.79	0.77	0.73
31-8660	100	6.3	0.79	0.77	0.73
25 Volts					
31-8230	4.7	4	0.79	0.77	0.73
31-8235	10	5	0.79	0.77	0.73
31-8240	22	6.3	0.79	0.77	0.73
31-8245	33	6.3	0.79	0.75	0.71
31-8665	47	8	0.79	0.77	0.73
31-8670	56	8	0.79	0.77	0.73
31-8675	100	8	0.79	0.77	0.73
35 Volts					
31-8680	2.2	3	0.79	0.77	0.73
31-8250	3.3	3	0.79	0.77	0.73
31-8255	4.7	4	0.79	0.77	0.73
31-8260	10	5	0.79	0.77	0.73
31-8265	22	6.3	0.79	0.77	0.73
31-8685	33	8	0.79	0.77	0.73
31-8690	47	8	0.79	0.77	0.73
50 Volts					
31-8270	.1	4	0.79	0.77	0.73
31-8275	.22	4	0.79	0.77	0.73
31-8280	.33	4	0.79	0.77	0.73
31-8285	.47	4	0.79	0.77	0.73
31-8290	1	4	0.79	0.77	0.73
31-8295	2.2	4	0.79	0.77	0.73
31-8300	3.3	4	0.79	0.77	0.73
31-8305	4.7	5	0.79	0.77	0.73
31-8310	10	6.3	0.79	0.77	0.73
31-8695	22	8	0.79	0.77	0.73
31-8700	33	8	0.79	0.77	0.73

Order #	µF	(1-4)	(5-9)	(10-24)
4 Volts				
31-8345	22	\$0.40	\$0.39	\$0.37
31-8350	33	0.40	0.39	0.37
31-8355	47	0.40	0.39	0.37
31-8360	100	0.67	0.66	0.63
31-8365	220	0.95	0.93	0.89
31-8370	330	1.15	1.12	1.07
31-8375	470	1.30	1.28	1.22
6.3 Volts				
31-8380	10	0.40	0.39	0.37
31-8385	22	0.40	0.39	0.37
31-8390	33	0.67	0.66	0.63
31-8395	47	0.67	0.66	0.63
31-8400	100	0.79	0.77	0.73
31-8405	220	1.15	1.12	1.07
31-8410	330	1.50	1.47	1.40
10 Volts				
31-8415	10	0.40	0.39	0.37
31-8420	22	0.67	0.66	0.63
31-8425	33	0.75	0.73	0.70
31-8430	47	0.87	0.85	0.81
31-8435	100	1.15	1.12	1.07
31-8440	220	1.54	1.50	1.43
16 Volts				
31-8445	4.7	0.40	0.39	0.37
31-8450	10	0.67	0.66	0.63
31-8455	22	0.99	0.97	0.92
31-8460	33	1.07	1.04	0.99
31-8465	47	1.19	1.16	1.10
31-8470	100	1.42	1.39	1.33
25 Volts				
31-8475	3.3	0.40	0.39	0.37
31-8480	4.7	0.67	0.66	0.63
31-8485	10	0.79	0.77	0.73
31-8490	22	1.15	1.12	1.07
31-8495	33	1.23	1.19	1.14
31-8500	47	1.42	1.39	1.33
31-8505	100	1.58	1.54	1.47
35 Volts				
31-8510	2.2	0.47	0.45	0.43
31-8515	3.3	0.67	0.66	0.63
31-8520	4.7	0.79	0.77	0.73
31-8525	10	0.99	0.94	0.89
31-8530	22	1.23	1.19	1.14
31-8535	33	1.30	1.28	1.22
31-8540	47	1.54	1.50	1.43
50 Volts				
31-8545	0.1	0.40	0.39	0.37
31-8550	0.22	0.40	0.39	0.37
31-8555	0.33	0.40	0.39	0.37
31-8560	0.47	0.40	0.39	0.37
31-8565	1	0.47	0.45	0.43
31-8570	2.2	0.59	0.58	0.56
31-8575	3.3	0.67	0.66	0.63
31-8580	4.7	0.83	0.81	0.77
31-8585	10	1.15	1.12	1.07
31-8590	22	1.42	1.39	1.33
31-8595	33	1.54	1.50	1.43

Electron Tubes

MCM's comprehensive inventory provides a wide selection of receiving, audio and communication tubes ready to ship immediately from stock.

Need a tube we don't presently offer...give us a call and we will do our best to locate a source. MCM delivers on all your tube needs. **Note:** Tube prices are unstable and subject to change. Due to availability, manufacturers may vary.

Order #	(1-2)	(3-9)	(10-up)
5U4GB	\$30.98	\$25.69	\$21.63
5Y3GT	10.95	9.85	8.87
6AQ5A	11.64	8.85	7.42
6AU6A	6.90	6.76	6.62
6BA6	4.99	4.59	4.19
6BL8	5.99	4.99	4.49
6BQ5	9.95	7.95	5.95
6CA7	23.56	18.55	14.67
6DJ8	15.99	15.97	15.97
6FQ7	14.49	13.76	13.07
6L6GC	13.59	10.61	8.44

Order #	(1-2)	(3-9)	(10-up)
6SN7GTB	\$18.95	\$18.02	\$17.20
6U8A	4.69	3.65	2.89
6V6GTA	13.25	11.92	10.72
6X4	8.99	7.59	6.99
12AT7	6.97	6.75	6.75
12AU7A	7.97	6.27	4.90
12AX7A	8.99	8.09	7.28
12BH7A	19.55	15.29	12.14
12BY7A	23.00	17.46	13.85
50C5	10.95	10.40	9.36
5881	18.95	18.02	17.20
6550A	31.77	27.47	24.85



Bennic Audio Grade Capacitors

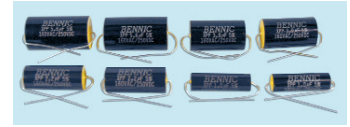

Metalized polypropylene film capacitors are ideal for crossover design, speaker upgrade or repair. They are also useful in active audio filter and coupling circuits. Utilized by speaker manufacturers worldwide, Bennic XPP Series capacitors are known for their outstanding performance/price ratio. **Features:** •Voltage rating: 250WVDC (160VAC) •Tolerance: 5% •Dissipation factor: <0.07% at 1KHz •Operating temperature range: -40°C~+85°C •Life test: 150% of rated working voltage at 105°C for 1,000 hours •**Sold individually**

Item #	Value	Dimensions (mm)		
		Diameter	Length (1-9)	(10-99) (100-up)
50-4530	0.1 µF	6	14	\$0.45 \$0.41 \$0.37
50-4533	0.15 µF	6.5	14	0.45 0.41 0.37
50-4536	0.22 µF	7	19	0.45 0.41 0.37
50-4539	0.33 µF	8	19	0.45 0.41 0.37
50-4542	0.47 µF	8.5	25	0.49 0.45 0.40
50-4545	0.68 µF	10	25	0.59 0.55 0.48
50-4548	0.82 µF	10	32	0.59 0.55 0.48
50-4551	1.0 µF	10	32	0.69 0.63 0.55
50-4554	1.5 µF	12	32	0.75 0.70 0.62
50-4557	1.8 µF	13	32	0.95 0.89 0.78
50-4560	2.2 µF	14	32	1.05 0.98 0.87
50-4563	2.7 µF	16	32	1.19 1.10 0.98
50-4566	3.3 µF	17.5	32	1.69 1.58 1.39
50-4569	3.9 µF	18	32	1.69 1.57 1.39
50-4575	5.6 µF	21	36	2.29 2.09 1.89
50-4578	6.8 µF	19	46	2.19 2.03 1.80
50-4581	7.5 µF	20.5	46	2.39 2.21 1.97
50-4584	8.2 µF	21.5	46	2.69 2.49 2.21
50-4587	10.0 µF	24	46	3.09 2.86 2.54
50-4590	12.0 µF	23	46	3.49 3.23 2.87
50-4593	15.0 µF	25	46	4.09 3.79 3.37

KEMET

Ceramic Molded Capacitors

•Operating temperature: -55°C ~125°C •Tolerance: 10% •Radial lead •Type: CK = MIL-C-11015, CKR = MIL-C-39014 •Dimensions: CK05 and CKR05 - .19" (H) x .19" (L); CK06 and CKR06 - .29" (H) x .29" (L) •Sorry-no mixing of values for quantity pricing

Order #	µF	Type	(1-4)	(5-9)	(10-24)
50 Volts					
31-4455	.022	CK05	\$0.32	\$0.28	\$0.25
31-4460	.047	CK05	0.32	0.28	0.25
31-4465	.100	CK05	0.32	0.28	0.25
31-4480	.22	CK06	0.85	0.75	0.65
31-4485	.47	CK06	1.49	1.43	1.31
31-4490	1	CK06	2.03	1.86	1.65
31-4505	.100	CKR05	1.81	1.60	1.49
100 Volts					
31-4445	.0047	CK05	0.32	0.32	0.20
31-4450	.010	CK05	0.32	0.32	0.20
31-4475	.100	CK06	0.38	0.34	0.29
31-4500	.010	CKR05	1.81	1.65	1.53
31-4515	.100	CKR06	1.70	1.65	1.43
200 Volts					
31-4440	.001	CK05	0.26	0.23	0.21
31-4470	.010	CK06	0.32	-	-
31-4495	.001	CKR05	1.49	1.39	1.27
31-4510	.010	CKR06	0.63	0.63	0.60



UNITED
CHEMI-CON

Snap-In Mount High Voltage Aluminum Electrolytic Capacitors

- Type 82DA snap mount
- Operating temperature; -40°C~85°C
- Capacitance tolerance: ± 20%

Order #	µF	(1-9)	(10-49)	(50-up)
200 Volts				
31-3385	820	\$4.39	\$3.69	\$3.19
31-3390	1000	5.29	4.29	3.39
31-3405	2200	11.95	9.95	7.95
400 Volts				
31-3480	560	8.49	7.49	6.49
450 Volts				
31-3500	470	6.49	5.49	4.99
500 Volts				
31-3515	220	7.59	6.59	5.89
31-3525	390	8.49	7.49	6.99
31-3530	470	15.19	13.99	11.99

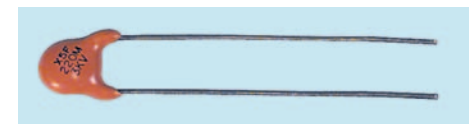

VISHAY High Voltage Ceramic Disc Capacitors

- Available in 1000, 3000 and 6000 VDC
- Operating temperature: -25°C ~ +85°C
- Tolerance ±20% • Manufacturer: Vishay Sprague

Order #	PF	(1-9)	(10-49)	(50-up)
1000VDC				
18F2677	10	\$0.39	\$0.35	\$0.31
18F2685	33	0.37	0.34	0.30
18F2687	47	0.37	0.34	0.30
18F2693	100	0.37	0.34	0.30
18F2702	330	0.37	0.34	0.30
18F2705	470	0.37	0.34	0.30
18F2706	500	0.37	0.34	0.30
66C8263	1200	0.37	0.34	0.30
18F2716	2000	0.37	0.34	0.30
18F2717	2200	0.37	0.34	0.30
66C8268	2500	0.37	0.34	0.30
18F2719	2700	0.37	0.34	0.30
18F2720	3000	0.37	0.34	0.30
18F2721	3300	0.37	0.34	0.30
18F2725	4700	0.34	0.28	0.24
87F2215	6800	0.37	0.33	0.29
87F2216	8200	0.37	0.34	0.30
3000VDC				
46F5260	10	0.39	0.35	0.31
46F5265	33	0.29	0.24	0.20
46F5267	56	0.39	0.34	0.30
46F5268	68	0.39	0.35	0.31
46F5270	150	0.39	0.35	0.31
46F5283	4700	0.56	0.49	0.42
46F5284	6800	0.63	0.57	0.49
46F5286	10000	0.86	0.81	0.68
6000VDC				
46F5236	10	0.56	0.49	0.42
46F5240	100	0.56	0.49	0.43
46F5241	220	0.56	0.49	0.43
46F5247	3300	1.29	1.02	0.85
46F5248	4700	1.79	1.47	1.26

Radial Snap-In High Temperature 105°C Low ESR Electrolytic Capacitors

- Featuring extended range of values and long life
- Ideal for power supply use • Tolerance ±20%



Order #	µF	(1-4)	(5-9)	(10-24)
50 Volts				
31-9100	2200	\$3.93	\$3.57	\$3.39
31-9105	2700	3.85	3.60	3.43
31-9110	3300	4.06	3.80	3.62
31-9115	3900	4.65	4.36	4.14
31-9120	4700	5.52	5.17	4.91
31-9125	5600	5.95	5.57	5.29
31-9130	6800	6.92	6.48	6.16
31-9135	8200	7.14	6.68	6.36
31-9140	10000	8.57	8.02	7.62
31-9145	12000	10.66	9.98	9.49
31-9150	15000	12.05	11.28	10.71
31-9155	18000	15.95	15.35	14.58
31-9160	22000	18.95	17.56	16.69
80 Volts				
31-9165	4700	9.79	9.17	8.71
31-9170	5600	10.82	10.14	9.63
31-9175	6800	12.97	12.14	11.54
31-9180	8200	18.92	17.72	16.83
31-9185	10000	20.54	19.24	18.27
100 Volts				
31-9190	1000	4.69	4.40	4.17
31-9195	1500	6.43	6.02	5.72
31-9200	2200	8.48	7.94	7.55
31-9205	3300	11.05	10.34	9.83
31-9210	4700	15.25	13.87	13.17
200 Volts				
31-9215	150	3.38	3.16	3.01
31-9220	220	3.72	3.48	3.31
31-9225	270	3.64	3.41	3.23
31-9230	330	3.91	3.66	3.47
31-9235	390	4.42	4.14	3.93
31-9240	470	4.76	4.46	4.23
31-9245	560	5.12	4.79	4.55
31-9250	680	6.09	5.70	5.42
31-9255	820	6.82	6.39	6.07
31-9260	1000	7.68	7.19	6.83
31-9265	1500	10.07	9.43	8.96
31-9270	2200	14.76	13.82	13.13
250 Volts				
31-9275	100	3.49	3.28	3.11
31-9280	120	3.66	3.43	3.25
31-9285	150	3.80	3.55	3.38
31-9290	180	3.82	3.58	3.40
31-9295	220	3.64	3.41	3.23
31-9300	270	4.13	3.87	3.68
31-9305	330	4.74	4.44	4.22

Order #	µF	(1-4)	(5-9)	(10-24)
250 Volts				
31-9310	390	\$5.26	\$4.92	\$4.68
31-9315	470	6.38	5.97	5.68
31-9320	560	7.24	6.78	6.44
31-9325	680	8.02	7.51	7.13
31-9330	820	9.00	8.43	8.00
31-9335	1000	8.12	7.60	7.22
31-9340	1200	15.46	14.47	13.75
400 Volts				
31-9345	68	3.81	3.56	3.39
31-9350	82	4.06	3.80	3.62
31-9355	100	4.36	4.08	3.87
31-9360	120	4.99	4.68	4.44
31-9365	150	5.53	5.18	4.92
31-9370	180	5.75	5.39	5.12
31-9375	220	6.56	6.14	5.83
31-9380	270	7.41	6.93	6.59
31-9385	330	8.51	7.96	7.57
31-9390	390	9.97	9.34	8.87
31-9395	470	11.05	10.34	9.83
31-9400	560	15.79	14.79	14.05
450 Volts				
31-9405	47	4.07	3.81	3.63
31-9410	68	4.18	3.91	3.72
31-9415	82	4.40	4.12	3.91
31-9420	100	5.21	4.87	4.64
31-9425	120	6.26	5.86	5.56
31-9430	150	7.28	6.82	6.48
31-9435	180	8.38	7.85	7.46
31-9440	220	10.32	9.66	9.18
31-9445	270	12.17	11.40	10.83
31-9450	330	14.35	13.43	12.76
31-9455	390	16.55	15.49	14.72
31-9460	470	19.21	17.99	17.09
500 Volts				
31-9465	47	4.18	3.91	3.72
31-9470	68	5.78	5.41	5.14
31-9475	82	6.46	6.06	5.75
31-9480	100	8.20	7.67	7.29
31-9485	120	8.86	8.29	7.88
31-9490	150	10.48	9.82	9.32
31-9495	180	11.66	10.92	10.37
31-9500	220	12.82	12.00	11.40
31-9505	270	16.06	15.04	14.29
31-9510	330	18.65	17.46	16.58
31-9515	390	19.94	18.67	17.74
31-9520	470	23.84	22.33	21.21

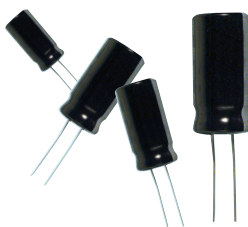

125°C Computer Grade Radial Non-Polarized/High Frequency/High-Temperature HD Capacitors

These radial aluminum electrolytics are rated for high frequency applications and are used in horizontal deflection circuits making them perfect for flyback circuitry. They are high temperature rated (up to 125°C) so they are less susceptible to heat stress.

Order #	Voltage	µF	(1-9)	(10-49)	(50-up)
310-025	25	2.2	\$2.25	\$1.85	\$1.49
310-460	25	2.7	2.34	1.94	1.61
310-045	25	3.3	2.32	1.94	1.59
310-465	25	3.9	2.47	2.04	1.70
310-065	25	4.7	2.81	2.32	1.96
310-470	25	5.6	2.69	2.21	1.84
310-085	25	6.8	3.21	2.62	2.16
310-105	25	8.5	3.60	3.02	2.42
310-125	25	10.0	3.89	3.20	2.62
310-135	25	12.0	4.05	3.24	2.78
310-145	25	15.0	4.39	3.59	3.02
310-155	25	16.0	4.74	3.72	3.15
310-475	25	18.0	4.84	4.00	3.33
310-185	25	22.0	5.11	4.23	3.53
310-480	35	2.2	2.16	1.78	1.48
310-485	35	2.7	2.41	1.99	1.65
310-490	35	3.3	2.94	2.42	2.02
310-205	35	4.7	3.03	2.48	2.03
310-495	35	5.6	3.94	3.24	2.71
310-215	35	6.8	3.60	2.89	2.42
310-500	35	8.2	4.25	3.50	2.91
310-225	35	10.0	4.50	3.71	3.02
310-235	50	1.0	2.13	1.73	1.49
310-505	50	1.5	1.69	1.39	1.16
310-255	50	2.2	1.69	1.39	1.18
310-510	50	2.7	2.25	1.85	1.54

Order #	Voltage	µF	(1-9)	(10-49)	(50-up)
310-265	50	3.3	\$2.54	\$2.16	\$1.82
310-275	50	3.9	2.93	2.42	1.96
310-285	50	4.7	2.96	2.49	2.03
310-295	50	5.6	3.21	2.62	2.16
310-305	50	6.8	3.55	2.85	2.39
310-315	50	8.2	3.83	3.12	2.66
310-335	50	10.0	4.44	3.66	3.08
310-345	50	12.0	4.74	3.94	3.24
310-355	50	15.0	4.97	4.06	3.48
310-395	50	22.0	5.42	4.41	3.71
310-415	50	33.0	5.64	4.64	3.83
310-425	50	47.0	6.09	4.99	4.17
310-515	100	1.0	2.66	2.19	1.82
310-520	100	1.5	2.75	2.27	1.88
310-525	100	2.2	2.81	2.32	1.94
310-530	100	2.7	3.28	2.71	2.26
310-435	100	3.3	3.72	3.02	2.55
310-535	100	3.9	3.94	3.24	2.71
310-455	100	4.7	4.44	3.66	3.08
310-540	100	5.6	4.84	4.00	3.33
310-545	100	6.8	4.97	4.10	3.41
310-550	100	8.2	5.16	4.25	3.54
310-555	100	10.0	5.47	4.51	3.76
310-560	100	12.0	5.88	4.84	4.04
310-565	100	15.0	6.06	5.00	4.16
310-570	100	16.0	6.22	5.13	4.27

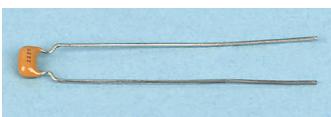

Radial Multilayer Ceramic Capacitors

•Conformally coated •Available in COG, X7R and Z5U temperature characteristics •Ultra high encapsulation consists of moisture and shock resistant coating that meets UL94V-0 •Excellent for filtering, bypass, coupling and noise suppression applications

Order #	Value pF	Type	Qty per bag (1-4 bags)	(5-9 bags)
50V				
31-4785	10000	X7R	5	\$0.96 \$0.76
31-4625	22000	X7R	1	0.20 0.09
31-4890	47000	X7R	5	1.06 0.88
31-4895	100000	X7R	5	1.06 0.88
31-4915	100000	Z5U	5	1.06 0.85
31-4900	220000	X7R	5	1.60 1.39
31-4590	330000	X7R	1	0.53 0.48
31-4905	470000	X7R	5	3.79 3.39
31-4600	680000	Z5U	1	1.06 0.99
31-4925	1000000	Z5U	5	1.60 1.39
31-4685	1500000	Z5U	1	0.63 0.57
31-4690	2200000	Z5U	1	1.81 1.75
31-4695	3300000	Z5U	1	2.34 2.13
100V				
31-4730	100	COG	5	0.96 -
31-4735	220	COG	5	0.96 0.76
31-4740	330	COG	5	0.96 0.74
31-4840	470	COG	5	1.06 0.85
31-4845	1000	COG	5	1.06 0.88
31-4850	1000	X7R	5	1.06 0.85
31-4855	2200	X7R	5	0.99 0.94
31-4860	3300	X7R	5	1.06 0.85
31-4865	4700	X7R	5	1.06 0.85
31-4870	10000	X7R	5	1.06 0.85
31-4875	22000	X7R	5	1.06 0.88
31-4880	100000	X7R	5	1.06 0.88
200V				
31-4810	10	COG	5	1.06 0.85
31-4815	22	COG	5	1.06 0.85
31-4820	33	COG	5	1.06 0.85
31-4825	47	COG	5	1.06 0.85
31-4830	100	COG	5	1.06 0.88

Ceramic Disc Capacitors

•Five per bag •Voltage 1000 *except #31-1630 is 500 •Sorry-no mixing of values for quantity pricing •Size and color may vary



Order #	Value	Price Per Bag		
		(1-4)	(5-9)	(10-24)
31-1450	2.2pF	\$0.87	\$0.75	\$0.58
31-1455	3.3pF	0.87	0.77	0.60
31-1465	4.7pF	0.87	0.75	0.58
31-1470	5.6pF	0.87	0.75	0.58
31-1485	10pF	0.87	0.75	0.58
31-1495	22pF	0.87	0.75	0.58
31-1500	33pF	0.87	0.75	0.58
31-1505	39pF	0.87	0.75	0.58
31-1510	47pF	0.87	0.77	0.60
31-1515	56pF	0.87	0.77	0.60
31-1520	68pF	0.89	0.79	0.61
31-1525	82pF	0.87	0.75	0.58
31-1530	100pF	0.87	0.77	0.60
31-1535	150pF	0.87	0.77	0.60
31-1540	220pF	0.87	0.77	0.60
31-1545	330pF	0.87	0.77	0.60
31-1550	390pF	0.87	0.77	0.60
31-1555	470pF	0.87	0.77	0.60
31-1560	560pF	0.87	0.75	0.58
31-1565	680pF	0.87	0.77	0.60
31-1570	820pF	0.87	0.77	0.60
31-1575	.001μF	0.87	0.77	0.60
31-1580	.0022μF	0.87	0.75	0.58
31-1585	.0033μF	0.87	0.77	0.60
31-1590	.0047μF	1.14	1.01	0.90
31-1595	.0056μF	1.14	1.01	0.90
31-1600	.0068μF	1.14	1.01	0.90
31-1605	.0082μF	1.14	1.01	0.90
31-1610	.01μF	1.14	1.01	0.90
31-1615	.02μF	2.08	1.96	1.78
31-1620	.033μF	2.08	1.90	1.73
31-1625	.047μF	3.06	2.84	2.51
31-1630*	.1μF	3.75	3.45	3.06

Resistors

Note: First two digits are the MCM code number and the digits following the hyphen are the resistance value. Sorry-no mixing of types/values for quantity pricing.

1/2 Watt Fusible Metal Film Flameproof Resistors

•5% tolerance •20 per bag

370-.22	370-2.2	370-4.7	370-22	370-100
370-.47	370-2.7	370-5.6	370-47	370-1K
370-1	370-3.3	370-10	370-68	

\$2.28(1-2 bags) . . . \$2.08(3-5 bags) . . . \$1.87(6 bags-up)

1/2 Watt Flameproof Resistors

•5% tolerance •Twenty per bag

66-.33	66-10	66-180	66-3.9K	66-100K
66-.47	66-15	66-220	66-5.6K	66-220K
66-.68	66-22	66-270	66-8.2K	66-240K
66-1.0	66-33	66-330	66-10K	66-270K
66-1.2	66-39	66-390	66-15K	66-1M
66-1.5	66-56	66-470	66-18K	66-2.7M
66-2.2	66-82	66-820	66-22K	
66-2.7	66-100	66-1K	66-33K	
66-3.3	66-120	66-1.5K	66-39K	
66-4.7	66-150	66-3.3K	66-47K	

\$2.18(1-2 bags) . . . \$2.04(3-5 bags) . . . \$1.81(6 bags-up)

1/2 Watt Flameproof Resistors

•5% tolerance •20 per bag

37-.22	37-5.1	37-68	37-750	37-15K
37-.33	37-5.6	37-75	37-820	37-22K
37-.47	37-6.8	37-82	37-910	37-27K
37-.51	37-8.2	37-91	37-1K	37-33K
37-.62	37-10	37-100	37-1.2K	37-39K
37-.68	37-12	37-120	37-1.5K	37-47K
37-.82	37-15	37-150	37-1.8K	37-56K
37-1	37-18	37-180	37-2K	37-68K
37-1.2	37-22	37-200	37-2.2K	37-82K
37-1.5	37-27	37-220	37-2.7K	37-91K
37-1.8	37-30	37-240	37-3K	37-100K
37-2.0	37-33	37-270	37-3.3K	37-120K
37-2.2	37-39	37-330	37-3.9K	37-150K
37-2.7	37-43	37-390	37-4.7K	37-180K
37-3.3	37-47	37-470	37-5.6K	37-200K
37-3.9	37-51	37-510	37-6.8K	37-320K
37-4.3	37-56	37-560	37-8.2K	37-1.3M
37-4.7	37-62	37-680	37-10K	37-1.5M

\$2.40(1-2 bags) . . . \$2.25(3-5 bags) . . . \$2.14(6 bags-up)

1 Watt Flameproof Resistors

•5% tolerance except for 67-1.0M which has a 10% tolerance •Ten per bag

67-.51	67-4.7	67-47	67-560	67-27K
67-.68	67-5.1	67-56	67-820	67-39K
67-1.0	67-5.6	67-68	67-1K	67-47K
67-1.2	67-10	67-100	67-2.2K	67-100K
67-1.5	67-15	67-120	67-3.9K	67-470K
67-2.0	67-22	67-150	67-8.2K	
67-2.2	67-24	67-220	67-10K	
67-2.7	67-27	67-270	67-15K	
67-3.0	67-33	67-330	67-18K	
67-3.3	67-43	67-470	67-22K	

\$1.03(1-5 bags) . . . \$0.85(6-10 bags) . . . \$0.74(11 bags-up)

1/2 Watt Carbon Film Resistors

•5% tolerance •20 per bag

65-75	65-270	65-1.5K	65-10K
65-100	65-470	65-2.2K	65-1M
65-220	65-1K	65-4.7K	

\$1.10(1-2 bags) . . . \$0.96(3-5 bags) . . . \$0.85(6 bags-up)

1 Watt Carbon Film Resistors

•5% tolerance •20 per bag

43-.47	43-2.2	43-150	43-1K	43-470K
43-1	43-2.7	43-220	43-100K	43-2.2M
43-1.2	43-3.3	43-330	43-270K	
43-2.0	43-10			

\$2.82(1-2 bags) . . . \$2.74(3-5 bags) . . . \$2.58(6 bags-up)



2 Watt Wire Wound Resistors

•10% tolerance •Five per bag

44-.10	44-.47	44-2.2	44-8.2	44-68
44-.22	44-.68	44-3.3	44-10	44-560
44-.27	44-.82	44-3.9	44-22	44-1K
44-.33	44-1.2	44-5.6	44-39	44-22K
44-.39				

\$1.87(1-3 bags) . . . \$1.67(4-9 bags) . . . \$1.13(10 bags-up)

3 Watt Wire Wound Resistors

•10% tolerance •Five per bag

45-.22	45-.47	45-2	45-10
--------	--------	------	-------

\$2.08(1-3 bags) . . . \$1.81(4-9 bags) . . . \$1.28(10 bags-up)

5 Watt Wire Wound Resistors

•10% tolerance •Five per bag

46-.10	46-.82	46-5.1	46-150	46-1K
46-.22	46-1	46-7.5	46-200	46-2K
46-.27	46-1.2	46-10	46-220	46-6.8K
46-.33	46-2.7	46-20	46-250	
46-47	46-3.3	46-33	46-300	
46-51	46-4	46-47	46-330	
46-68	46-5	46-100	46-470	

\$2.18(1-3 bags) . . . \$1.93(4-9 bags) . . . \$1.39(10 bags-up)

10 Watt Wire Wound Resistors

•10% tolerance •Five per bag

47-.33	47-4	47-7.5	47-30	47-250
47-47	47-4.7	47-8.2	47-50	47-1K
47-1	47-5	47-10	47-75	47-10K
47-2	47-6.8	47-15	47-200	
47-2.7				

\$2.50(1-3 bags) . . . \$2.14(4-9 bags) . . . \$1.71(10 bags-up)

7 Watt Wire Wound Resistors

•10% tolerance •Five per bag

62-2.7

\$2.40(1-3 bags) . . . \$2.14(4-9 bags) . . . \$1.71(10 bags-up)

7 Watt PC Standoff Resistors

•10% tolerance •Dimensions: 1 1/8" (W) x 3/8" (H) x 3/8" (D) •Lead length: 1/2" •5 per bag

116-1	116-2	116-5.6
-------	-------	---------

\$4.17(1-49 bags) . . . \$3.65(50 bags-up)

1/2 Watt Carbon Film Resistors

•5% tolerance •20 per bag

34-.68	34-39	34-330	34-3.3K	34-120K
34-1.0	34-47	34-390	34-4.7K	34-180K
34-1.2	34-51	34-470	34-5.1K	34-220K
34-2.7	34-56	34-560	34-5.6K	34-270K
34-3.3	34-68	34-620	34-8.2K	34-330K
34-4.7	34-75	34-680	34-10K	34-470K
34-5.6	34-82	34-820	34-12K	34-680K
34-10	34-100	34-1K	34-15K	34-1M
34-12	34-120	34-1.2K	34-20K	34-2.2M
34-15	34-150	34-1.5K	34-22K	34-4.7M
34-18	34-180	34-1.8K	34-33K	34-10M
34-20	34-200	34-2K	34-39K	
34-22	34-220	34-2.2K	34-47K	
34-27	34-240	34-2.7K	34-68K	
34-33	34-270	34-3K	34-100K	

\$1.20(1-2 bags) . . . \$1.03(3-5 bags) . . . \$0.93(6 bags-up)



Multicomp

multicomp 1/4 Watt Carbon Film Resistors

•5% tolerance •Minimum ten

651-1.2	651-68	651-220	651-27K	651-100K
651-2.2	651-82	651-270	651-33K	651-120K
651-3.3	651-120	651-330	651-39K	651-330K
651-5.6	651-150	651-560	651-47K	651-470K
651-33	651-180	651-820	651-56K	651-1M

\$0.07(10-99) \$0.04(100-999) \$0.02(1000-up)

multicomp 1/4 Watt Metal Film Resistors

•1% tolerance •Minimum ten

652-10	652-68	652-270	652-11K	652-100K
652-11	652-75	652-360	652-15K	652-120K
652-12	652-91	652-390	652-18K	652-150K
652-18	652-110	652-430	652-22K	652-220K
652-20	652-130	652-470	652-33K	652-470K
652-22	652-150	652-680	652-47K	652-1M
652-27	652-160	652-820	652-68K	
652-47	652-180	652-10K	652-82K	

\$0.07(10-99) \$0.04(100-999) \$0.02(1000-up)

multicomp 1/4 Watt Carbon Film Resistors

•5% tolerance •Minimum ten

341-1.2	341-22	341-270	341-22K	341-180K
341-1.8	341-27	341-390	341-68K	341-560K
341-3.3	341-33	341-560	341-82K	
341-5.6	341-68	341-12K		
341-15	341-82	341-18K		

\$0.07(10-99) \$0.04(100-999) \$0.02(1000-up)

multicomp 1/4 Watt Metal Film Resistors

•1% tolerance •Minimum ten

662-11	662-39	662-240	662-24K	662-390K
662-12	662-43	662-300	662-33K	662-470K
662-18	662-56	662-360	662-39K	662-560K
662-24	662-75	662-430	662-56K	662-680K
662-27	662-82	662-820	662-68K	
662-30	662-91	662-11K	662-120K	
662-33	662-110	662-12K	662-150K	
662-36	662-180	662-22K	662-220K	

\$0.07(10-99) \$0.04(100-999) \$0.02(1000-up)

multicomp 1/2 Watt Carbon Film Resistors

•5% tolerance •Minimum ten

371-27	371-270	371-56K	371-1.8M	371-8.2M
371-39	371-330	371-150K	371-2.2M	371-10M
371-82	371-390	371-180K	371-2.7M	
371-100	371-18K	371-390K	371-3.3M	
371-120	371-20K	371-560K	371-3.9M	
371-150	371-22K	371-820K	371-4.7M	
371-180	371-33K	371-1.2M		

\$0.07(10-99) \$0.04(100-999) \$0.02(1000-up)

multicomp 1/2 Watt Metal Film Resistors

•1% tolerance •Minimum ten

372-11	372-24	372-110	372-360	372-270K
372-12	372-27	372-130	372-430	372-390K
372-13	372-36	372-150	372-680	372-560K
372-18	372-39	372-160	372-33K	
372-20	372-75	372-180	372-68K	
372-22	372-100	372-240	372-220K	

\$0.07(10-99) \$0.04(100-999) \$0.02(1000-up)

4 Watt Ceramic Wire Wound Resistors

•SBCHE Axial fluted •10% tolerance •Five per bag

451-1	451-6.8	451-100	451-1K	451-6.8K
451-1.5	451-10	451-220	451-1.5K	451-10K
451-2.2	451-15	451-330	451-2.2K	
451-3.3	451-22	451-470	451-4.7K	
451-4.7	451-68	451-680		

\$2.29(1-3 bags) . . . \$1.99(4-9 bags) . . . \$1.79(10 bags-up)

7 Watt Ceramic Wire Wound Resistors

•SBCHE axial fluted •10% tolerance •Five per bag

621-47	621-3.9	621-10	621-1K	621-10K
621-56	621-4.7	621-12	621-1.8K	621-15K
621-82	621-5.6	621-15	621-2.2K	
621-2.2	621-6.8	621-56	621-5.6K	
621-2.7	621-8.2	621-220	621-8.2K	

\$4.49(1-3 bags) . . \$3.29(4-9 bags) . . \$2.69(10 bags-up)

11 Watt Ceramic Wire Wound Resistors

•SBCHE axial fluted •10% tolerance •Five per bag

471-4.7	471-22	471-470	471-2.2K	
471-10	471-33	471-1K	471-10K	
471-15	471-100			

\$2.99(1-3 bags) . . \$2.79(4-9 bags) . . \$2.49(10 bags-up)

Note: The digits following the hyphen are the resistance value.

2 Watt Flameproof Resistors

•Metal oxide film •Tolerance: 5% (.22~8.2Ω), 2% (10~1MΩ)
•Sold individually

440-22	440-20	440-680	440-30K
440-27	440-22	440-750	440-33K
440-33	440-27	440-910	440-39K
440-39	440-30	440-1K	440-47K
440-47	440-33	440-1.2K	440-56K
440-56	440-39	440-1.5K	440-68K
440-68	440-47	440-1.8K	440-75K
440-82	440-56	440-2K	440-82K
440-1.0	440-68	440-2.2K	440-91K
440-1.2	440-75	440-2.7K	440-100K
440-1.5	440-82	440-3K	440-120K
440-1.8	440-91	440-3.3K	440-150K
440-2.0	440-100	440-3.9K	440-180K
440-2.2	440-120	440-4.7K	440-200K
440-2.7	440-150	440-5.6K	440-220K
440-3.0	440-180	440-6.8K	440-270K
440-3.3	440-200	440-7.5K	440-330K
440-3.9	440-220	440-8.2K	440-390K
440-4.7	440-270	440-9.1K	440-470K
440-5.6	440-300	440-10K	440-560K
440-6.8	440-330	440-15K	440-680K
440-8.2	440-390	440-18K	440-750K
440-10	440-430	440-20K	440-820K
440-15	440-470	440-22K	440-910K
440-18	440-560	440-27K	440-1M

(1-9) (10-99) (100-up)
\$0.29 \$0.25 \$0.20

Audio Dummy Loads

•Non-inductive load for bench testing amplifiers

Order #	Wattage	ohm	(1-9)	(10-up)
28-0745	50	4	\$8.64	\$8.27
28-045	50	8	8.77	8.04
28-0750	100	4	12.31	11.94
28-048	100	8	12.31	11.94
28-0785	150	4	28.49	27.45
28-0790	150	8	28.07	27.04

Note: The digits following the hyphen are the resistance value.

NTE Electronics, Inc. 1/4 Watt Surface Mount Resistors

•1206 series thick film resistors •Wrap around termination with nickel barrier •Operating temperature: -55°C ~ +155°C •5% tolerance
•Minimum ten

970-0.0	970-33	970-560	970-15K
970-1.0	970-39	970-680	970-18K
970-2.2	970-47	970-820	970-20K
970-2.4	970-51	970-1K	970-24K
970-2.7	970-56	970-1.2K	970-27K
970-3.0	970-68	970-1.5K	970-33K
970-3.3	970-75	970-1.6K	970-47K
970-3.6	970-100	970-1.8K	970-56K
970-4.7	970-120	970-2K	970-62K
970-5.1	970-160	970-2.2K	970-68K
970-5.6	970-180	970-3.3K	970-82K
970-6.2	970-200	970-3.6K	970-100K
970-6.8	970-220	970-4.7K	970-220K
970-8.2	970-270	970-5.6K	970-390K
970-9.1	970-330	970-6.8K	970-470K
970-10	970-390	970-8.2K	970-1M
970-15	970-430	970-9.1K	970-10M
970-20	970-470	970-10K	
970-22	970-510	970-13K	

(10-99)	(100-999)	(1000-up)
\$0.05	\$0.04	\$0.03

NOBLE Dual Emitter Resistors

Sorry-no mixing of values for quantity pricing

Order #	Wattage	ohm	(1-49)	(50-up)
28-0500	2	.22	\$1.14	\$0.93
28-0505	2	.33	1.14	0.93
28-0510	2	.47	1.14	0.93
28-0520	3	.22	1.45	1.39
28-0525	3	.33	1.45	1.39
28-0530	3	.47	1.45	1.35
28-0540	5	.22	1.72	1.67
28-0545	5	.33	1.74	1.69
28-0550	5	.47	1.76	1.71
28-0555	5	.68	1.76	1.71

•1% metal film •RN 55D type •1/4W •25 pieces per bag

Order #	Ohm Value	Order #	Ohm Value
QW010BR	10	QW0750BR	750
QW012D2BR	12.1	QW0806BR	806
QW015BR	15	QW0825BR	825
QW020BR	20	QW0909BR	909
QW022D1BR	22.1	QW210BR	1.0K
QW024D9BR	24.9	QW1105BR	1.05K
QW027D4BR	27.4	QW211BR	1.1K
QW030D1BR	30.1	QW1121BR	1.21K
QW033D2BR	33.2	QW1124BR	1.24K
QW034D8BR	34.8	QW1127BR	1.27K
QW037D4BR	37.4	QW214BR	1.4K
QW039D2BR	39.2	QW215BR	1.5K
QW040D2BR	40.2	QW1154BR	1.54K
QW043D2BR	43.2	QW1169BR	1.69K
QW045D3BR	45.3	QW1182BR	1.82K
QW047D5BR	47.5	QW220BR	2.0K
QW049D9BR	49.9	QW1215BR	2.15K
QW051D1BR	51.1	QW1221BR	2.21K
QW056D2BR	56.2	QW1232BR	2.32K
QW061D9BR	61.9	QW1237BR	2.37K
QW075BR	75	QW1249BR	2.49K
QW080D6BR	80.6	QW1261BR	2.61K
QW090D9BR	90.9	QW1274BR	2.74K
QW110BR	100	QW1287BR	2.87K
QW0121BR	121	QW1294BR	2.94K
QW0133BR	133	QW1301BR	3.01K
QW115BR	150	QW1309BR	3.09K
QW0182BR	182	QW1316BR	3.16K
QW120BR	200	QW1324BR	3.24K
QW0215BR	215	QW1332BR	3.32K
QW0221BR	221	QW1348BR	3.48K
QW0232BR	232	QW1365BR	3.65K
QW0243BR	243	QW1392BR	3.92K
QW0249BR	249	QW1402BR	4.02K
QW0274BR	274	QW1432BR	4.32K
QW0301BR	301	QW1464BR	4.64K
QW0316BR	316	QW1475BR	4.75K
QW0332BR	332	QW1499BR	4.99K
QW0348BR	348	QW1511BR	5.11K
QW0392BR	392	QW1523BR	5.23K
QW0402BR	402	QW1536BR	5.36K
QW0422BR	422	QW1562BR	5.62K
QW0432BR	432	QW1604BR	6.04K
QW0475BR	475	QW1619BR	6.19K
QW0499BR	499	QW262BR	6.2K
QW0511BR	511	QW1634BR	6.34K
QW0523BR	523	QW1681BR	6.81K
QW0562BR	562	QW1698BR	6.98K
QW0681BR	681	QW275BR	7.5K
QW0732BR	732	QW1768BR	7.68K

\$1.98 (1-3 bags) \$1.95 (4-9 bags) \$1.84 (10 bags-up)

NTE 25 Watt
ELECTRONICS, INC. Power
Wirewound Resistors

•5% tolerance



Order #	ohm	Order #	ohm	Order #	ohm
25WD20	0.2	25W6D8	6.8	25W133	330
25WD22	0.22	25W8D2	8.2	25W139	390
25WD27	0.27	25W010	10	25W147	470
25WD30	0.3	25W015	15	25W156	560
25WD33	0.33	25W020	20	25W168	680
25WD47	0.47	25W027	27	25W210	1K
25WD51	0.51	25W030	30	25W212	1.2K
25W1D0	1	25W039	39	25W215	1.5K
25W1D2	1.2	25W047	47	25W218	1.8K
25W1D5	1.5	25W062	62	25W222	2.2K
25W2D0	2	25W075	75	25W227	2.7K
25W2D2	2.2	25W110	100	25W233	3.3K
25W2D7	2.7	25W112	120	25W247	4.7K
25W3D3	3.3	25W115	150	25W256	5.6K
25W3D9	3.9	25W118	180	25W268	6.8K
25W4D7	4.7	25W122	220	25W282	8.2K
25W5D1	5.1	25W127	270		

\$0.87 (1-3).....\$0.79 (4-9)\$0.69 (10-up)



Need an additional catalog?
Request one @
www.mcmelectronics.com



Surface Mount Resistors

•20 pieces per bag

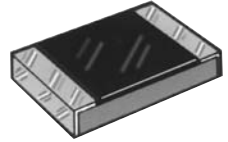

Order #	Description
SR1-0603-210	RES-0603, 1Kohm 5%
SR1-0603-310	RES-0603, 10Kohm 5%
SR1-0603-610	RES-0603, 10Mohm 5%
SR1-0805-015	RES-0805, 15ohm 5%
SR1-0805-047	RES-0805, 47ohm 5%
SR1-0805-110	RES-0805, 100ohm 5%
SR1-0805-112	RES-0805, 120ohm 5%
SR1-0805-210	RES-0805, 1Kohm 5%
SR1-0805-220	RES-0805, 2Kohm 5%
SR1-0805-247	RES-0805, 4.7Kohm 5%
SR1-0805-410	RES-0805, 100Kohm 5%
SR1-1206-010	RES-1206, 10ohm 5%
SR1-1206-022	RES-1206, 22ohm 5%
SR1-1206-033	RES-1206, 33ohm 5%
SR1-1206-047	RES-1206, 47ohm 5%
SR1-1206-110	RES-1206, 100ohm 5%
SR1-1206-115	RES-1206, 150ohm 5%
SR1-1206-118	RES-1206, 180ohm 5%
SR1-1206-122	RES-1206, 220ohm 5%
SR1-1206-133	RES-1206, 330ohm 5%
SR1-1206-139	RES-1206, 390ohm 5%
SR1-1206-147	RES-1206, 470ohm 5%
SR1-1206-1D0	RES-1206, 1.0ohm 5%
SR1-1206-210	RES-1206, 1Kohm 5%
SR1-1206-215	RES-1206, 150ohm 5%
SR1-1206-222	RES-1206, 2.2Kohm 5%
SR1-1206-233	RES-1206, 3.3Kohm 5%
SR1-1206-247	RES-1206, 4.7Kohm 5%
SR1-1206-310	RES-1206, 10Kohm 5%
SR1-1206-347	RES-1206, 47Kohm 5%
SR1-1206-410	RES-1206, 100Kohm 5%
SR1-1206-447	RES-1206, 470Kohm 5%

\$0.99 (1-3 bags) ..\$0.93 (4-9 bags) ..\$0.88 (10 bags-up)



THERMODISC Thermal Fuses

•Used in heat guns, hair dryers and other small household appliance •Maximum current rating: 15A •Sorry-no mixing of values for quantity pricing

Order #	ERS®/ECG/ NTE® Type	Maximum Operating Temperature °C	°F
17-100	8070	72	158
17-105	8076	77	171
17-110	8081	84	178
17-115	8085, 8090	91	196
17-120	8086	98	204
17-125	8103	104	218
17-130	8103	109	229
17-135	8115	117	239
17-140	8118	121	244
17-145	8125	128	257
17-150	8149	152	306
17-155	8167	167	333
17-160	8181	184	363
17-165	8182	192	377
17-170	8213	216	421
17-175	8226	228	443
17-180	8242	240	464

\$1.26 (1-4) \$1.14 (5-9).....\$1.00 (10-29)

Variable Load Resistors

• Designed for testing high current power supplies, amplifiers, etc. • Wiper ring is moved across resistor body to vary resistance

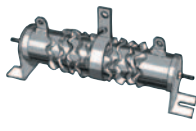

Order #	ohm	Maximum Wattage	(ea.)
28-1225	0-8	90	\$16.46
28-1230	0-18	225	41.77



Microwave Oven Diode

• Popular in Amana, Litton, Tappan and many more
• Replaces HVR-1X-4 and other high-voltage diodes using 3/4" female guide connect on anode and ring terminal on cathode

Order #	(1-9)	(10-up)
75-100	\$3.18	\$2.75

Carbon Film Resistor Kit 1/4W

High-quality carbon film resistors with a connecting wire that is easily soldered. Applications: TVs, audio and video equipment, telephone receivers and communication systems, instrumentation, home appliances and more. **Specifications:** • Quantity: 610 pieces (10 pieces per value) • Series: E12 • Number of values: 61 (from 10E to 1M) • Operating temperature range: -67°F~311°F • Tolerance: 5% • Max operating voltage: 250V



Order #	(1-3 kits)	(4-kits-up)
80-6665	\$8.79	\$7.22

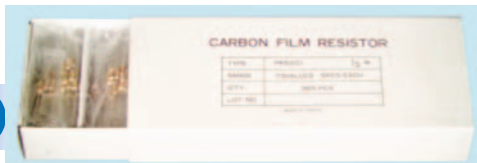

ELENCO Carbon Film Resistor Kit 1/2W

• Contains five each of 73 standard values from 1Ω~1MΩ • 365 total pieces

Order #	(1-9 kits)	(10-24 kits)
80-6670	\$13.25	\$12.31

Trim Pot Kit

• Save 38% off list price when you purchase this kit
• Kit offers 31-1/2W trim pots available in vertical and horizontal mount **Kit contains five each of:**



100	100K	5K	1K
50K	200	250K	30K
50K	3K	500	1Mohm
100	100K	25K	1K
2.5K	300	500K	25K
50K	20K	500	1Mohm
200	250K	10K	3K
10K	300	500K	

Order #	(kit)
102-009	\$24.95



NTE Resistor Kits

• Each kit contains 30 of the most popular values • Plastic cabinet with 15, two section drawers • Cabinets stack together to build a component storage center • Easily wall mounted or stacked

1/2 Watt Metal Film

Contains six each of the following (in ohms):

10	150	680	2.2K	15K	47K
22	220	1K	3.3K	20K	100K
47	330	1.5K	4.7K	22K	220K
100	390	1.8K	6.8K	27K	330K
120	470	2K	10K	33K	1M

Order #	(1-5 kits)	(6-9 kits)	(10 kits-up)
RK-01	\$35.95	\$34.95	\$32.95

1/2 Watt Metal Film

Contains four each of the following (in ohms):

1.0	56	220	680	2.2K	10K
10	75	330	1K	2.7K	22K
15	100	390	1.2K	3.3K	33K
22	120	470	1.5K	4.7K	47K
47	150	560	2K	8.2K	100K

Order #	(1-5 kits)	(6-9 kits)	(10 kits-up)
RK-02	\$29.95	\$28.95	\$26.95

1/2 Watt Metal Film

Contains six each of the following (in ohms):

1.0	33	220	1K	3.9K	47K
1.5	47	330	1.5K	4.7K	100K
2.2	100	470	1.8K	10K	220K
10	120	560	2.2K	15K	470K
22	150	680	3.3K	22K	1M

Order #	(1-5 kits)	(6-9 kits)	(10 kits-up)
RK-03	\$44.95	\$42.95	\$39.95

1 Watt Metal Oxide

Contains four each of the following (in ohms):

.22	2.2	33	150	1K	10K
.47	4.7	47	220	1.5K	47K
1.0	10	68	330	2K	100K
1.5	22	100	470	2.2K	220K
2.0	24	120	510	4.7K	1M

Order #	(1-5 kits)	(6-9 kits)	(10 kits-up)
RK-04	\$44.95	\$42.95	\$39.95

Linear Slide Potentiometers

ALPS standard slide potentiometers. Low profile PCB mounting slide potentiometers. Ideal for volume, tone or balance controls in audio equipment and graphic equalizers. **Specifications:** Resistance tolerance ±20%, rated voltage 150, rated power: 45mm is 0.125W, and 60mm is 0.1W.



Order #	Description	(ea.)
RE00423	50K 45mm travel	\$2.60

Pocket Reference (2nd Edition)

Loaded with constants and formulas pertaining to: Math, plumbing, automobiles, carpentry, glues, solvents, chemistry, physics, computers, electronics, and much more. 480 pages, soft cover.

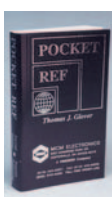

Order #	(ea.)
81-1695	\$9.95

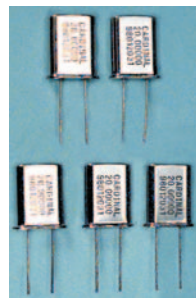

Crystals

• Full-size • Resistance weld
• ±50ppm from -10°~70°C
• Package style: HC49/U

Order #	ESR (Ohms)		Circuit Frequency Calibration		
	Max	(MHz)	Condition (1-9)	(10-49)	(50-up)
31-4000	100	4.000	Series	\$1.35	\$1.14 \$1.04
31-4010	100	4.194304	12pf	1.35	1.14 1.04
31-4025	100	5.000	30pf	1.35	1.14 1.04
31-4035	50	6.000	20pf	1.35	1.14 1.04
31-4050	45	8.000	18pf	1.35	1.14 1.04
31-4080	30	10.000	20pf	1.35	1.14 1.04
31-4095	30	12.000	Series	1.35	1.14 1.04
31-4110	25	14.31818	Series	1.35	1.14 1.04
31-4140	25	20.000	20pf	1.46	1.25 1.14

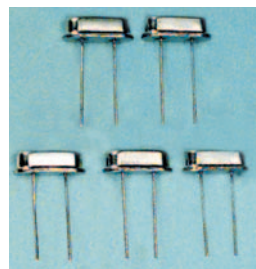

Low Profile Crystals

• Resistance weld
• ±50ppm from -10°~70°C • Package style: HC49/S

Order #	ESR (Ohms)		Circuit Frequency Calibration		
	Max	(MHz)	Condition (1-9)	(10-49)	(50-up)
31-4155	150	4.000000	20pf	\$1.77	\$1.46 \$1.35
31-4185	35	11.509200	16pf	1.67	1.50 1.39



ELENCO Diode/Transistor Tester Kit

Build your own diode/transistor tester. This dynamic tester allows checking of transistors and diodes in circuit. You can identify NPN or PNP transistors. Also checks all types, small or large power and identifies anode or cathode of diodes.

Order #	(kit)
80-1170	\$27.50

McGraw-Hill Electronics Demystified

• Now anyone with an interest in electronics can master it
• In Electronics Demystified, best-selling science and math writer Stan Gibilisco provides an effective and painless way to understand the electronics that power so much of modern life • With Electronics Demystified, you master the

subject one simple step at a time; at your own speed
• Unique self-teaching guide offers problems at the end of each chapter and section to pinpoint weaknesses, and a 70-question final exam to reinforce the entire book • Master electronics essentials that can help you as an employee, a hobbyist, or merely as a consumer • A fast, effective, and fun way to learn electronics, Electronics Demystified is the perfect shortcut to a deeper understanding of many of today's most important technologies

Order #	(ea.)
81-3251	\$19.95

Sorry-Books are not returnable.

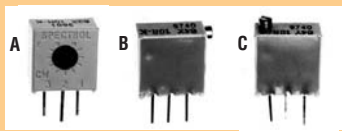

Spectrol Trimmer - 3/8" Square Multi Turn Cermet

- Multifinger precious metal wiper for long term set point stability
- Central pivot locating gear for improved stability
- Unique ratchet device integral with gear to ensure long term reliability
- Double chevron shaft for sealing plus consistent torque and reliable adjustability
- IC style pins for easier board insertion
- 64W and 64Y are top adjust, 64X are side adjust

Fig.	Order #	Spectrol #	Ohm	(1-4)	(5-9)
A	500-0194	64W500	50	\$2.05	\$1.89
A	500-0195	64W-101	100	2.05	1.89
A	500-0197	64W501	500	2.05	1.89
A	500-0198	64W-102	1K	2.05	1.89
A	500-0199	64W-202	2K	2.05	1.89
A	500-0200	64W-502	5K	2.05	1.89
A	500-0201	64W-103	10K	2.05	1.89
A	500-0202	64W-203	20K	2.05	1.89
A	500-0203	64W-253	25K	2.05	1.89
A	500-0204	64W503	50K	2.05	1.89
A	500-0205	64W-104	100K	2.05	1.89
B	500-0217	64X501	50	2.05	1.89
B	500-0218	64X-101	100	2.05	1.89
B	500-0221	64X-102	1K	2.05	1.89
B	500-0222	64X-202	2K	2.05	1.89
B	500-0223	64X-502	5K	2.05	1.89
B	500-0224	64X-103	10K	2.05	1.89
B	500-0226	64X-253	25K	2.05	1.89
B	500-0228	64X-104	100K	2.05	1.89
C	500-0243	64Y-101	100	2.05	1.89
C	500-0246	64Y-102	1K	2.05	1.89
C	500-0248	64Y-502	5K	2.05	1.89
C	500-0249	64Y-103	10K	2.05	1.89
C	500-0252	64Y503	50K	2.05	1.89
C	500-0253	64Y-104	100K	2.05	1.89

NTE Spectrol Trimmer - 3/8" Rectangular Multiturn Cermet

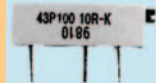

- Multifinger wiper for better contact resistance variation
- Unique "T" slider block for excellent stability and setability
- Chevron shaft for sealing and smooth consistent torque
- IC style pins for easier board insertion

Order #	Spectrol #	Ohm	(1-4)	(5-9)
500-0004	43P-101	100	\$1.39	\$1.29
500-0007	43P-102	1K	1.39	1.29
500-0008	43P-202	2K	1.39	1.29
500-0009	43P-502	5K	1.39	1.29
500-0010	43P-103	10K	1.39	1.29
500-0011	43P-203	20K	1.39	1.29
500-0013	43P-503	50K	1.39	1.29
500-0014	43P-104	100K	1.39	1.29

NTE Spectrol Trimmer - 3/8" Square Single Turn Cermet

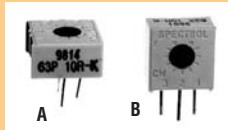

- Multifinger wiper for better contact resistance
- Arrow and graduations for repeatable settings
- "O" ring seal for solvent and aqueous washing
- IC style pins for easier board insertion
- Solid end stop
- 63P are top adjust, 63X are side adjust

Fig.	Order #	Spectrol #	Ohm	(1-4)	(5-9)
A	500-0073	63P-101	100	\$1.05	\$0.99
A	500-0076	63P-102	1K	1.05	0.99
A	500-0078	63P-502	5K	1.05	0.99
A	500-0079	63P-103	10K	1.05	0.99
A	500-0083	63P-104	100K	1.05	0.99
A	500-0086	63P-504	500K	1.05	0.99
B	500-0368	63X-101	100	1.05	0.99
B	500-0371	63X-102	1K	1.05	0.99
B	500-0372	63X-202	2K	1.05	0.99
B	500-0373	63X-502	5K	1.05	0.99
B	500-0374	63X-103	10K	1.05	0.99
B	500-0375	63X-203	20K	1.05	0.99
B	500-0378	63X-104	100K	1.05	0.99

NTE Spectrol Trimmer - 3/8" Square Single Turn Cermet



- Top adjust
- Multifinger wiper for better contact resistance
- Withstands immersion cleaning process
- Graduations for easier setting
- Rotor design for automatic adjustment

Order #	Value Spectrol #	Ohm	(1-4)	(5-9)
500-0343	76P-101	100	\$1.75	\$1.49
500-0346	76P-102	1K	1.75	1.49
500-0348	76P-502	5K	1.75	1.49
500-0349	76P-103	10K	1.75	1.49
500-0352	76P-104	100K	1.75	1.49

NTE 2 Watt Potentiometers

- Linear taper
- 3/8" diameter shaft
- Hot molded carbon element
- Gold plated terminals
- Stainless steel shaft and housing
- Meets or exceeds specifications of MIL-R-QPL listed
- Operating temperature: -65°C~+125°C
- Sorry--no mixing of values for quantity pricing

Order #	PEC #	Value (ohm)	Shaft Length
501-0002	KU1011S28	100	3/8"
501-0003	KU2511S28	250	3/8"
501-0004	KU5011S28	500	3/8"
501-0005	KU1021S28	1K	3/8"
501-0006	KU2021S28	2K	3/8"
501-0007	KU2521S28	2.5K	3/8"
501-0009	KU5021S28	5K	3/8"
501-0010	KU1031S28	10K	3/8"
501-0012	KU2531S28	25K	3/8"
501-0014	KU5031S28	50K	3/8"
501-0015	KU1041S28	100K	3/8"
501-0017	KU2541S28	250K	3/8"
501-0018	KU5041S28	500K	3/8"
501-0019	KU1051S28	1M	3/8"
501-0034	KU1021S64	1K	2"
501-0038	KU5021S64	5K	2"
501-0039	KU1031S64	10K	2"

(1-9)	(10-24)	(25-49)	(50-99)	(100-up)
\$9.29	\$8.39	\$7.95	\$7.59	\$7.29



3 Watt Precision Wirewound Potentiometer

- 10 turn
- 3/8" round case
- Shaft dimensions: 3/8" (L) x 3/8" (dia.)
- Stainless steel shaft
- Permanickel contact
- Gold plated terminals
- Precision winding with excellent linearity
- Operating temperature: -55°C~+125°C
- Sorry--no mixing of values for quantity pricing

Order #	Spectrol #	Value (ohm)	(1-9)	(10-24)	(25-49)
502-0102	534-1-1-501	500	\$12.49	\$12.19	\$11.89
502-0103	534-1-1-102	1K	12.49	12.19	11.89
502-0104	534-1-1-202	2K	12.49	12.19	11.89
502-0105	534-1-1-502	5K	12.49	12.19	11.89
502-0106	534-1-1-103	10K	12.49	12.19	11.89
502-0107	534-1-1-203	20K	12.49	12.19	11.89
502-0108	534-1-1-503	50K	14.95	14.49	13.95
502-0109	534-1-1-104	100K	16.39	15.49	14.79

Call for Larger Quantity Pricing



1/4 Watt Audio Taper Potentiometers

- Shaft dimensions: 1" (L) x 3/8" (dia)

Order #	ohm	Order #	ohm
28-10810	1K	28-10835	100K
28-10815	5K	28-10840	250K
28-10820	10K	28-10845	500K
28-10825	20K	28-10850	1M
28-10830	50K		

\$1.15 (ea.)



Potentiometers with SPST Switch

- Visit www.mcmelectronics.com for detailed specifications.

Order #	Description	(ea.)
28-10855	1/2W, 5Kohm, audio taper	\$1.99
28-10860	1/2W, 10Kohm, audio taper	1.99
28-10865	1/2W, 5Kohm, linear taper	1.99
28-10870	1/2W, 10Kohm, linear taper	1.99

1/2 Watt Potentiometers

- Linear taper
- Shaft dimensions: 1" (L) x 3/8" (dia)

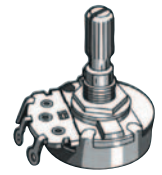

Order #	ohm	Order #	ohm	Order #	ohm
28-0675	1K	28-0683	20K	28-0690	250K
28-0678	5K	28-0685	50K	28-0693	500K
28-0680	10K	28-0688	100K	28-0695	1M

\$1.14 (ea.)

1/2 Watt Vertical Potentiometers

- Sorry--no mixing of values for quantity pricing

Order #	ohm	Order #	ohm
28-420	100	28-445	5K
28-425	200	28-450	10K
28-435	500	28-463	100K
28-438	1K		

\$0.37(1-9) \$0.33(10-99) \$0.28(100-up)

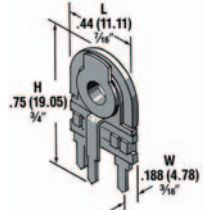

1/2 Watt Horizontal Potentiometers

- Sorry--no mixing of values for quantity pricing

Order #	ohm	Order #	ohm
28-490	5K	28-503	250K
28-493	10K	28-505	500K
28-500	100K		

\$0.37(1-9) \$0.33(10-99) \$0.28(100-up)

