

## LOW POWER, BANDGAP VOLTAGE REFERENCES

### FEATURES

- Temperature Coefficient ..... 50ppm/°C
- Wide Operating Current Range
  - TC04 ..... 15µA to 20mA
  - TC05 ..... 20µA to 20mA
- Dynamic Impedance ..... 1Ω
- Output Tolerance ..... Typ. 2%
- Output Voltage Option
  - TC04 ..... 1.25V
  - TC05 ..... 2.5V
- TO-92 Plastic Package
- 8-Pin Plastic Narrow Body SOIC Package

### APPLICATIONS

- ADC and DAC Reference
- Current Source Generation
- Threshold Detectors
- Power Supplies
- Multimeters

### GENERAL DESCRIPTION

The TC04 (1.25V output) and TC05 (2.5V output) bipolar, two-terminal, bandgap voltage references offer precision performance without premium price. These devices do not require thin-film resistors, greatly lowering manufacturing complexity and cost.

A 50ppm/°C output temperature coefficient and 15µA to 20mA operating current range make these devices attractive for multimeter, data acquisition converter, and telecommunication voltage references.

3

### PIN CONFIGURATIONS

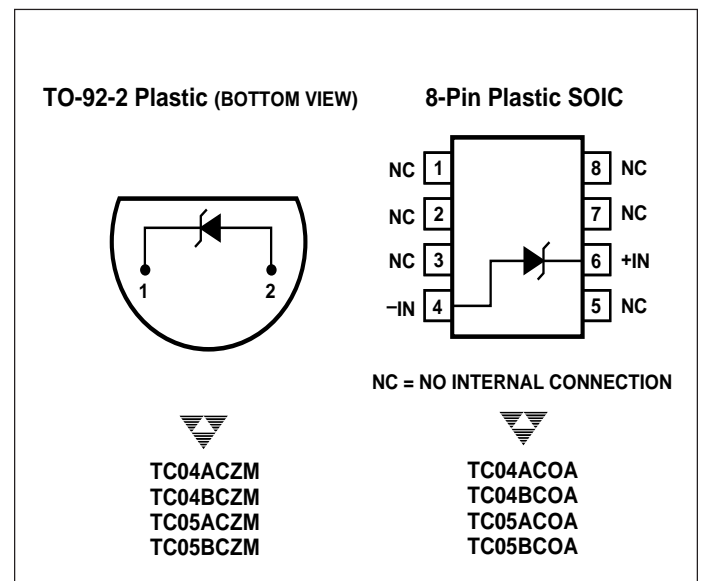

### ORDERING INFORMATION

Part No.	Package	Temperature Range	Voltage	Max. Temperature Coefficient
TC04ACOA	8-Pin SOIC	0°C to +70°C	1.25V	50ppm/°C
TC04ACZM	TO-92-2	0°C to +70°C	1.25V	50ppm/°C
TC04BCOA	8-Pin SOIC	0°C to +70°C	1.25V	100ppm/°C
TC04BCZM	TO-92-2	0°C to +70°C	1.25V	100ppm/°C
TC05ACOA	8-Pin SOIC	0°C to +70°C	2.5V	50ppm/°C
TC05ACZM	TO-92-2	0°C to +70°C	2.5V	50ppm/°C
TC05BCOA	8-Pin SOIC	0°C to +70°C	2.5V	100ppm/°C
TC05BCZM	TO-92-2	0°C to +70°C	2.5V	100ppm/°C

TC04A  
TC04B  
TC05A  
TC05B

LOW POWER, BANDGAP  
VOLTAGE REFERENCES

**ABSOLUTE MAXIMUM RATINGS\***

Forward Current .....	+10mA
Reverse Current .....	+30mA
Storage Temperature Range .....	- 65°C to +150°C
Operating Temperature Range	
TO-92 Package .....	0°C to +70°C
Surface Mount Package .....	0°C to +70°C

Lead Temperature (Soldering, 10 sec)	
TO-92 Package .....	+300°C
Surface Mount Package .....	+300°C
Power Dissipation .....	Limited by Forward/ Reverse Current

\*Functional operation above the absolute maximum stress ratings is not implied.

**ELECTRICAL CHARACTERISTICS:**  $T_A = +25^\circ\text{C}$ , unless otherwise specified.

Symbol	Parameter	Test Conditions	Min	Typ	Max	Unit
$V_{BR}$	Reverse Breakdown Voltage: TC04 TC05	$I_R = 100\mu\text{A}$	1.24 2.45	1.26 2.50	1.28 2.60	V
$DV_{BR}$	Reverse Breakdown Voltage Change: TC04  TC05	$15\mu\text{A} < I_R < 20\text{mA}$ $20\mu\text{A} < I_R < 1\text{mA}$ $20\mu\text{A} < I_R < 20\text{mA}$ $25\mu\text{A} < I_R < 1\text{mA}$	— — — —	10 0.25 10 0.25	20 1 20 1	mV
TC	Temperature Coefficient: TC04A/TC05A TC04B/TC05B	$I_R = 100\mu\text{A}$	— —	0.003 0.003	0.005 0.01	%/°C
$I_R$	Reverse Current: TC04 TC05		0.015 0.020	— —	20 20	mA

RESPONSE TIME TEST CIRCUIT

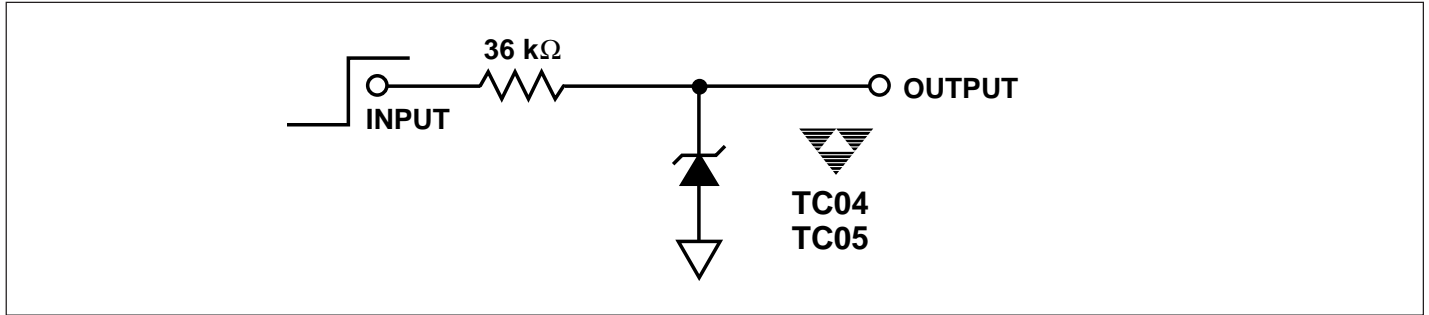

3

TYPICAL APPLICATIONS

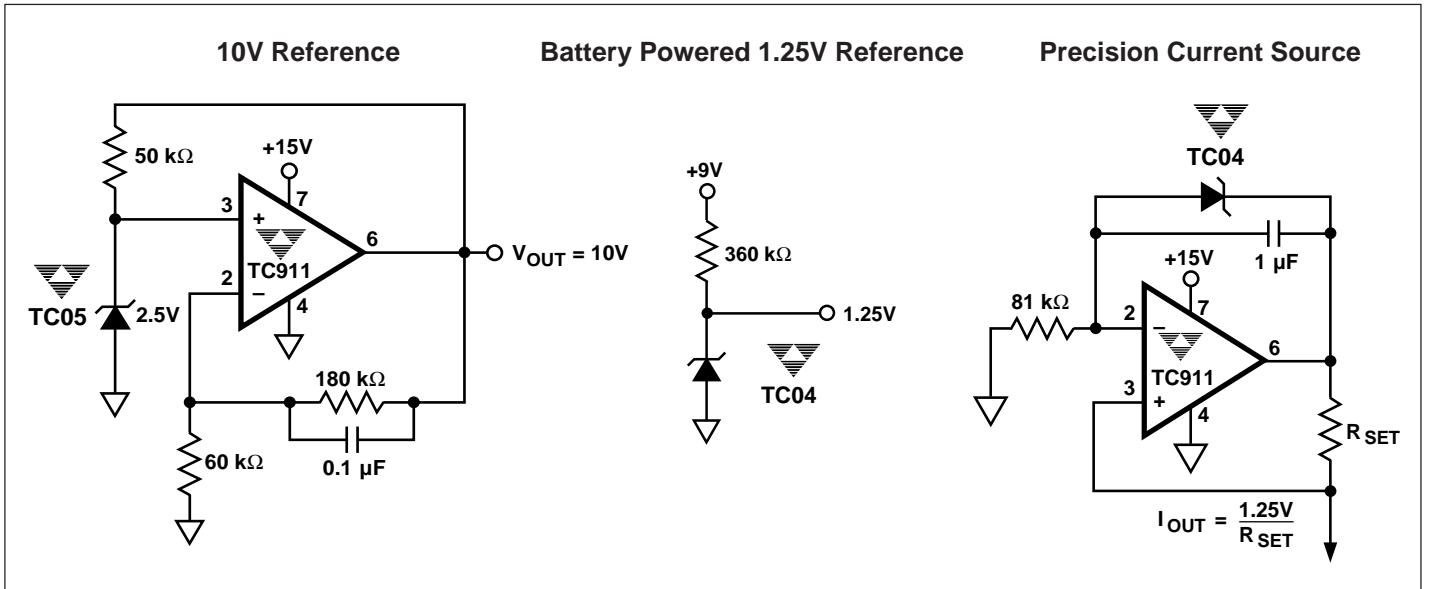

TYPICAL CHARACTERISTICS

TC04: Output Voltage vs Reverse Current

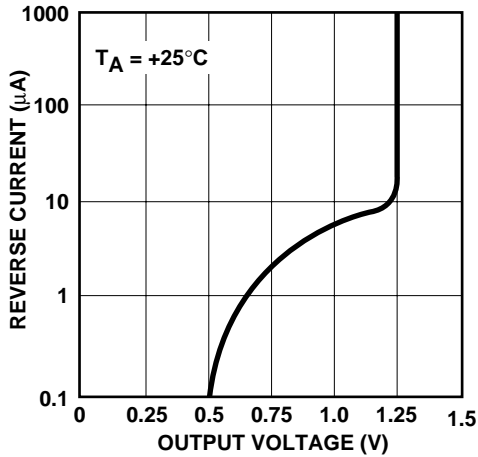

TC04: Output Voltage Change vs Reverse Current

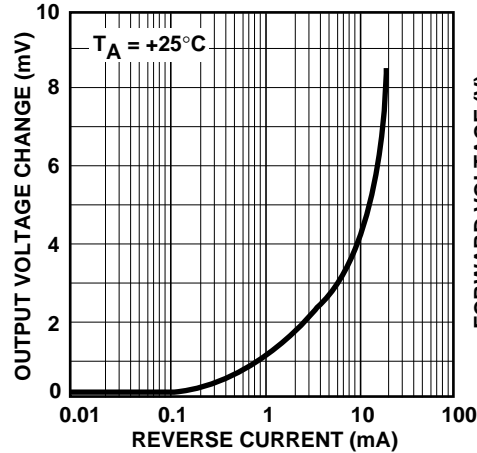

TC04: Forward Voltage vs Forward Current

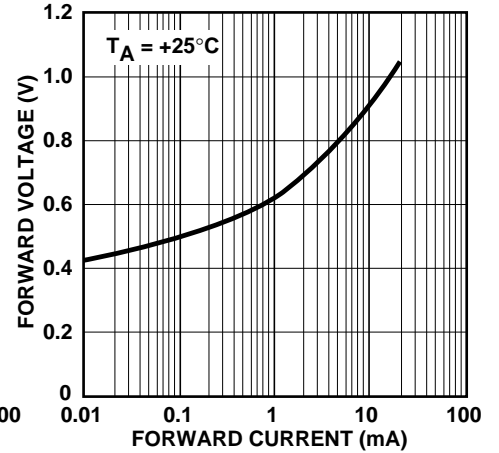

TC04 Response Time

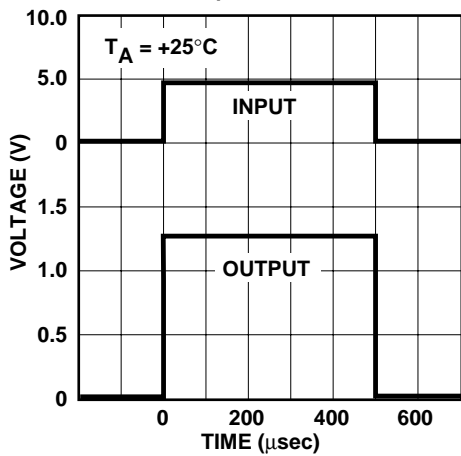

TC05: Output Voltage vs Reverse Current

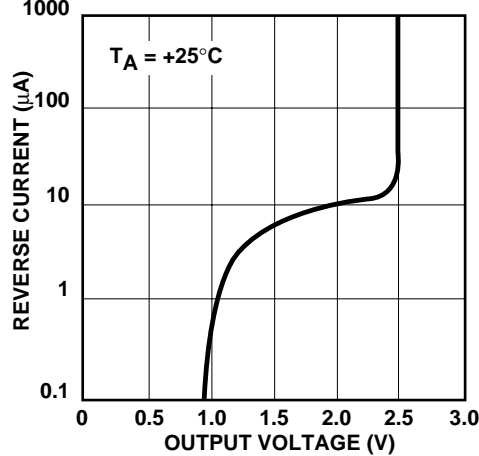

TC05: Output Voltage Change vs Reverse Current

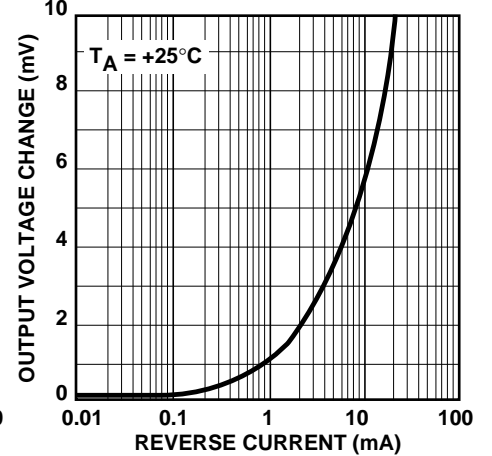

TC05: Forward Voltage vs Forward Current

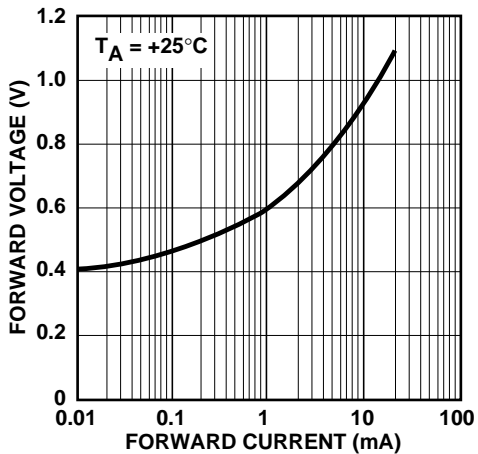

TC05 Response Time

