

Small Signal Diode

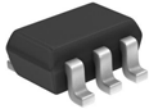

Features

- ✧ Meet IEC61000-4-2 (ESD) $\pm 15\text{kV}$ (air), $\pm 8\text{kV}$ (contact)
- ✧ Meet IEC61000-4-4 (EFT) rating. 40A (5/50ns)
- ✧ Meet IEC61000-4-5 (Lightning) rating. 24A (8/20 μs)
- ✧ Protects four high speed I/O lines
- ✧ Working Voltage : 5V
- ✧ Pb free version, RoHS compliant, and Halogen free

Mechanical Data

- ✧ Case : SOT-26 standard package, molded plastic
- ✧ Terminal: Matte tin plated, lead free, solderable per MIL-STD-202, Method 202 guaranteed
- ✧ High temperature soldering guaranteed: 260°C/10s
- ✧ Molding Compound Flammability Rating : UL 94V-O
- ✧ Weight : 16 mg (approximately)
- ✧ Marking Code : Y B05

Applications

- ✧ USB Power & Data Line Protection
- ✧ Notebooks, Desktops, Servers and Video Graphics Cards
- ✧ Monitors and Flat Panel Displays
- ✧ Portable Instrumentation
- ✧ Set Top Box

Ordering Information

Part No.	Package	Packing	Packing Code	Marking
TESDS5V0ALC	SOT-26	3K / 7" Reel	RFG	Y B05

Maximum Ratings and Electrical Characteristics

Rating at 25°C ambient temperature unless otherwise specified.

Maximum Ratings

Type Number	Symbol	Value	Units
Peak Pulse Power (tp=8/20 μs waveform)	P _{PP}	200	W
Peak Pulse Current (tp = 8/20 μs)	I _{PP}	5	A
ESD per IEC 61000-4-2 (Air)	V _{ESD}	± 27	KV
ESD per IEC 61000-4-2 (Contact)		± 16	
Junction and Storage Temperature Range	T _J , T _{STG}	-55 to + 150	°C

Electrical Characteristics

Type Number	Symbol	Min	Max	Units
Reverse Stand-Off Voltage	V _{RWM}	-	5	V
Reverse Breakdown Voltage	V _(BR)	6.5	-	V
Reverse Leakage Current	I _R	-	0.1	μA
Clamping Voltage	V _C	I _{PP} = 1A	9.8	V
		I _{PP} = 3A	17	
Junction Capacitance	C _J	0.7 (Typ.)		pF

SOT-26

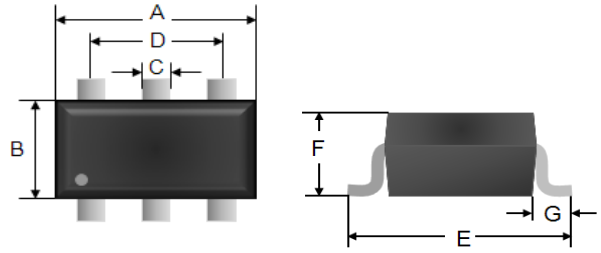

Dimensions	Unit (mm)		Unit (inch)	
	Min	Max	Min	Max
A	2.80	3.00	0.110	0.118
B	1.50	1.70	0.059	0.067
C	0.30	0.50	0.012	0.020
D	1.80	2.00	0.071	0.079
E	2.65	2.95	0.104	0.112
F	1.05	1.15	0.041	0.045
G	0.575 REF		0.022 REF	

Pin Configuration

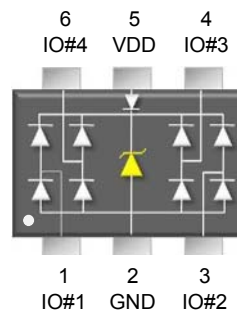

Small Signal Diode

Rating and Characteristic Curves

FIG 1 Non-Repetitive Peak Pulse Power vs. Pulse Time

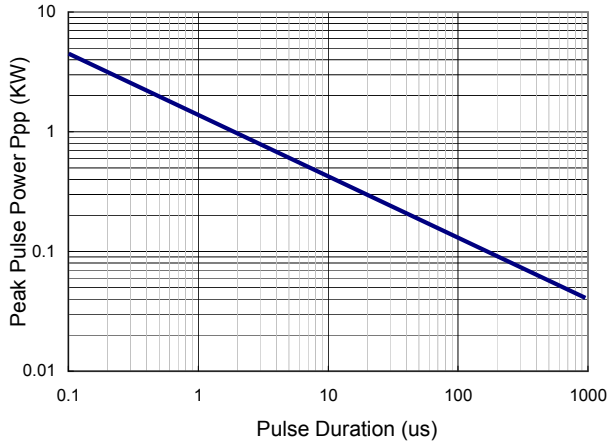

FIG 2 Pulse Waveform

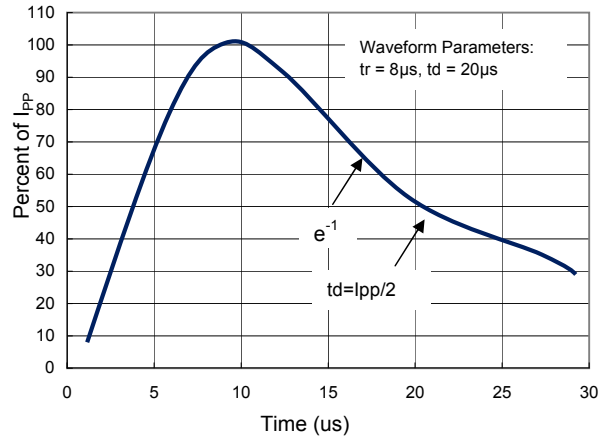

FIG 3 Admissible Power Dissipation Curve

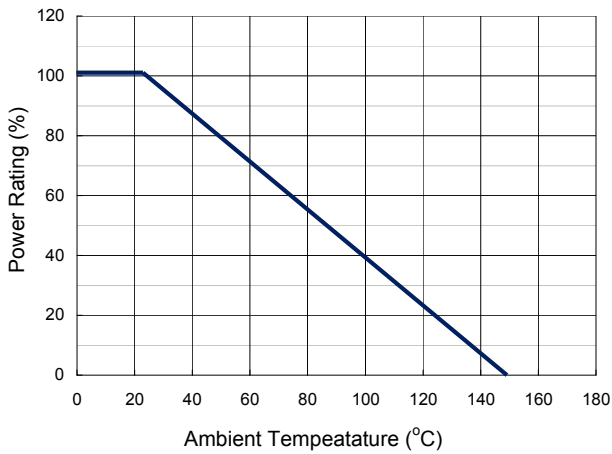

FIG 4 Typical Junction Capacitance

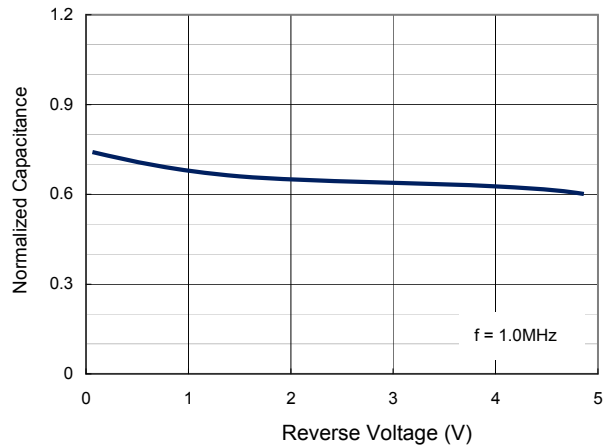
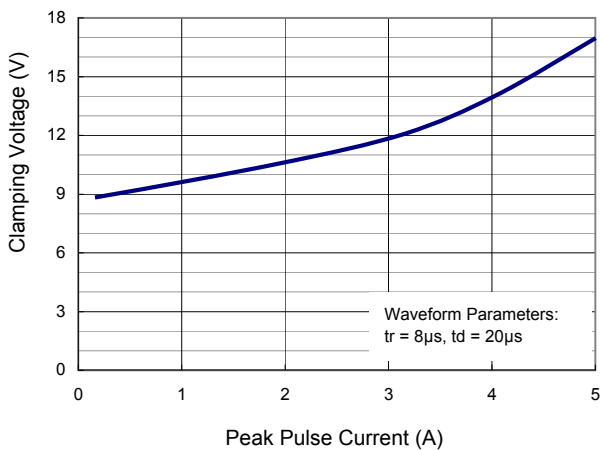

FIG 5 Clamping Voltage vs. Peak Pulse Current



Small Signal Diode

Applications Information

- ◇ Designed to protect high speed data interfaces
- ◇ Designed to protect four data lines from transient over-voltages by clamping them to a fixed reference
- ◇ Designed to protect sensitive components which are connected to data and transmission lines from overvoltage caused by electrostatic discharge (ESD), electrical fast transients (EFT), and lightning.
- ◇ TESDS5V0ALC incorporates eight surge rated, low capacitance steering diodes and a TVS diode in a single package
- ◇ During transient conditions, the steering diodes direct the transient to either the positive side of the power supply line or to ground
- ◇ The internal TVS diode prevents over-voltage on the power line, protecting any downstream components

Circuit Board Layout Recommendations

- ◇ To protect data lines and the power line, connect pin 5 directly to the VDD. In this configuration the data lines are referenced to the supply voltage. The internal TVS diode prevents over-voltage on the supply rail.
- ◇ The TESDS5V0ALC can be isolated from the power supply by adding a series resistor between pin 5 and VDD. A value of 100kΩ is recommended. The internal TVS and steering diodes remain biased, providing the advantage of lower capacitance.

²In applications where no positive supply reference is available, or complete supply isolation is desired, the internal TVS may be used as the reference. In this case, pin 5 is not connected. The steering diodes will begin to conduct when the voltage

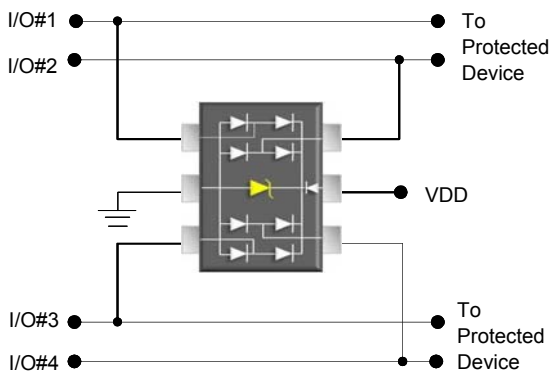

◇ Data Line and Power Supply Protection Using Vcc as reference

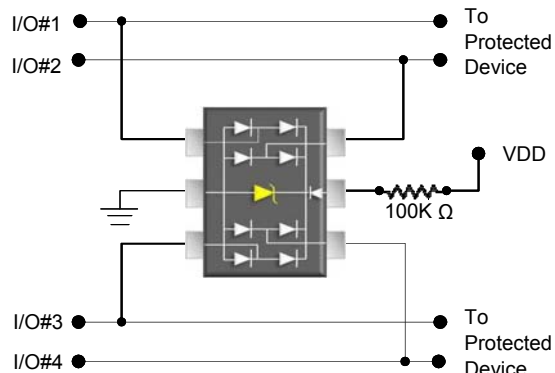

◇ Data Line Protection with Bias and Power Supply Isolator

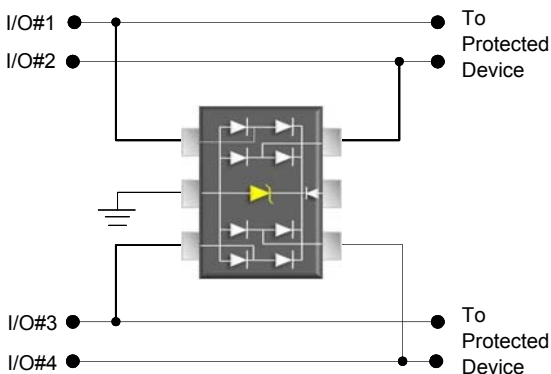

◇ Data Line Protection Using Internal TVS Diode as Reference

Small Signal Diode

Tape & Reel specification

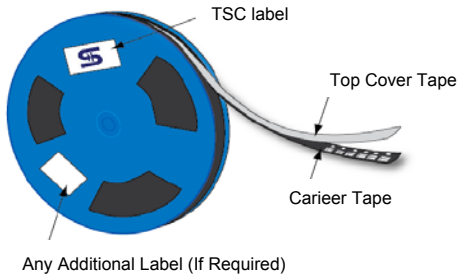

Item	Symbol	Dimension (mm)
Carrier depth	K	1.22 Max.
Sprocket hole	D	1.50 +0.10
Reel outside diameter	A	180 ± 1
Reel inner diameter	D1	50 Min.
Feed hole width	D2	13.0 ± 0.5
Sprocket hole position	E	1.75 ± 0.10
Sprocket hole pitch	P0	4.00 ± 0.10
Embossment center	P1	2.00 ± 0.10
Overall tape thickness	T	0.6 Max.
Tape width	W	8.30 Max.
Reel width	W1	14.4 Max.

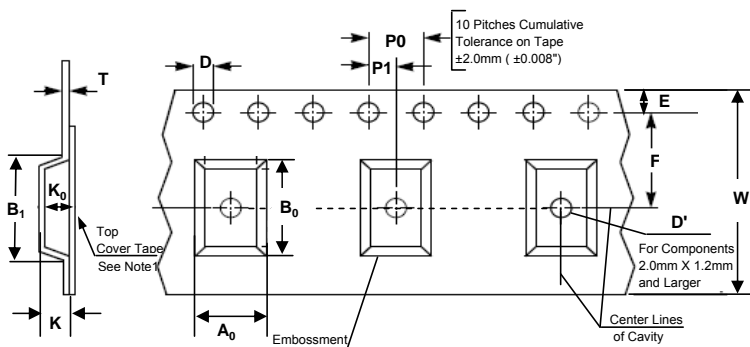

For Machine Reference Only
Including Draft and RADLL
Concentric Around B₀

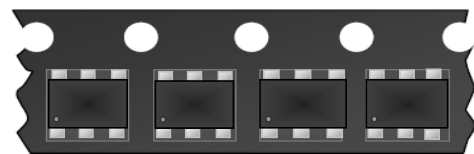
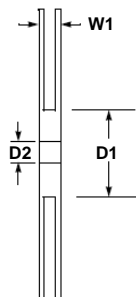
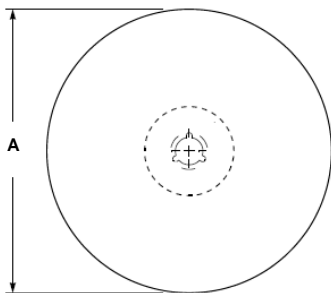

Direction of Feed →

Suggested PAD Layout

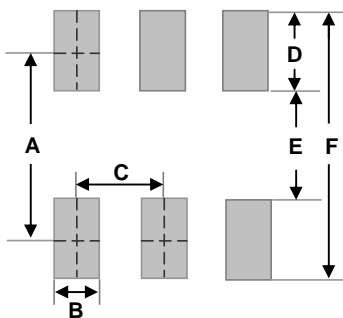

Dimensions	Unit (inch)	Unit (mm)
A	0.098	2.50
B	0.024	0.60
C	0.037	0.95
D	0.043	1.10
E	0.055	1.40
F	0.142	3.60

Note 1: A₀, B₀, and K₀ are determined by component size. The clearance between the components and the cavity must be within 0.05 mm min. to 0.5 mm max. The component cannot rotate more than 10° within the determined cavity.

Note 2: If B₁ exceeds 4.2 mm(0.165") for 8 mm embossed tape, the tape may not feed through all tape feeders.

Note 3: The suggested land pattern dimensions have been provided for reference only, as actual pad layouts may vary depending on application.