

Small Signal Diode

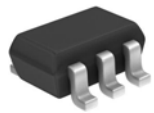

Features

- ✧ Meet IEC61000-4-2 (ESD) ±15kV (air), ±8kV (contact)
- ✧ Meet IEC61000-4-4 (EFT) rating. 40A (5/50ns)
- ✧ Protects four high speed I/O lines
- ✧ Working Voltage : 5V
- ✧ Pb free version, RoHS compliant, and Halogen free

Mechanical Data

- ✧ Case : SOT-363 standard package, molded plastic
- ✧ Terminal: Matte tin plated, lead free, solderable per MIL-STD-202, Method 202 guaranteed
- ✧ High temperature soldering guaranteed: 260°C/10s
- ✧ Molding Compound Flammability Rating : UL 94V-O
- ✧ Weight :8 mg (approximately)
- ✧ Marking Code : B54

Applications

- ✧ USB Power & Data Line Protection
- ✧ Notebooks, Desktops, Servers and Video Graphics Cards
- ✧ Monitors and Flat Panel Displays
- ✧ Portable Instrumentation
- ✧ Set Top Box

Ordering Information

Part No.	Package	Packing	Packing Code	Marking
TESDV5V0A	SOT-363	3K / 7" Reel	RFG	B54

Maximum Ratings and Electrical Characteristics

Rating at 25°C ambient temperature unless otherwise specified.

Maximum Ratings

Type Number	Symbol	Value	Units
Peak Pulse Power (tp=8/20µs waveform)	P _{PP}	150	W
Peak Pulse Current (tp = 8/20µs)	I _{PP}	3	A
ESD per IEC 61000-4-2 (Air) ESD per IEC 61000-4-2 (Contact)	V _{ESD}	±16 ±8	KV
Junction and Storage Temperature Range	T _J , T _{STG}	-55 to + 150	°C

Electrical Characteristics

Type Number	Symbol	Min	Max	Units
Reverse Stand-Off Voltage	V _{RWM}	-	5	V
Reverse Breakdown Voltage	V _(BR)	6	-	V
Reverse Leakage Current	I _R	-	1	µA
Clamping Voltage	V _C	I _{PP} = 1A	15	V
		I _{PP} = 3A	25	
Junction Capacitance	C _J	2 (Typ.)		pF

SOT-363

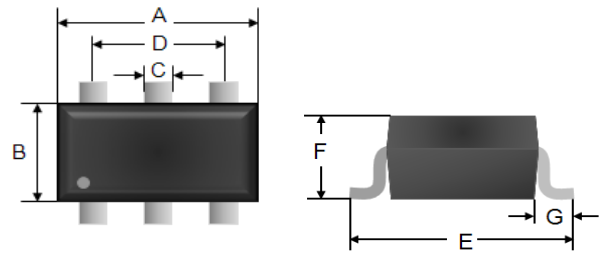

Dimensions	Unit (mm)		Unit (inch)	
	Min	Max	Min	Max
A	1.80	2.00	0.071	0.079
B	1.15	1.35	0.045	0.053
C	0.15	0.30	0.006	0.012
D	1.30 BSC		0.051 BSC	
E	2.10 BSC		0.083 BSC	
F	-	1.10	-	0.043
G	0.42		0.017	

Pin Configuration

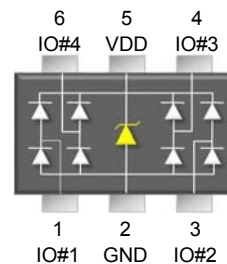

Small Signal Diode

Rating and Characteristic Curves

FIG 1 Non-Repetitive Peak Pulse Power vs. Pulse Time

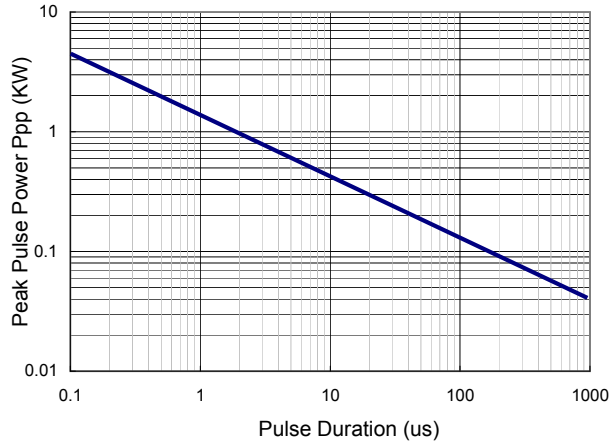

FIG 2 Pulse Waveform

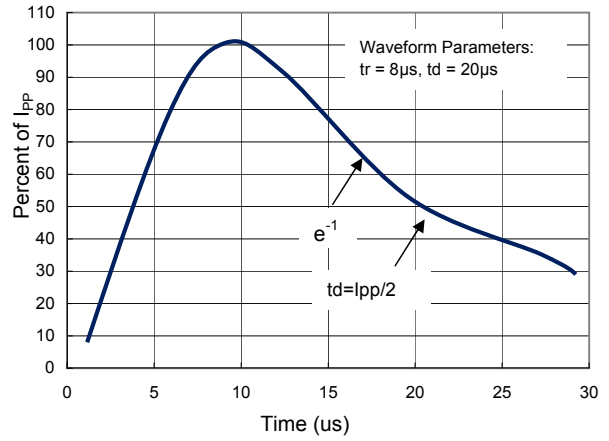

FIG 3 Admissible Power Dissipation Curve

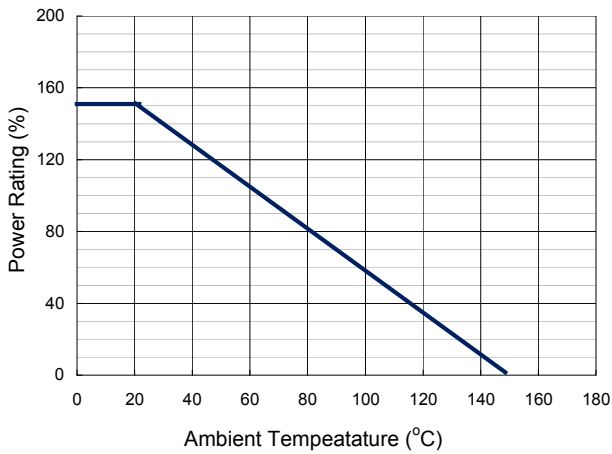

FIG 4 Typical Junction Capacitance

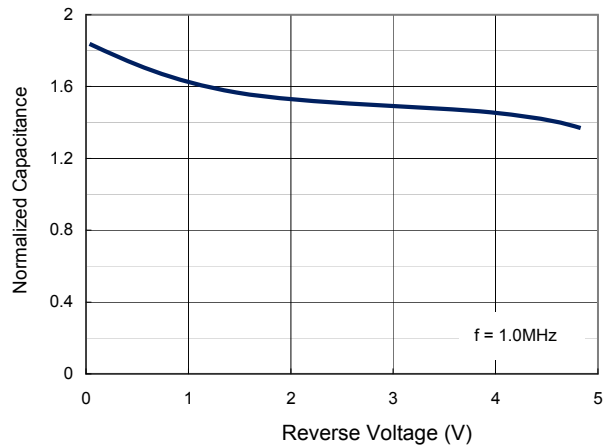
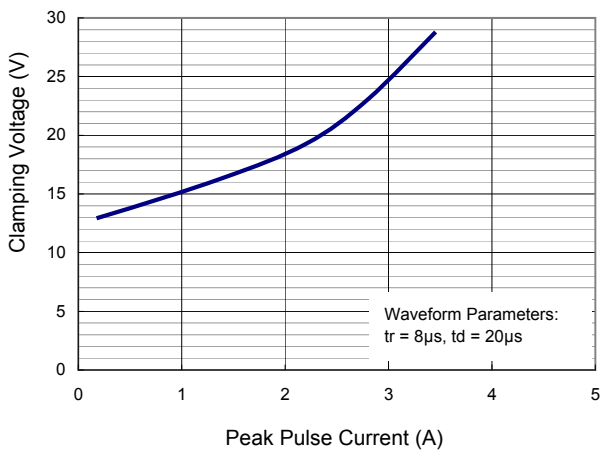

FIG 5 Clamping Voltage vs. Peak Pulse Current



Small Signal Diode

Applications Information

- ◇ Designed to protect high speed data interfaces
- ◇ Designed to protect four data lines from transient over-voltages by clamping them to a fixed reference
- ◇ Designed to protect sensitive components which are connected to data and transmission lines from overvoltage caused by electrostatic discharge (ESD), electrical fast transients (EFT), and lightning.
- ◇ TESDS5V0ALC incorporates eight surge rated, low capacitance steering diodes and a TVS diode in a single package
- ◇ During transient conditions, the steering diodes direct the transient to either the positive side of the power supply line or to ground
- ◇ The internal TVS diode prevents over-voltage on the power line, protecting any downstream components

Circuit Board Layout Recommendations

- ◇ To protect data lines and the power line, connect pin 5 directly to the VDD. In this configuration the data lines are referenced to the supply voltage. The internal TVS diode prevents over-voltage on the supply rail.
- ◇ The TESDS5V0ALC can be isolated from the power supply by adding a series resistor between pin 5 and VDD. A value of 100kΩ is recommended. The internal TVS and steering diodes remain biased, providing the advantage of lower capacitance.

²In applications where no positive supply reference is available, or complete supply isolation is desired, the internal TVS may be used as the reference. In this case, pin 5 is not connected. The steering diodes will begin to conduct when the voltage

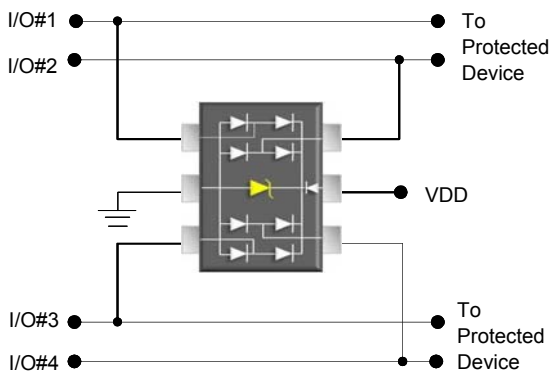

◇ Data Line and Power Supply Protection Using Vcc as reference

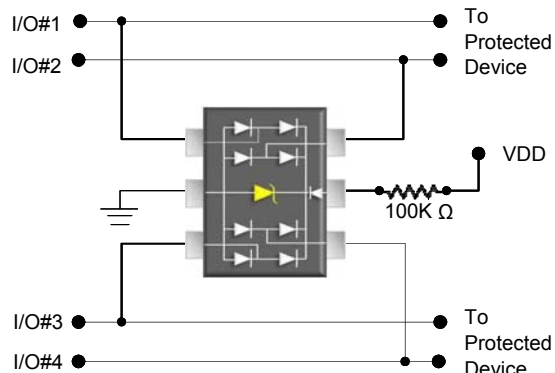

◇ Data Line Protection with Bias and Power Supply Isolation

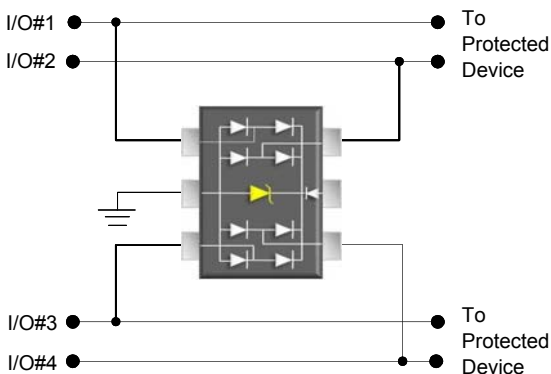

◇ Data Line Protection Using Internal TVS Diode as Reference

Small Signal Diode

Tape & Reel specification

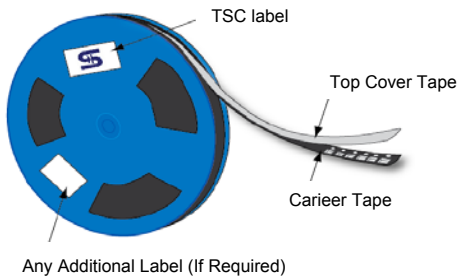

Item	Symbol	Dimension (mm)
Carrier depth	K	1.22 Max.
Sprocket hole	D	1.50 +0.10
Reel outside diameter	A	180 ± 1
Reel inner diameter	D1	50 Min.
Feed hole width	D2	13.0 ± 0.5
Sprocket hole position	E	1.75 ±0.10
Sprocket hole pitch	P0	4.00 ±0.10
Embossment center	P1	2.00 ±0.10
Overall tape thickness	T	0.6 Max.
Tape width	W	8.30 Max.
Reel width	W1	14.4 Max.

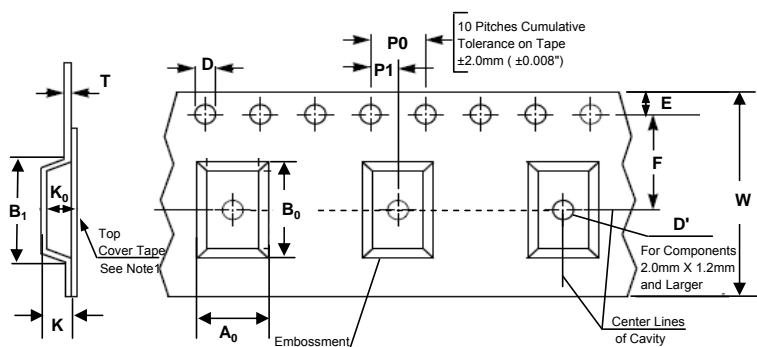

For Machine Reference Only Including Draft and RADLL Concentric Around B₀

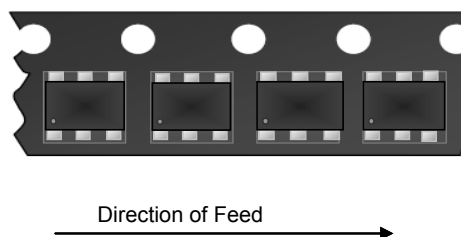
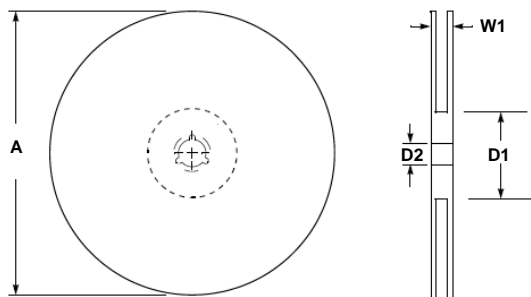

Suggested PAD Layout

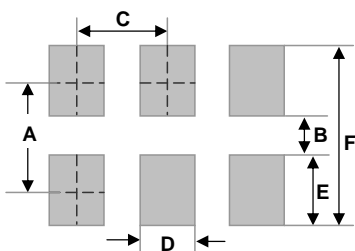

Dimensions	Unit (inch)	Unit (mm)
A	0.073	1.85
B	0.039	1.00
C	0.026	0.65
D	0.016	0.40
E	0.033	0.85
F	0.106	2.70

Note 1: A₀, B₀, and K₀ are determined by component size. The clearance between the components and the cavity must be within 0.05 mm min. to 0.5 mm max. The component cannot rotate more than 10° within the determined cavity.

Note 2: If B₁ exceeds 4.2 mm(0.165") for 8 mm embossed tape, the tape may not feed through all tape feeders.

Note 3: The suggested land pattern dimensions have been provided for reference only, as actual pad layouts may vary depending on application.