

TV30C5V0 Thru TV30C171

Working Peak Reverse Voltage: 5.0 - 170 Volts
Power Dissipation: 3000 Watts

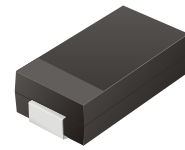

Features

- Ideal for surface mount applications
- Easy pick and place
- Plastic package has Underwriters Lab. flammability classification 94V-0
- Typical IR less than 1uA above 10V
- Fast reponse time: typically less 1nS for uni-direction, less than 5nS for bi-directiona, from 0 V to BV min.

Mechanical data

- Case: JEDEC DO-214AB molded plastic
- Terminals: solderable per MIL-STD-750, method 2026
- Polarity: Cathode band denoted
- Mounting position: Any
- Approx. Weight:0.21 gram

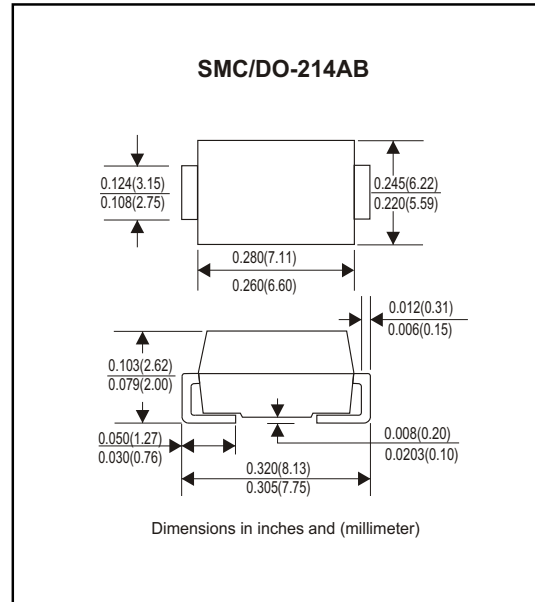

Maximum Ratings and Electrical Characteristics

Rating at 25°C ambient temperature unless otherwise specified.
Single phase, half wave, 60Hz, resistive or inductive load.
For capacitive load, derate current by 20%

Characteristics	Symbol	Value	Units
Peak Power Dissipation on 10/1000uS Waveform (Note 1, Fig. 1)	PPPM	3000	Watts
Peak Pulse Current of on 10/1000uS Waveform (Note 1, Fig. 3)	IPPM	See Table 1	A
Steady State PowerDissipation at TL=75° C (Note2)	PM(AV)	5.0	Watts
Peak Forfard Surge Current, 8.3mS Single Half Sine-Wave Superimposed on Rated Load, Uni-Directional Only (Note 3)	IFSM	250	A
Maxinum Instantaneous Forward Voltage at 100A for Uni-Directional only (Note 3 & 4)	VF	3.5/5.0	Volts
Operation Junction Temperature Range	Tj	-55 to +150	°C
Storage Temperature Range	TSTG	-55 to +150	°C

Note: 1. Non-Repetitive Current Pulse, per Fig. 3 and Derated above TA=25° C, per Fig. 2.
2. Mounted on 8.0x8.0 mm². Copper Pads to Each Terminal.
3. Measured on 8.3 mS Single Half Sine-Wave or Equivalent Square Wave, Duty Cycle=4 Pulse per Minute Maximum.
4. VF=3.5V on TV30C5V0 thru TV30C900 Devices and VF=5.0V on TV30C101 thru TV30C171.

Rating and Characteristic Curves (TV30C5V0 Thru TV30C171)

Fig. 1 - Reverse Characteristics

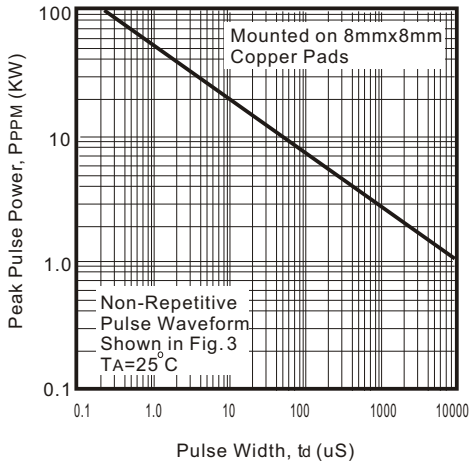

Fig. 2 - Pulse Derating Curve

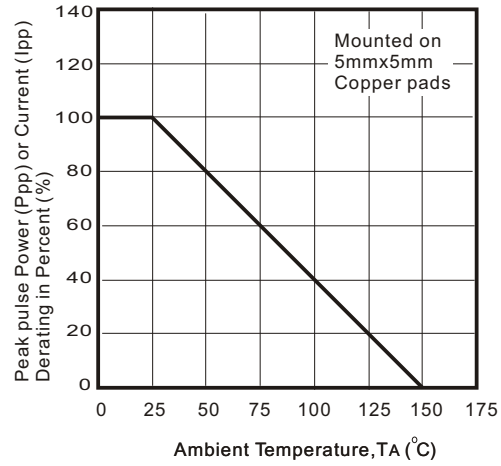

Fig. 3 - Pulse Waveform

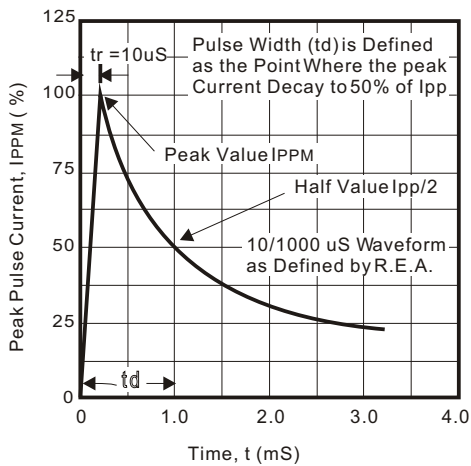

Fig. 4 - Typical Junction Capacitance

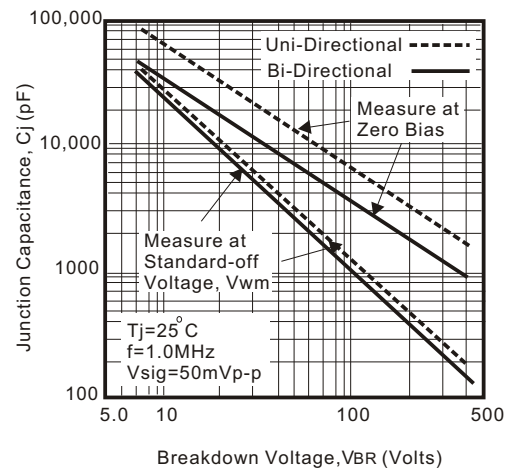

Fig. 5 - Steady State Power Derating Curve

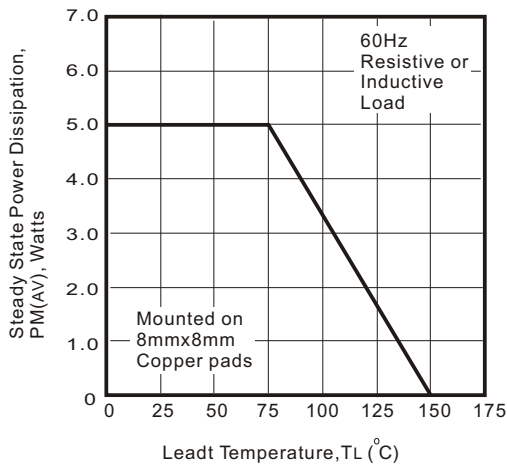

Fig. 6 - Maximum Non-Repetitive Peak Forward Surge Current (Uni-Directional Only)

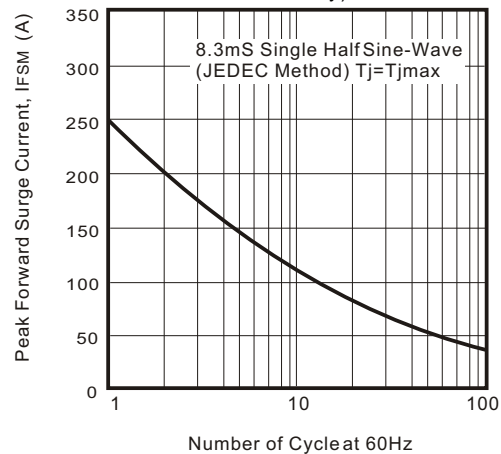

Table 1. Specification

Part No.	Absolute Maximum Rating (Ta=25°C)					Electrical Characteristics (Ta=25°C)				
	VRWM (V)	VBR Min (V)	VBR Max (V)	IT (mA)	IFSM (A) @8.3ms	Max Vc		IR @VRWM (uA)	Marking Code	
						(V)	Ipp(A)		UNI	BI
TV30C5V0K(B)	5.00	6.40	7.55	10	250	9.6	312.5	1000	HDD	IDD
TV30C5V0J(B)	5.00	6.40	7.25	10	250	9.2	326.0	1000	HDE	IDE
TV30C6V0K(B)	6.00	6.67	8.45	10	250	11.4	263.2	1000	HDF	IDF
TV30C6V0J(B)	6.00	6.67	7.67	10	250	10.3	291.3	1000	HDG	IDG
TV30C6V5K(B)	6.50	7.22	9.14	10	250	12.3	243.9	500	HDH	IDH
TV30C6V5J(B)	6.50	7.22	8.30	10	250	11.2	267.9	500	HDK	IDK
TV30C7V0K(B)	7.00	7.78	9.86	1	250	13.3	225.6	200	HDL	IDL
TV30C7V0J(B)	7.00	7.78	8.95	1	250	12.0	250.0	200	HDM	IDM
TV30C7V5K(B)	7.50	8.33	10.67	1	250	14.3	209.8	100	HDN	IDN
TV30C7V5J(B)	7.50	8.33	9.58	1	250	12.9	232.6	100	HDP	IDP
TV30C8V0K(B)	8.00	8.89	11.30	1	250	15.0	200.0	50	HDQ	IDQ
TV30C8V0J(B)	8.00	8.89	10.23	1	250	13.6	220.6	50	HDR	IDR
TV30C8V5K(B)	8.50	9.44	11.9	1	250	15.9	188.8	25	HDS	IDS
TV30C8V5J(B)	8.50	9.44	10.8	1	250	14.4	208.4	25	HDT	IDT
TV30C9V0K(B)	9.00	10.00	12.6	1	250	16.9	177.4	10	HDU	IDU
TV30C9V0J(B)	9.00	10.00	11.5	1	250	15.4	194.8	10	HDV	IDV
TV30C100K(B)	10.00	11.10	14.1	1	250	18.8	159.6	5	HDW	IDW
TV30C100J(B)	10.00	11.10	12.8	1	250	17.0	176.4	5	HDX	IDX
TV30C110K(B)	11.00	12.20	15.4	1	250	20.1	149.2	5	HDY	IDY
TV30C110J(B)	11.00	12.20	14.0	1	250	18.2	184.8	5	HDZ	IDZ
TV30C120K(B)	12.00	13.30	16.9	1	250	22.0	136.4	5	HED	IED
TV30C120J(B)	12.00	13.30	15.3	1	250	19.9	150.6	5	HEE	IEE
TV30C130K(B)	13.00	14.40	18.2	1	250	23.8	126.0	5	HEF	IEF
TV30C130J(B)	13.00	14.40	16.5	1	250	21.5	139.4	5	HEG	IEG
TV30C140K(B)	14.00	15.60	19.8	1	250	25.8	116.2	5	HEH	IEH
TV30C140J(B)	14.00	15.60	17.9	1	250	23.2	129.4	5	HEK	IEK
TV30C150K(B)	15.00	16.70	21.1	1	250	26.9	111.6	5	HEL	IEL
TV30C150J(B)	15.00	16.70	19.2	1	250	24.4	123.0	5	HEM	IEM
TV30C160K(B)	16.00	17.80	22.6	1	250	28.8	104.2	5	HEN	IEN
TV30C160J(B)	16.00	17.80	20.5	1	250	26.0	115.4	5	HEP	IEP
TV30C170K(B)	17.00	18.90	23.9	1	250	30.5	98.4	5	HEQ	IEQ
TV30C170J(B)	17.00	18.90	21.7	1	250	27.6	106.6	5	HER	IER
TV30C180K(B)	18.00	20.00	25.3	1	250	32.2	93.2	5	HES	IES
TV30C180J(B)	18.00	20.00	23.3	1	250	29.2	102.8	5	HET	IET
TV30C200K(B)	20.00	22.20	28.1	1	250	35.8	83.8	5	HEU	IEU
TV30C200J(B)	20.00	22.20	25.5	1	250	32.4	92.6	5	HEV	IEV
TV30C220K(B)	22.00	24.40	30.9	1	250	39.4	76.2	5	HEW	IEW
TV30C220J(B)	22.00	24.40	28.0	1	250	35.5	84.4	5	HEX	IEX
TV30C240K(B)	24.00	26.70	33.8	1	250	43.0	69.8	5	HEY	IEY
TV30C240J(B)	24.00	26.70	30.7	1	250	38.9	77.2	5	HEZ	IEZ
TV30C260K(B)	26.00	28.90	36.6	1	250	46.6	64.4	5	HFD	IFD
TV30C260J(B)	26.00	28.90	33.2	1	250	42.1	71.2	5	HFE	IFE
TV30C280K(B)	28.00	31.10	39.4	1	250	50.0	60.0	5	HFF	IFF
TV30C280J(B)	28.00	31.10	35.8	1	250	45.4	66.0	5	HFG	IFG
TV30C300K(B)	30.00	33.30	42.2	1	250	53.5	56.0	5	HFH	IFH
TV30C300J(B)	30.00	33.30	38.3	1	250	48.4	62.0	5	HFK	IFK
TV30C330K(B)	33.00	36.70	46.5	1	250	59.0	50.4	5	HFL	IFL
TV30C330J(B)	33.00	36.70	42.2	1	250	53.3	56.2	5	HFM	IFM
TV30C360K(B)	36.00	40.00	50.7	1	250	64.3	46.6	5	HFN	IFN
TV30C360J(B)	36.00	40.00	46.0	1	250	58.1	51.6	5	HFP	IFP
TV30C400K(B)	40.00	44.40	56.3	1	250	71.4	42.0	5	HFQ	IFQ
TV30C400J(B)	40.00	44.40	51.1	1	250	64.5	46.4	5	HFR	IFR
TV30C430K(B)	43.00	47.80	60.5	1	250	76.7	39.2	5	HFS	IFS
TV30C430J(B)	43.00	47.80	54.9	1	250	69.4	43.2	5	HFT	IFT
TV30C450K(B)	45.00	50.00	63.3	1	250	80.3	37.4	5	HFU	IFU
TV30C450J(B)	45.00	50.00	57.5	1	250	72.7	41.2	5	HFV	IFV

Part No.	Absolute Maximum Rating (Ta=25°C)					Electrical Characteristics (Ta=25°C)				
	VRWM (V)	VBR Min (V)	VBR Max (V)	IT (mA)	IFSM (A) @8.3mS	Max Vc		IR @VRWM (uA)	Marking Code	
						(V)	Ipp(A)		UNI	BI
TV30C480K(B)	48.00	53.30	67.5	1	250	85.5	35.0	5	HFW	IFW
TV30C480J(B)	48.00	53.30	61.3	1	250	77.4	38.8	5	HFX	IFX
TV30C510K(B)	51.00	56.70	71.8	1	250	91.1	37.0	5	HFY	IFY
TV30C510J(B)	51.00	56.70	65.2	1	250	82.4	36.4	5	HFZ	IFZ
TV30C540K(B)	54.00	60.00	76.0	1	250	96.3	31.2	5	HGD	IGD
TV30C540J(B)	54.00	60.00	69.0	1	250	87.1	34.4	5	HGE	IGE
TV30C580K(B)	58.00	64.40	81.6	1	250	103.0	39.2	5	HGF	IGF
TV30C580J(B)	58.00	64.40	74.1	1	250	93.6	32.0	5	HGG	IGG
TV30C600K(B)	60.00	66.70	84.5	1	250	107.0	28.0	5	HGH	IGH
TV30C600J(B)	60.00	66.70	76.7	1	250	96.8	31.0	5	HGK	IGK
TV30C640K(B)	64.00	71.10	90.1	1	250	114.0	26.4	5	HGL	IGL
TV30C640J(B)	64.00	71.10	81.8	1	250	103.0	29.2	5	HGM	IGM
TV30C700K(B)	70.00	77.80	98.6	1	250	125.0	24.0	5	HGN	IGN
TV30C700J(B)	70.00	77.80	89.5	1	250	113.0	26.6	5	HGP	IGP
TV30C750K(B)	75.00	83.30	105.7	1	250	134.0	22.4	5	HGQ	IGQ
TV30C750J(B)	75.00	83.30	95.8	1	250	121.0	24.8	5	HGR	IGR
TV30C780K(B)	78.00	86.70	109.8	1	250	139.0	21.6	5	HGS	IGS
TV30C780J(B)	78.00	86.70	99.7	1	250	126.0	22.8	5	HGT	IGT
TV30C850K(B)	85.00	94.40	119.2	1	250	151.0	19.8	5	HGU	IGU
TV30C850J(B)	85.00	94.40	108.2	1	250	137.0	20.8	5	HGV	IGV
TV30C900K(B)	90.00	100.00	126.5	1	250	160.0	18.8	5	HGW	IGW
TV30C900J(B)	90.00	100.00	115.5	1	250	146.0	20.6	5	HGX	IGX
TV30C101K(B)	100.00	111.00	141.0	1	250	179.0	16.6	5	HGY	IGY
TV30C101J(B)	100.00	111.00	128.0	1	250	162.0	18.6	5	HGZ	IGZ
TV30C111K(B)	110.00	122.00	154.5	1	250	196.0	15.4	5	HHH	IHH
TV30C111J(B)	110.00	122.00	140.5	1	250	177.0	16.8	5	HHE	IHE
TV30C121K(B)	120.00	133.00	169.0	1	250	214.0	14.0	5	HHF	IHF
TV30C121J(B)	120.00	133.00	153.0	1	250	193.0	15.6	5	HHG	IHG
TV30C131K(B)	130.00	144.00	182.5	1	250	231.0	13.0	5	HHH	IHH
TV30C131J(B)	130.00	144.00	165.5	1	250	209.0	14.4	5	HHK	IHK
TV30C151K(B)	150.00	167.00	211.5	1	250	268.0	11.2	5	HHL	IHL
TV30C151J(B)	150.00	167.00	192.5	1	250	243.0	12.4	5	HHM	IHM
TV30C161K(B)	160.00	178.00	226.0	1	250	287.0	10.4	5	HHN	IHN
TV30C161J(B)	160.00	178.00	205.0	1	250	259.0	11.6	5	HHP	IHP
TV30C171K(B)	170.00	189.00	239.5	1	250	304.0	9.8	5	HHQ	IHQ
TV30C171J(B)	170.00	189.00	217.5	1	250	275.0	11.0	5	HHR	IHR

Note:

- 1) Suffix K denotes 10% tolerance devices, suffix J denotes 5% tolerance devices.
- 2) Suffix B after part number to specify bi-directional devices.
- 3) For bi-directional devices having VR of 10 volts and under, the IR limit is double.