

High Voltage rectifiers Hochspannungs- gleichrichter

Edition 97

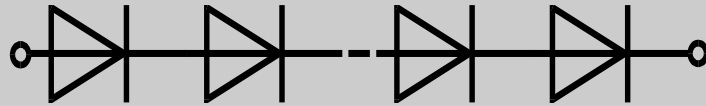

Reg. Nr. 2743-02

 IXYS

Symbols and Definitions

a	Acceleration
$I_{F(AV)M}$	Maximum mean forward current
$I_{F(RMS)}$	Maximum RMS forward current
I_{FSM}	Surge forward current
I_R	Repetitive peak reverse current
M_d	Mounting torque
P_{RSM}	Maximum surge reverse power dissipation
r_T	Forward slope resistance (for power loss calculations only)
T_{amb}	Ambient temperature or temperature of the cooling medium
T_{stg}	Storage temperature
T_(vj)	Virtual junction temperature
V_{dT}	DC voltage at $V_{V(RMS)}$ arithmetic mean
V_F	Forward voltage
V_{RRM}	Maximum repetitive peak reverse voltage
$V_{V(RMS)}$	Supply voltage, RMS value
V_{TO}	Threshold voltage (for power loss calculations only)

Kurzzeichen und Begriffe

a	Rüttelfestigkeit
$I_{F(AV)M}$	Maximaler Durchlaßstrom-Mittelwert
$I_{F(RMS)}$	Höchstzulässiger Effektiv-Durchlaßstrom
I_{FSM}	Maximaler Stoßstrom
I_R	Sperrstrom
M_d	Anzugsdrehmoment
P_{RSM}	Maximale Stoßsperrverlustleistung
r_T	Ersatzwiderstand (nur zur Berechnung der Verlustleistung)
T_{amb}	Umgebungstemperatur oder Kühlmitteltemperatur
T_{stg}	Lagertemperatur
T_(vj)	Sperrschichttemperatur
V_{dT}	Typgleichspannung bei $V_{V(RMS)}$ arithm. Mittelwert
V_F	Durchlaßspannung
V_{RRM}	Höchstzul. periodische Spitzensperrspannung
$V_{V(RMS)}$	Typische Anschlußspannung (Effektivwert)
V_{TO}	Schleusenspannung (nur zur Berechnung der Verlustleistung)

Nomenclature for High Voltage Rectifiers

Example: UGE 0421 AY4

U	High Voltage rectifier, U-Series
G	Uncontrolled rectifier
E	One way circuit
B	One phase bridge circuit
D	Three phase bridge circuit
	Code, number of power semiconductors
0	1- 4
1	5- 6
2	7-12
4	Code, max. average forward current in A 1 ≤ 3 A; 2 ≤ 12 A; 3 ≤ 16 A; 4 ≤ 33 A etc.
2	Code, type of built in power semiconductors
1	Code, max. RMS voltage 1 ≥ 1 KV; 2 ≥ 2 KV; 3 ≥ 3 KV etc.
A	Letter, A = avalanche diode
Y4	Version (see dimension drawing) Y4 = round housing, A-N = plastic housing

Beispiel: UGE 0421 AY4

U	Hochspannungs-Gleichrichter, Baureihe U
G	Ungesteuerter Gleichrichter
E	Einwegschaltung
B	Einphasen-Brückenschaltung
D	Dreiphasen-Brückenschaltung
	Kennziffer, Anzahl der Leistungshalbleiter
0	1- 4
1	5- 6
2	7-12
4	Kennziffer, Dauergrenzstrom in A 1 ≤ 3 A; 2 ≤ 12 A; 3 ≤ 16 A; 4 ≤ 33 A usw.
2	Kennziffer, Art der eingebauten Dioden
1	Kennziffer, Anschlußspannung 1 ≥ 1 KV; 2 ≥ 2 KV; 3 ≥ 3 KV usw.
A	Buchstabe, A = Avalanche-Diode
Y4	Gehäusebauform (siehe Maßbild) Y4 = runder Becher, A-N = Kunststoff-
	becher

Contents/Inhalt

Page
Seite

Symbols and Definitions / Kurzzeichen und Begriffe

2

Circuit configuration Schaltbild	Type Typ	V_{RRM} V	$V_{V(RMS)}$ V	$I_{F(AV)M}$ A	I_{FSM} 45°C 10 ms A	
 UGB	UGB 3132 AD	4800	2250	1.3	60	3
	UGB 6124 AG	10500	5000	1.0	50	3
 UGD	UGD 6123 AG	7200	3300	1.8	50	3
	UGD 8124 AG	10500	5000	1.2	50	3
 UGE	UGE 0421 AY4	3200	1125	23/7.4	300	4 - 5
	UGE 0221 AY4	4800	1750	10/3.8	180	6 - 7
	UGE 1112 AY4	8000	3000	4.2/2.0	120	8 - 9
	UGE 3126 AY4	24000	9000	2.0/0.8	70	10 - 11

Technical data, application notes / Technische Daten, Applikationshinweise

12 - 13

Mounting instructions / Montagehinweise

15 - 15

IXYS International Sales Representatives

16

1~ / 3~ High Voltage Rectifier Modules Hochspannungs-Gleichrichter-Module

Typ	V_{RRM} V	$V_{V(RMS)}$ V	$I_{F(AV)M}$ A	I_{FSM} 45°C 10 ms A	$T_{(vj)m}$ °C	Weight Gewicht	Dimensions Maßbild
UGB 3132 AD	4800	2250	1.3	60	150	150	1
UGB 6124 AG	10500	5000	1.0	50	150	300	1
UGD 6123 AG	7200	3300	1.8	50	150	300	2
UGD 8124 AG	10500	5000	1.2	50	150	300	2

Typ	a	b	c	d	e	f	g	h	i	k
UGB 3132 AD	80	70	57	58.5	260	6	15	15	15	
UGB 6124 AG	135	125	112	58.5	260	11	32.5	25	32.5	
UGB 6123 AG	135	125	112	58.5	260	8	30	18	18	30
UGB 8124 AG	135	125	112	58.5	260	8	30	18	18	30

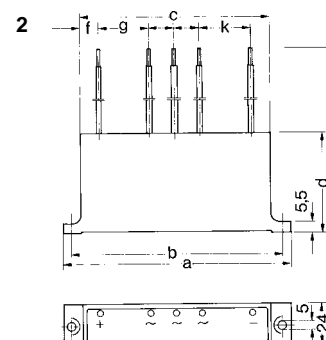
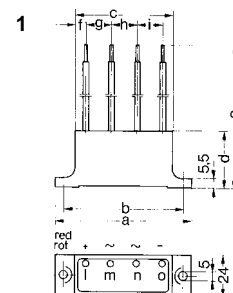

High Voltage Rectifiers

Hochspannungsgleichrichter

$$V_{RRM} = 3200 \text{ V}$$

$$V_{dT} = 500 \text{ V}$$

$$I_{F(AV)M} = 22.9 \text{ A}$$

V_{RRM} V	$V_{V(RMS)}$ V	V_{dT} V	Standard Types	Power Designation
3200	1125	500	UGE 0421 AY4	Si-E 1125 / 500-6

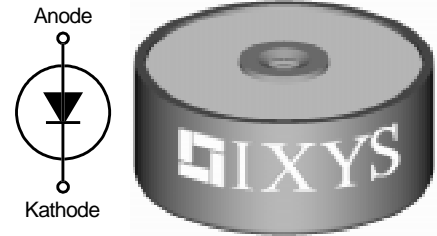

Symbol	Test Conditions	Ratings
$I_{F(RMS)}$ $I_{F(AV)M}$	air self cooling, $T_{amb} = 45^\circ\text{C}$	40 A
	- without cooling plate	7.4 A
	- with colling plate	10.9 A
	forced air cooling: $v = 3 \text{ m/s}$, $T_{amb} = 35^\circ\text{C}$	
	- without cooling plate	14.2 A
	- with cooling plate	18.8 A
	oil cooling, $T_{amb} = 35^\circ\text{C}$	
	- without cooling plate	19.7 A
	- with cooling plate	22.9 A
P_{RSM}	$T_{(vj)} = 150^\circ\text{C}$; $t_p = 10 \mu\text{s}$	7 kW
I_{FSM}	non repetitive, 50 c/s (for 60 c/s add 10%) $T_{(vj)} = 45^\circ\text{C}$; $t_p = 10 \text{ ms}$	300 A
	$T_{(vj)} = 150^\circ\text{C}$; $t_p = 10 \text{ ms}$	250 A
T_{amb}		-40...+150 °C
T_{stg}		-40...+150 °C
$T_{(vj)}$		150 °C

Weight 115 g

Symbol	Test Conditions	Characteristic Values
I_R	$T_{(vj)} = 150^\circ\text{C}$; $V_R = V_{RRM}$	$\leq 2 \text{ mA}$
V_F	$I_F = 55 \text{ A}$ $T_{(vj)} = 25^\circ\text{C}$	2.72 V
V_{TO}	$T_{(vj)} = 150^\circ\text{C}$	1.7 V
r_T	$T_{(vj)} = 150^\circ\text{C}$	16 mΩ
a	$f = 50\text{Hz}$	5 x 9,81 m/s ²
M_d		8 Nm

Features

- Hermetically sealed Epoxy
- Use in oil
- Avalanche characteristics

Applications

- X-Ray equipment
- Electrostatic dust precipitators
- Electronic beam welding
- Lasers
- Cable test equipment

Advantages

- Simple mounting
- Improved temperature and power cycling
- Reduced protection circuits
- Series and parallel operation

Dimensions in mm (1 mm = 0.0394")

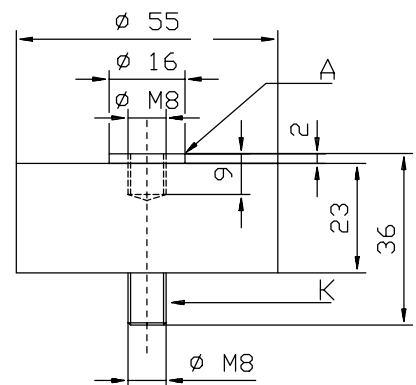

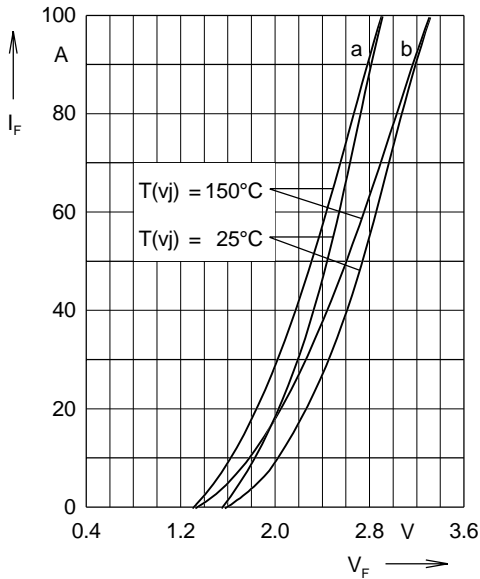

Fig. 1: Forward characteristics

Instantaneous forward current I_F as a function of instantaneous forward voltage drop V_F for junction temperature $T_{(vj)} = 25^\circ\text{C}$ and $T_{(vj)} = 150^\circ\text{C}$
 a = Mean value characteristic
 b = Limit value characteristic

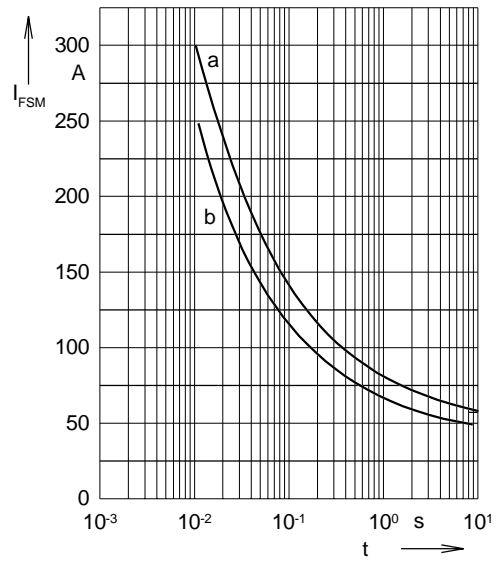

Fig. 2: Characteristics of maximum permissible current

The curves show the non repetitive peak one cycle surge forward current I_{FSM} as a function of time t and serve for rating protective devices.

a = Initial state $T_{(vj)} = 45^\circ\text{C}$
 b = Initial state $T_{(vj)} = 150^\circ\text{C}$

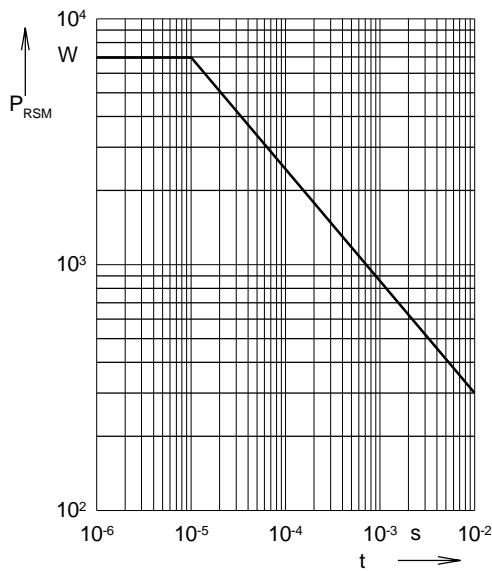

Fig. 3: Power loss

Non repetitive peak reverse power loss P_{RSM} as a function of time t , $T_{(vj)} = 150^\circ\text{C}$

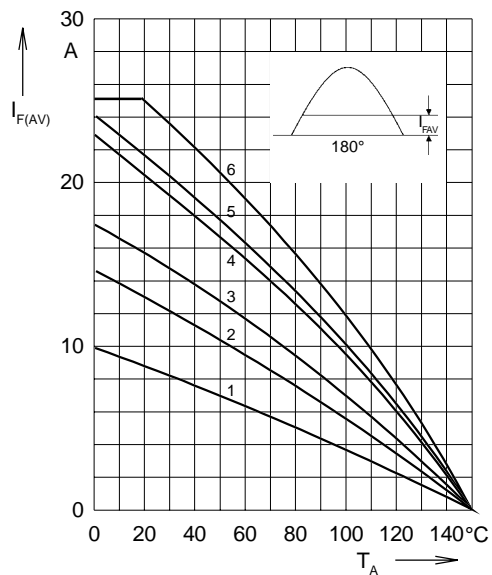

Fig. 4: Load diagramm

Mean forward current $I_{F(AV)}$ of one module for a sine half wave for various cooling modes as a function of the cooling medium temperature T_{amb} for a resistive load (horizontal mounting).

Cooling modes

- 1 = air self cooling without cooling plate
- 2 = air self cooling with cooling plate
- 3 = forced air cooling without cooling plate
- 4 = forced air cooling with cooling plate
- 5 = oil cooling without cooling plate
- 6 = oil cooling with cooling plate

High Voltage Rectifiers

Hochspannungsgleichrichter

$$V_{RRM} = 4800 \text{ V}$$

$$V_{dT} = 775 \text{ V}$$

$$I_{F(AV)M} = 10.2 \text{ A}$$

V_{RRM} V	$V_{V(RMS)}$ V	V_{dT} V	Standard Types	Power Designation
4800	1750	775	UGE 0221 AY4	Si-E 1750 / 775-4

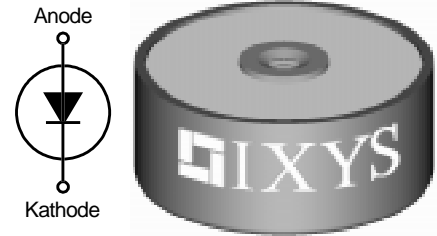

Symbol	Test Conditions	Ratings	
$I_{F(RMS)}$ $I_{F(AV)M}$	air self cooling, $T_{amb} = 45^\circ\text{C}$	- without cooling plate	3.8 A
		- with colling plate	5.4 A
	forced air cooling: $v = 3 \text{ m/s}$, $T_{amb} = 35^\circ\text{C}$	- without cooling plate	7.0 A
		- with cooling plate	10.2 A
oil cooling, $T_{amb} = 35^\circ\text{C}$	- without cooling plate	10.2 A	
	- with cooling plate	10.2 A	
P_{RSM}	$T_{(vj)} = 150^\circ\text{C}$; $t_p = 10 \mu\text{s}$	3.4	kW
I_{FSM}	non repetitive, 50 c/s (for 60 c/s add 10%) $T_{(vj)} = 45^\circ\text{C}$; $t_p = 10 \text{ ms}$	180	A
	$T_{(vj)} = 150^\circ\text{C}$; $t_p = 10 \text{ ms}$	140	A
T_{amb}		-40...+150	$^\circ\text{C}$
T_{stg}		-40...+150	$^\circ\text{C}$
$T_{(vj)}$		150	$^\circ\text{C}$

Features

- Hermetically sealed Epoxy
- Use in oil
- Avalanche characteristics

Applications

- X-Ray equipment
- Electrostatic dust precipitators
- Electronic beam welding
- Lasers
- Cable test equipment

Advantages

- Simple mounting
- Improved temperature and power cycling
- Reduced protection circuits
- Series and parallel operation

Weight 120 g

Symbol	Test Conditions	Characteristic Values	
I_R	$T_{(vj)} = 150^\circ\text{C}$; $V_R = V_{RRM}$	≤ 2	mA
V_F	$I_F = 30 \text{ A}$ $T_{(vj)} = 25^\circ\text{C}$	4.8	V
V_{TO}	$T_{(vj)} = 150^\circ\text{C}$	2.55	V
r_T	$T_{(vj)} = 150^\circ\text{C}$	90	m Ω
a	f = 50Hz	5 x 9,81	m/s ²
M_d		8	Nm

Dimensions in mm (1 mm = 0.0394")

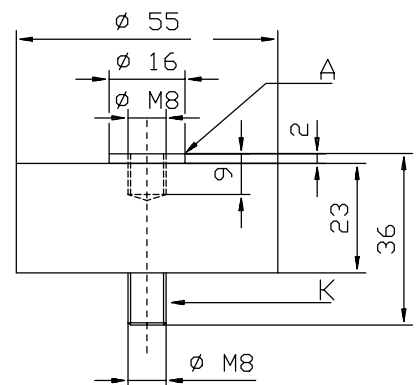

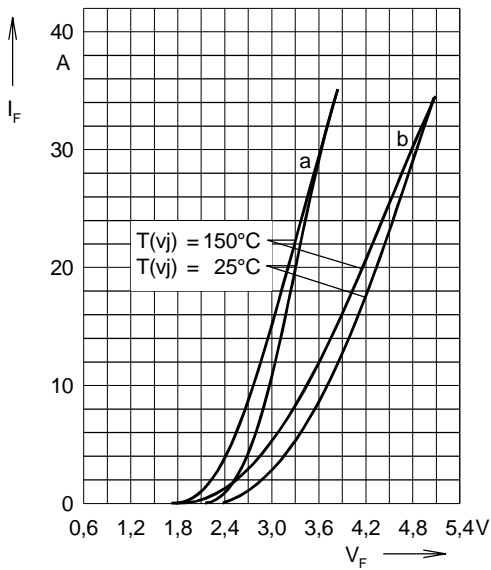

Fig. 1: Forward characteristics
 Instantaneous forward current I_F as a function of instantaneous forward voltage drop V_F for junction temperature $T_{(vj)} = 25^\circ\text{C}$ and $T_{(vj)} = 150^\circ\text{C}$
 a = Mean value characteristic
 b = Limit value characteristic

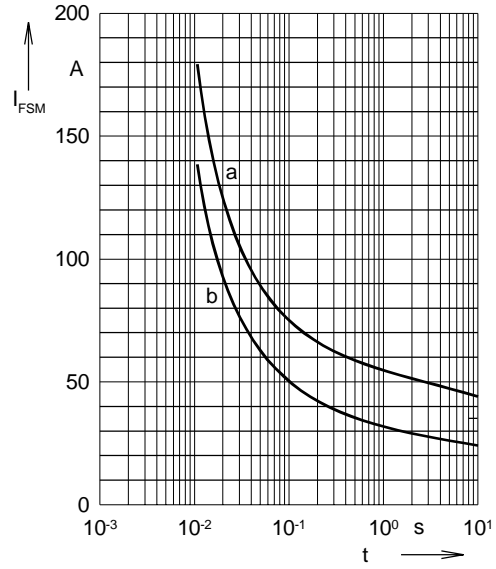

Fig. 2: Characteristics of maximum permissible current
 The curves show the non repetitive peak one cycle surge forward current I_{FSM} as a function of time t and serve for rating protective devices.
 a = Initial state $T_{(vj)} = 45^\circ\text{C}$
 b = Initial state $T_{(vj)} = 150^\circ\text{C}$

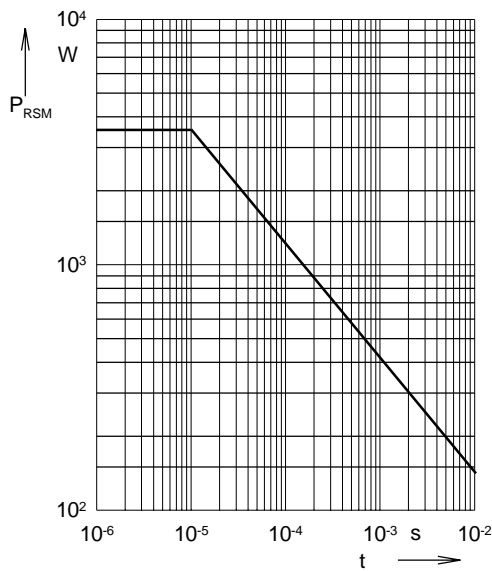

Fig. 3: Power loss
 Non repetitive peak reverse power loss P_{RSM} as a function of time t , $T_{(vj)} = 150^\circ\text{C}$

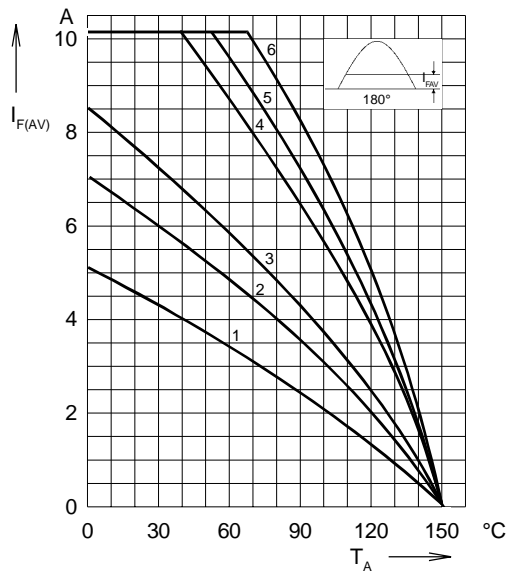

Fig. 4: Load diagramm
 Mean forward current $I_{F(AV)}$ of one module for a sine half wave for various cooling modes as a function of the cooling medium temperature T_{amb} for a resistive load (horizontal mounting).

Cooling modes

- 1 = air self cooling without cooling plate
- 2 = air self cooling with cooling plate
- 3 = forced air cooling without cooling plate
- 4 = forced air cooling with cooling plate
- 5 = oil cooling without cooling plate
- 6 = oil cooling with cooling plate

High Voltage Rectifiers

Hochspannungsgleichrichter

$$V_{RRM} = 8000 \text{ V}$$

$$V_{dT} = 1300 \text{ V}$$

$$I_{F(AV)M} = 4.2 \text{ A}$$

V_{RRM} V	$V_{V(RMS)}$ V	V_{dT} V	Standard Types	Power Designation
8000	3000	1300	UGE 1112 AY4	Si-E 3000 / 1300-2.5

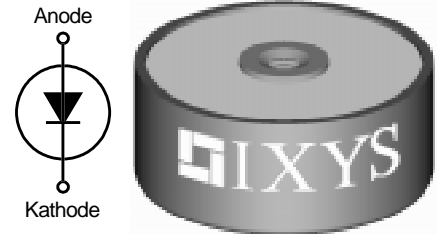

Symbol	Test Conditions	Ratings
$I_{F(RMS)}$ $I_{F(AV)M}$	air self cooling, $T_{amb} = 45^\circ\text{C}$	7 A
	- without cooling plate	2.0 A
	- with colling plate	2.5 A
	forced air cooling: $v = 3 \text{ m/s}$, $T_{amb} = 35^\circ\text{C}$	
	- without cooling plate	3.2 A
	- with cooling plate	4.1 A
	oil cooling, $T_{amb} = 35^\circ\text{C}$	
	- without cooling plate	4.2 A
	- with cooling plate	4.2 A
P_{RSM}	$T_{(vj)} = 150^\circ\text{C}$; $t_p = 10 \mu\text{s}$	2.5 kW
I_{FSM}	non repetitive, 50 c/s (for 60 c/s add 10%) $T_{(vj)} = 45^\circ\text{C}$; $t_p = 10 \text{ ms}$	120 A
	$T_{(vj)} = 150^\circ\text{C}$; $t_p = 10 \text{ ms}$	100 A
T_{amb}		-40...+150 °C
T_{stg}		-40...+150 °C
$T_{(vj)}$		150 °C

Features

- Hermetically sealed Epoxy
- Use in oil
- Avalanche characteristics

Applications

- X-Ray equipment
- Electrostatic dust precipitators
- Electronic beam welding
- Lasers
- Cable test equipment

Advantages

- Simple mounting
- Improved temperature and power cycling
- Reduced protection circuits
- Series and parallel operation

Weight 122 g

Symbol	Test Conditions	Characteristic Values
I_R	$T_{(vj)} = 150^\circ\text{C}$; $V_R = V_{RRM}$	$\leq 1 \text{ mA}$
V_F	$I_F = 7 \text{ A}$ $T_{(vj)} = 25^\circ\text{C}$	6.25 V
V_{TO}	$T_{(vj)} = 150^\circ\text{C}$	4.25 V
r_T	$T_{(vj)} = 150^\circ\text{C}$	0.215 mΩ
a	$f = 50\text{Hz}$	5 x 9,81 m/s ²
M_d		8 Nm

Dimensions in mm (1 mm = 0.0394")

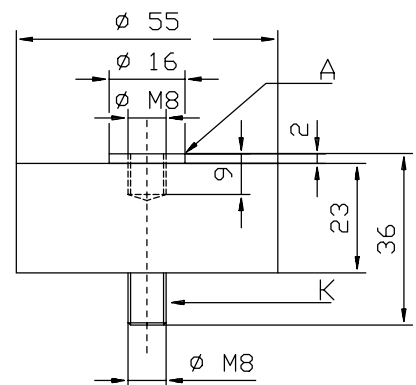

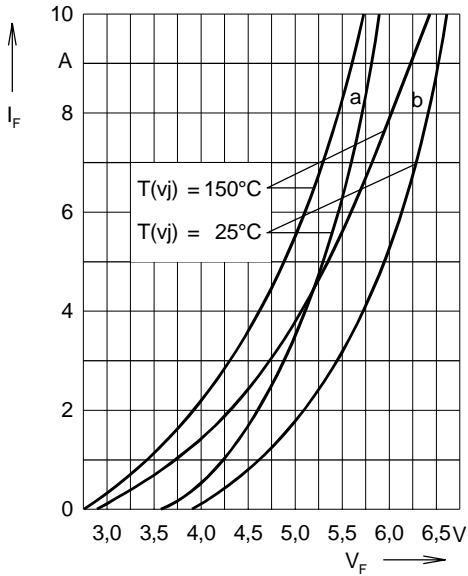

Fig. 1: Forward characteristics
 Instantaneous forward current I_F as a function of instantaneous forward voltage drop V_F for junction temperature $T_{(vj)} = 25^\circ\text{C}$ and $T_{(vj)} = 150^\circ\text{C}$
 a = Mean value characteristic
 b = Limit value characteristic

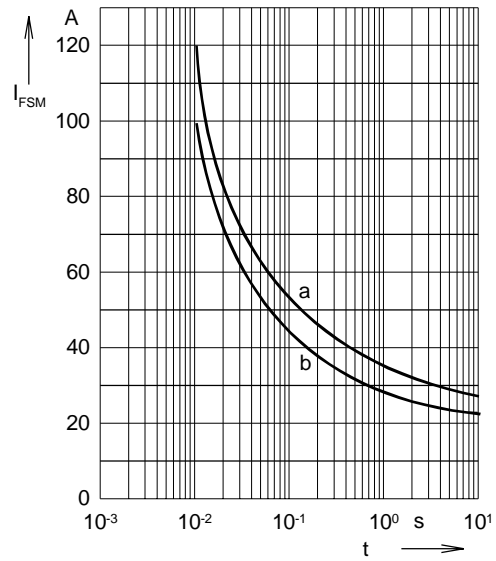

Fig. 2: Characteristics of maximum permissible current
 The curves show the non repetitive peak one cycle surge forward current I_{FSM} as a function of time t and serve for rating protective devices.
 a = Initial state $T_{(vj)} = 45^\circ\text{C}$
 b = Initial state $T_{(vj)} = 150^\circ\text{C}$

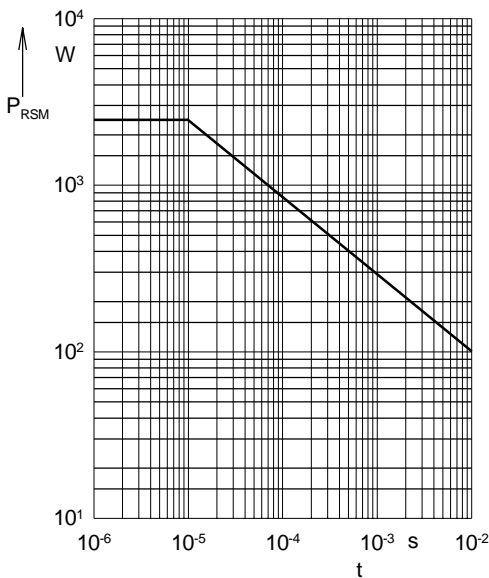

Fig. 3: Power loss
 Non repetitive peak reverse power loss P_{RSM} as a function of time t , $T_{(vj)} = 150^\circ\text{C}$

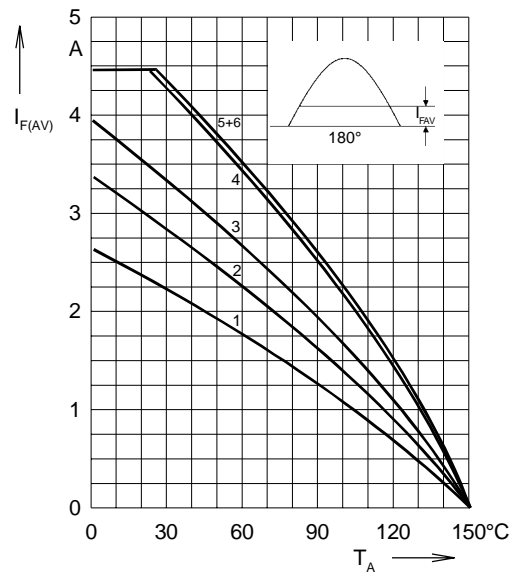

Fig. 4: Load diagramm
 Mean forward current $I_{F(AV)}$ of one module for a sine half wave for various cooling modes as a function of the cooling medium temperature T_{amb} for a resistive load (horizontal mounting).

Cooling modes

- 1 = air self cooling without cooling plate
- 2 = air self cooling with cooling plate
- 3 = forced air cooling without cooling plate
- 4 = forced air cooling with cooling plate
- 5 = oil cooling without cooling plate
- 6 = oil cooling with cooling plate

High Voltage Rectifiers

Hochspannungsgleichrichter

$$V_{RRM} = 24000 \text{ V}$$

$$V_{dT} = 4000 \text{ V}$$

$$I_{F(AV)M} = 2.0 \text{ A}$$

V_{RRM} V	$V_{V(RMS)}$ V	V_{dT} V	Standard Types	Power Designation
24000	9000	4000	UGE 1112 AY4	Si-E 9000 / 4000-0.7

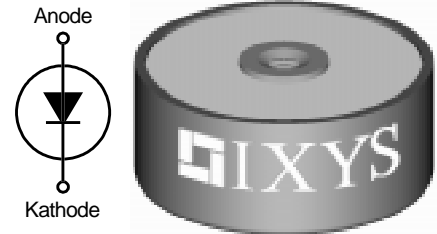

Symbol	Test Conditions	Ratings
$I_{F(RMS)}$ $I_{F(AV)M}$	air self cooling, $T_{amb} = 45^\circ\text{C}$	5 A
	- without cooling plate	0.8 A
	- with colling plate	1.0 A
	forced air cooling: $v = 3 \text{ m/s}$, $T_{amb} = 35^\circ\text{C}$	
	- without cooling plate	1.4 A
	- with cooling plate	1.7 A
	oil cooling, $T_{amb} = 35^\circ\text{C}$	
	- without cooling plate	2.0 A
	- with cooling plate	2.0 A
P_{RSM}	$T_{(vj)} = 150^\circ\text{C}$; $t_p = 10 \mu\text{s}$	1.6 kW
I_{FSM}	non repetitive, 50 c/s (for 60 c/s add 10%) $T_{(vj)} = 45^\circ\text{C}$; $t_p = 10 \text{ ms}$	70 A
	$T_{(vj)} = 150^\circ\text{C}$; $t_p = 10 \text{ ms}$	60 A
T_{amb}		-40...+150 °C
T_{stg}		-40...+150 °C
$T_{(vj)}$		150 °C

Features

- Hermetically sealed Epoxy
- Use in oil
- Avalanche characteristics

Applications

- X-Ray equipment
- Electrostatic dust precipitators
- Electronic beam welding
- Lasers
- Cable test equipment

Advantages

- Simple mounting
- Improved temperature and power cycling
- Reduced protection circuits
- Series and parallel operation

Weight 127 g

Symbol	Test Conditions	Characteristic Values
I_R	$T_{(vj)} = 150^\circ\text{C}$; $V_R = V_{RRM}$	$\leq 1 \text{ mA}$
V_F	$I_F = 3 \text{ A}$ $T_{(vj)} = 25^\circ\text{C}$	18 V
V_{TO}	$T_{(vj)} = 150^\circ\text{C}$	12 V
r_T	$T_{(vj)} = 150^\circ\text{C}$	1.8 mΩ
a	f = 50Hz	5 x 9,81 m/s ²
M_d		8 Nm

Dimensions in mm (1 mm = 0.0394")

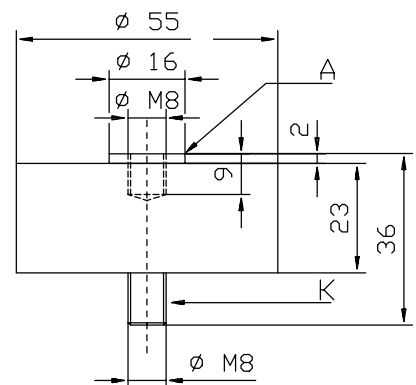

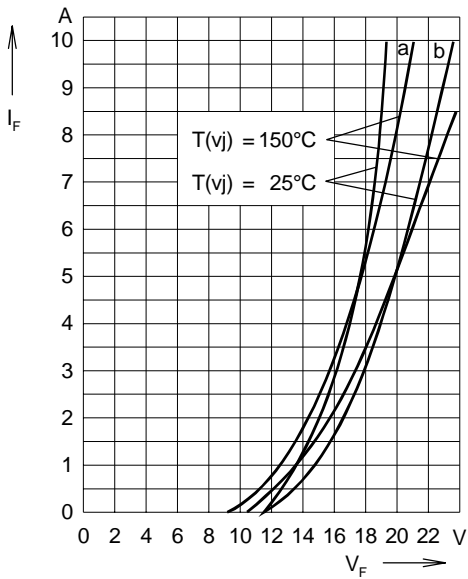

Fig. 1: Forward characteristics

Instantaneous forward current I_F as a function of instantaneous forward voltage drop V_F for junction temperature $T_{(vj)} = 25^\circ\text{C}$ and $T_{(vj)} = 150^\circ\text{C}$
 a = Mean value characteristic
 b = Limit value characteristic

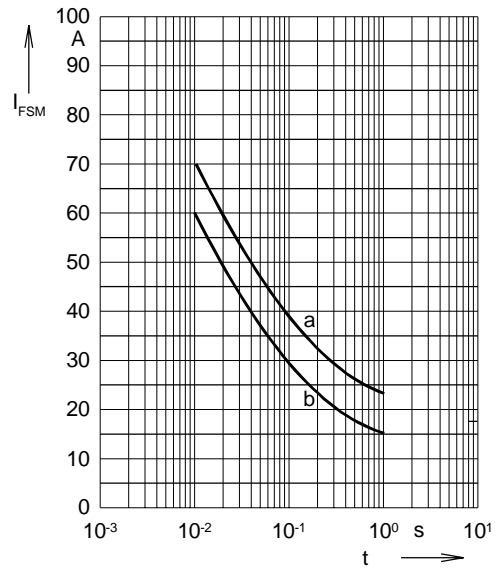

Fig. 2: Characteristics of maximum permissible current

The curves show the non repetitive peak one cycle surge forward current I_{FSM} as a function of time t and serve for rating protective devices.

a = Initial state $T_{(vj)} = 45^\circ\text{C}$
 b = Initial state $T_{(vj)} = 150^\circ\text{C}$

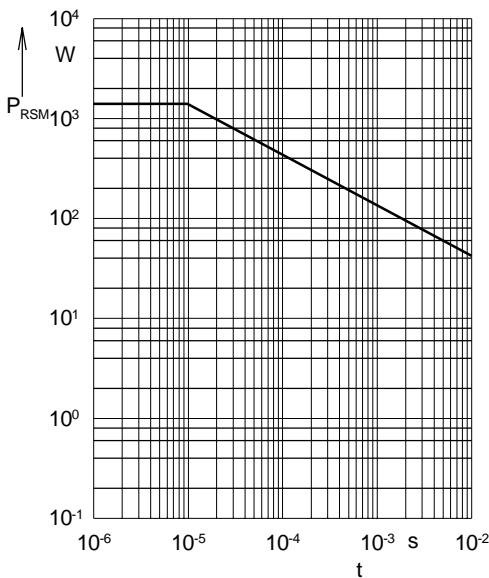

Fig. 3: Power loss

Non repetitive peak reverse power loss P_{RSM} as a function of time t , $T_{(vj)} = 150^\circ\text{C}$

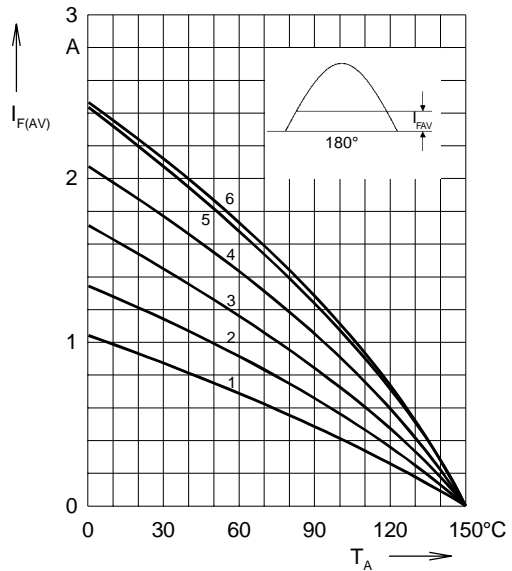

Fig. 4: Load diagramm

Mean forward current $I_{F(AV)}$ of one module for a sine half wave for various cooling modes as a function of the cooling medium temperature T_{amb} for a resistive load (horizontal mounting).

Cooling modes

- 1 = air self cooling without cooling plate
- 2 = air self cooling with cooling plate
- 3 = forced air cooling without cooling plate
- 4 = forced air cooling with cooling plate
- 5 = oil cooling without cooling plate
- 6 = oil cooling with cooling plate

1. General remarks

The high-voltage rectifier modules of the UGE series function as single-leg half-wave rectifiers (abbreviation = E). They are used for high-voltage DC supply, e.g. in

- high frequency generators
- X-ray equipment
- dust precipitators.

The construction of the module plastic case with screw connection simplifies mechanical arrangement of the desired rectifier circuit.

The user's individual input voltage and current requirements can be satisfied by selection of the appropriate modules, by mounting with or without a cooling plate or by series connection of modules.

2. Design

2.1 Electrical

High-voltage rectifier modules consist of an internally integrated series connection of avalanche diodes.

Electric terminals of the module screw connection:

- Anode (A) = Threaded hole
- Cathode (K) = Threaded bolt

2.2 Mechanical

(for dimensions see dimension diagram)

The avalanche diodes are embedded in an epoxy resin pot with axial metal terminals. The materials used guarantee good insulation and resistance to corrosion.

3. Technical data

The operating reliability of high-voltage rectifier modules is mainly influenced by the safety margin between the specified limit values and the operating data. Table on page 3 gives rated voltage values - recommended voltages with a frequency of 40 to 60 Hz and a maximum voltage variation of 10% - for the single leg circuit configuration.

When other rectifier circuits are arranged with these modules V_{dT} becomes:

- bridge circuit, B

$$V_{dT} = 0,9 \times V_{V(RMS)}$$

- three phase bridge circuit, DB

$$V_{dT} = 1,35 = V_{V(RMS)}$$

1. Allgemeines

Die Hochspannungsgleichrichter-Module der Serie UGE sind in ihrer elektrischen Funktion Einweggleichrichter in Einzweigschaltung (Kurzbezeichnung = E). Sie werden zur Hochspannungs-Gleichstromversorgung eingesetzt, z.B. in

- Hochfrequenz-Generatoren
- Röntgenanlagen
- elektrostatischen Staubfilteranlagen.

Die Modulkonstruktion - Kunststoffgehäuse mit Schraubverbindung - ermöglicht einen einfachen mechanischen Aufbau der gewünschten Gleichrichterschaltung.

Anwendungsspezifische Anschlußspannungen und Ströme können durch Auswahl der geeigneten Bausteine, Montage ohne und mit Kühlblech bei verschiedenen Kühlarten oder durch Serienschaltung verwirklicht werden.

2. Aufbau

2.1 Elektrisch

Hochspannungsgleichrichter-Module bestehen aus einer integrierten Reihenschaltung von Avalanche-Dioden.

Elektrische Anschlüsse der Modul-Schraubverbindung:

- Anode (A) = Gewindebohrung
- Kathode (K) = Gewindebolzen.

2.2 Mechanisch

(Abmessungen siehe Maßbild)

In einem Epoxydharzbecher mit axial angeordneten Metallanschlüssen sind die Avalanche-Dioden in Gießharz eingebettet. Die verwendeten Materialien garantieren eine gute Isolationsfähigkeit und Korrosionsbeständigkeit.

3. Technische Daten

Die Betriebszuverlässigkeit von Hochspannungsgleichrichter-Modulen wird wesentlich durch den Sicherheitsabstand zwischen den angegebenen Grenzwerten und den Einsatzdaten beeinflusst. Für die spannungsmäßige Beanspruchung in Einzweigschaltung sind in der Tabelle Seite 3 Nennwerte - das sind empfohlene Betriebsdaten, die für sinusförmige Versorgungsspannung von 40 bis 60 Hz und maximal 10% Spannungsschwankung gelten - angegeben.

Bei Aufbau von anderen Gleichrichterschaltungen mit diesen Modulen ergibt sich V_{dT} entsprechen:

- Brückenschaltung, B

$$V_{dT} = 0,9 \times V_{V(RMS)}$$

- Drehstrom-Brückenschaltung, DB

$$V_{dT} = 1,35 = V_{V(RMS)}$$

4. Current reduction for series connections

When several modules are connected in series (screwed to one another), the allowed mean forward current I_{FAV} should be reduced as a function of the number of modules and cooling mode used.

Cooling modes

1 = Convection cooling	without cooling plate
2 = Convection cooling	with cooling plate
3 = Forced air cooling	without cooling plate
4 = Forced air cooling	with cooling plate
5 = Oil cooling	without cooling plate
6 = Oil cooling	with cooling plate

4. Stromreduktion bei Reihenschaltung

Bei Serienschaltung (Aneinanderschrauben) mehrerer Module ist der zulässige Dauergrenzstrom I_{FAV} in Abhängigkeit von der Anzahl der Module und Kühlart zu reduzieren.

Definition der Kühlarten

1 = Luftselbstkühlung	ohne Kühlblech
2 = Luftselbstkühlung	mit Kühlblech
3 = Verstärkte Luftkühlung	ohne Kühlblech
4 = Verstärkte Luftkühlung	mit Kühlblech
5 = Ölkühlung	ohne Kühlblech
6 = Ölkühlung	mit Kühlblech

Cooling mode Kühlart	Number of modules Anzahl Module					
	2	3	4	5	6	≥ 7
	S_n					
1	0,75	0,65	0,6	0,55	0,5	no further reduction keine weitere Reduktion
2	0,85	0,8	0,78	0,75		
3	0,85	0,8	0,78	0,77		
4	0,95	0,92	0,9	0,88		
5	0,92	0,88	0,86			
6	0,96	0,94				

Table 2: Current reduction factor S_n
Tabelle 2: Stromreduzierungsfaktor S_n

The current reduction factors apply for air self cooling and horizontal mounting (with respect to module axis).

Die Stromreduzierungs-faktoren gelten bei Luftselbstkühlung nur für waagrechte Einbaulage (bezogen auf Modulachse).

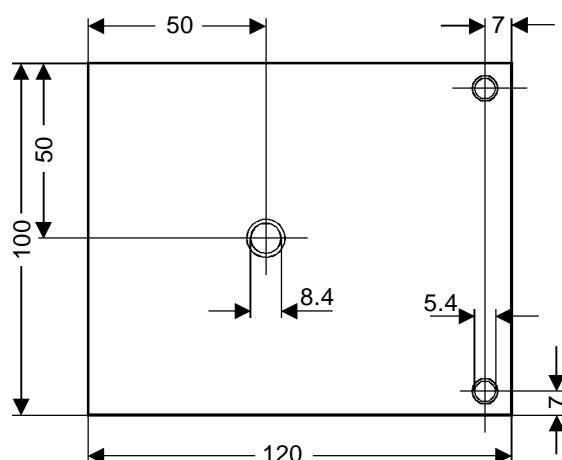

3 mm thick aluminium plate, chamfer all edges.
Aluminium-Blech, 3 mm dick, alle Kanten brechen.

5. Mounting instructions

5.1 Mounting of modules

without cooling plate (Fig. 7):

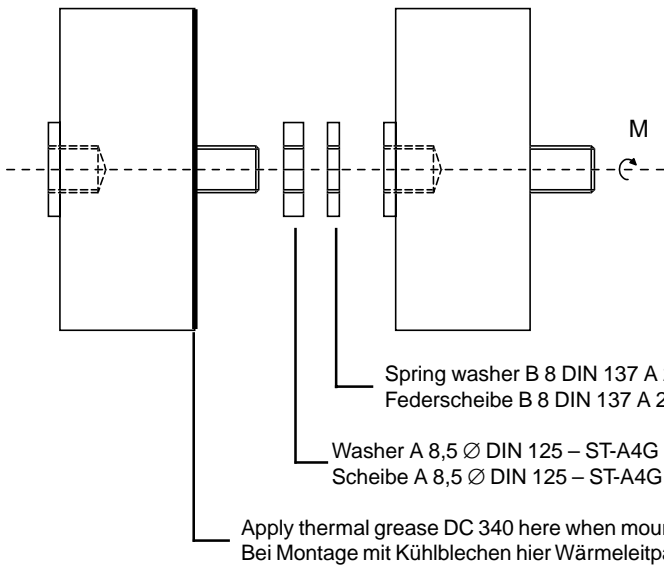

5. Montagehinweise

5.1 Darstellung der Montage:

Montage ohne Kühlblech (Bild 7)

Fig. 7: Mounting of modules
Bild 7: Montage der Module

Torque M = 800 Ncm
Drehmoment M = 800 Ncm

not included in scope of delivery
gehört nicht zum Lieferumfang

5.2 Mounting of modules

with cooling plate:

as shown in Fig. 7, however, the cooling plate is mounted with thermal grease instead of with washer A 8.5 Ø DIN 125.

To satisfy VDE specification 0110, voltage limits are prescribed - depending on the creepage distance of the pot shape (61 mm for mounting without cooling plate, 42 mm for mounting with cooling plate). In case of air cooling care should be taken that the proper class of insulation is chosen for the respective supply voltage (see table 3).

5.2 Montage:

Module mit Kühlblech

wie in Bild 7 skizziert, jedoch anstelle der Scheibe A 8,5 Ø DIN 125 wird das Kühlblech mit Wärmeleitpaste eingesetzt.

Zur Einhaltung der VDE-Vorschrift 0110 sind - bedingt durch den Kriechweg der Bechergeometrie (61 mm bei Montage ohne Kühlblech, 42 mm bei Montage mit Kühlblech) - Spannungsgrenzen vorgeschrieben. Zu beachten ist bei Betrieb in Luft, daß sich die zulässige Anschlußspannung nach der vorgesehenen Isolationsgruppe richtet (siehe Tabelle 3).

Insulation class Isolationsgruppe	A		B		C	
	without Cooling plate ohne Kühlblech	with Cooling plate mit Kühlblech	without Cooling plate ohne Kühlblech	with Cooling plate mit Kühlblech	without Cooling plate ohne Kühlblech	with Cooling plate mit Kühlblech
Construction Aufbauart						
Allowed supply voltage based creepage distance Zulässige Anschlußspannung aufgrund des Kriechwegs	[V] 9000	[V] 7600	[V] 6900	[V] 4900	[V] 5000	[V] 3400

Table 3
Tabelle 3

5.3 Distance to adjacent parts

The distance to adjacent metal parts should be at least 25 mm. This also applies to mounting with cooling plates (see Fig. 8).

A protective circuit in accordance with Table 4 should be provided in order to prevent unpermissible capacitive earth currents from flowing through the first diode. This can be done by arranging the modules in groups for voltages of $V_p \sim 30$ kV each (see Fig. 9).

5.3 Abstände zur Umgebung

Der Abstand zu umgebenden geerdeten Metall-Teilen sollte minimal 25 mm betragen. Dies gilt auch bei Aufbau mit Kühlblechen (siehe Bild 8).

Zur Vermeidung von unzulässigen kapazitiven Erdströmen über die erste Diode ist eine Schutzbeschaltung nach Tabelle 4 vorzusehen. Es sind dabei jeweils Modulgruppen für Teilspannungen von $V_p \sim 30$ kV zu bilden (siehe Bild 9).

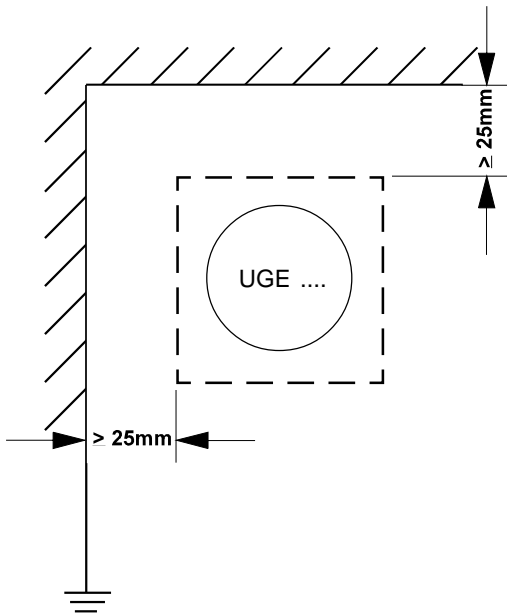

Fig. 8: Minimum distance for mounting
Bild 8: Mindestabstände bei Montage

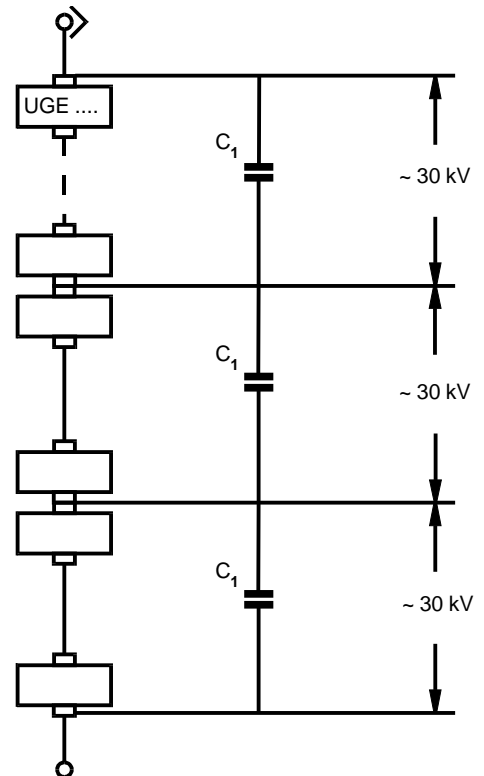

Fig. 9: Circuit for protection of modules against capacitive earth currents
Bild 9: Schutzbeschaltung der Module gegen kapazitive Erdströme

	C_1 (nF)
UGE 0421 AY4	5.6
UGE 0221 AY4	2.2
UGE 1112 AY4	0.87
UGE 3126 AY4	0.15

Table 4: Protective circuit capacitances for avoidance of too high capacitive ground currents from $30 \text{ kV}_{\text{RMS}}$
Tabelle 4: Schutzbeschaltungskapazitäten zur Vermeidung zu großer kapazitiver Erdströme ab $30 \text{ kV}_{\text{RMS}}$

IXYS Semiconductor GmbH
Edisonstr. 15, D-68623 Lampertheim
Telefon: +49-6206-503-0, Fax: +49-6206-503627
e-mail: custserv@ixys.de

IXYS Corporation
3540 Bassett Street, Santa Clara CA 95054
Phone: (408) 982-0700, Fax: 408-496-0670
<http://www.ixys.com>
e-mail: sales@ixys.com

Publication D 97008 DE
Printed in Germany (09.97 • 2 • DP)

Technical advice and further information

IXYS International Sales Representatives

Germany (Reps)

North
Hubert Schroeter KG
Saseler Bogen 1
22393 Hamburg
Phone: 040/6 00 006-0
Fax: 040/6 00 006-30

West
Erhard Mannheim KG
Industrievertretungen
Heidestraße 4
42579 Heiligenhaus
Phone: 02056/9 83 60
Fax: 02056/5 74 37

Southwest
Wolfgang Trautmann
Reutlinger Str. 4
78054 VS-Schwenningen
Phone: 07720/12 03
Fax: 07720/3 34 42

Germany (Distris)

Kluxen GmbH
Nordkanal 52
20097 Hamburg 1
Phone: 040/23 70 15 29
Fax: 040/23 03 85

Dietrich Schuricht
GmbH & Co. KG
Richtweg 32
28195 Bremen
Phone: 0421/36 54 54
Fax: 0421/36 54 291

BETRONIK Handelsgesellschaft
für elektronische Bauelemente mbH
Grünwaldstr. 39a
12165 Berlin
Phone: 030/79 09 97 - 0
Fax: 030/79 09 97 51

Ingenieurbüro
Rainer König
Giesendorfer Str. 11 a
12207 Berlin
Phone: 030/76 89 09 16
Fax: 030/76 89 09 30

MSC Vertriebs GmbH
Industriestraße 16
76297 Stutensee
Phone: 07249/910-0
Fax: 07249/79 93

Future Electronics
Deutschland GmbH
Münchner Straße 18
85774 Unterföhring
Phone: 089/95 72 70
Fax: 089/95 72 71 29

Sparepart-Service
ABB Industrietechnik AG
Geschäftsbereich Service
Edisonstr. 15
68623 Lampertheim
Phone: 06206/503 272
Fax: 06206/503 620

IXYS Semiconductor GmbH
Edisonstr. 15
68623 Lampertheim
Phone: 06206/503 394
Fax: 06206/503 627

Europe

Austria
ABB Serienprodukte Ges.m.b.H.
Abt. SERTQ
Wienerbergstraße 11 B
P.O. Box 184
1101 Wien
Phone: 01-60 10 9-6153
Fax: 01-60 10 9-8600

Denmark
C-88 AS
Kokkedal Industripark 101
2980 Kokkedal
Phone: +45-70 10 48 88
Fax: +45-70 10 48 89

Finland
Energel Oy
Atomitie 1
00370 Helsinki
Phone: 0-586 2066
Fax: 0-586 2046

France
Eurocomposant S.A.
144 Avenue Joseph Kessel
78960 Voisins le Bretonneux
Phone: 1-30 64 95 15
Fax: 1-30 43 68 27

Greece
Markides Michelis & Co
8, Markris Str., Aegaleo
122 41 Athens
Phone: 1-5 98 01 45
Fax: 1-5 90 98 33

Great Britain
IXYS Semiconductor GmbH
Providence House
Forest Road, Binfield
Bracknell,
Berkshire RG 12 5HP
Phone: 01344-48 28 20
Fax: 01344-48 28 10

Great Britain
GD Rectifiers Ltd.
Victoria Gardens
Burgess Hill
West Sussex RH159NB
Phone: 01444-24 34 52
Fax: 01444-87-07-22

Great Britain
Laronrol Ltd.
Unit K4 Brookside Avenue
Rustington Trading Estate
Littlehampton
West Sussex BN16 3LF
Phone: 01903-77 11 60
Fax: 01903-77 20 73

Great Britain
Future Electronics
Poyle Road, Colnbrook
Berkshire SL3 0EZ
Phone: 01753-68 70 00
Fax: 01753-68 91 00

Italy
ABB DACOM SpA
Viale Edison, 50
20099 Sesto San Giovanni (MI)
Phone: 02-26 232.125
Fax: 02-26 232.144

Netherlands
ABB Componenten B.V.
Lylantse Baan 9
2908 LG Capelle a/d IJssel
Phone: 010-2 58 22 50
Fax: 010-4 58 65 59

Norway
Henaco A/S
Trondheimsveien 436
Po. box 126, Kalbakken
0902 Oslo 9
Phone: 2-216 21 10
Fax: 2-225 77 80

Sweden
Pelcon Electronics AB
Girovägen 13
Box 6023
17562 Järfälla
Phone: 8-7 95 98 70
Fax: 8-7 60 76 85

Switzerland
ABB Normelec AG
Badenerstr. 790
8048 Zürich-Altstetten
Phone: 1-4 35 66 66
Fax: 1-4 35 66 06

Spain
ABI Semiconductores
Dalia 387 Ch 6
28109 El Soto (Alcobendas)
Phone: 91-6 50 76 51
Fax: 91-6 50 03 49

Spain
AQL electrónica, s.a.
General Palanca, 26
28045 Madrid
Phone: 91-4 67 75 12
Fax: 91-5 30 29 34

Spain
Rectificadores Guasch S.A.
Componentes y Electronica de
Potencia
Alaba, 60-62
08005 Barcelona
Phone: 93-3 09 88 91
Fax: 93-3 00 18 41

Turkey
Özdisan Elektronik Pazarlama
San. VE TIC. A.S.
Bereketzade Mahallesi
Galata Kulesi Sokak No: 34/3
Karaköy/Istanbul
Phone: 212-243 40 34, 251 29 41
Fax: 212-244 59 43

Asia, Australia, Africa

Australia
Braemac PTY. Ltd.
1/59-61 Burrows Road
Alexandria NSW 2015
Phone: (02) 9550 6600
Fax: (02) 9550 6370

China
KARIN Electronic Supplies
Room 1095, Pana Tower
36 Hai Dian Road
Hai Dian District, Beijing
Phone: 8610-6262 9049
Fax: 8610-6264 8830

China
KARIN Electronic Supplies
Room 305, A Section,
Yin Hai Bldg., 250 Cao Xi Rd.
Shanghai
Phone: 8621-6482 3543
Fax: 8632-6482 3542

China
KARIN Electronic Supplies
Room 1503, Oriental Plaza
39 Janshe Rd, Shenzhen
Phone: 86755-220 9219
Fax: 86755-228 4992

China
Sunguard Electronics Ltd.
Room 112, No. 12B
Zhong Guan Chun Road
Hai Dian District, Beijing
Phone: 10-264-5210,
10-264-5212 + 10-254-2870
Fax: 10-254-2870

China
Sunguard Electronics Ltd.
Room 805, 8/F.,
Sufa Building, Block 306
ZhenHua Road, Shenzhen
Phone: 0755-3230 748 (658)
0755-3237 349
Fax: 0755-3237 394

Hongkong
KARIN Electronic Supplies
Co. Ltd., Div. 8
KARIN Building, 5F
166 Wai Yip St., Kwun Tong
Kowloon, Hong Kong
Phone: 852-2763 3100
Fax: 852-2343 6479

Hongkong
Rével Electronics Co. Ltd.
Unit 11, 12/Floor, Ricky Centre
36 Chong Yip Street, Kwun Tong
Kowloon, Hong Kong
Phone: 23 89-88 91
Fax: 23 89-24 48

Hongkong
Sunguard Electronics Ltd.
907-10 Yat Chau, International Plaza
118 Connaught Road West
Hong Kong
Phone: (852) 2811 8230
Fax: (852) 2960 1239,
2960 1216

India
Chadda Power Semiconductors
501, Savera Apts.
Versova Road, Andheri (West)
Bombay-400 061
Phone: 022-6 26 06 78
Fax: 022-6 31 63 84

Israel
Gallium Electronics Ltd.
11 Hasadna St.
P.O.B. 2552
IL 43650 RA'ANANA
Phone: 972 9 74 82 182
Fax: 972 9 74 84 046

Japan
Unidux Inc.
5-1-21 Kyonan-cho,
Musashino-shi, Tokyo 180
Phone: 0422-32-4500
Fax: 0422-31-2050

Japan
Systems Marketing, Inc.
Fukui Bldg. 2-2-12
Sotokanda, Chiyoda-Ku
Tokyo 101
Phone: 03-32 54 27 51
Fax: 03-32 54 32 88

Japan
Trancy INC
New Heights Aoyama 203
1-1-10 Shibuya,
Shibuya-Ku Tokyo 150
Phone: +81-3-3486-7211
Fax: +81-3-3486-7214

Korea
Asea Brown Boveri Ltd.
Oksan Bldg. 5-9 Fl.
157, Samsung-Dong,
Kangnam-Ku, Seoul 135-090
Phone: 2-52 83 062
Fax: 2-52 83 091

Korea
Kisung International Co. Ltd.
A-7-121, 604-1
Kuro-Dong, Kuro-Ku, Seoul
Phone: 02-679 7348
Fax: 02-675 1404

Korea
Daan Electronic Co., Ltd.
Daan Bldg, 4F
22-1 Singye-Dong,
Yongsan-Ku, Seoul
Phone: 02-822-718-8033
Fax: 02-822-718 1160+1161

Singapore
Practical Electronics Pte. Ltd.
1 Rochor Canal Rd
02-57, Sim Lim Square
Singapore 0718
Phone: 3-38 73 88
Fax: 3-38 16 88

South Africa
ABB Industry (Pty) Ltd. Drives
P.O. Box 11494, Randhart 1457
Phone: 011-8 64 53 40
Fax: 011-9 08 20 61

South Africa
Avnet Kopp (Pty) Ltd
P. O. Box 3853, Rivonia, 2128
South Africa.
Phone: +27 11 444 2333
Fax: +27 11 444 7778

Taiwan
Industrade Co., Ltd.
6F, No. 64, Section 2
Chung Cheng Road
Shihlin, Taipei, Taiwan 111
Phone: 886-2-836 90 11
Fax: 886-2-835 30 37

Sept. 97