

μPD120Nxx Series

R03DS0030EJ0400

Rev.4.00

Apr 15, 2011

THREE-TERMINAL LOW-DROPOUT POSITIVE-VOLTAGE REGULATOR (OUTPUT CURRENT: 0.3 A)

Description

The μPD120Nxx series provides low-voltage output regulators with the output current capacitance of 0.3 A. The output voltage varies according to the product (1.5 V, 1.8 V, 2.5 V, or 3.3 V). The circuit current is low due to the CMOS structure, so the power consumption in the ICs can be reduced. Moreover, since ICs are mounted in the small package of the μPD120Nxx series, this contributes to the miniaturization of the application set.

Features

- Output current: 0.3 A
- On-chip overcurrent protection circuit
- On-chip thermal protection circuit
- Small circuit operation current: 60 μA TYP.

Applications

Digital TV, Audio, HDD, DVD, etc.

Pin Configurations (Marking Side)

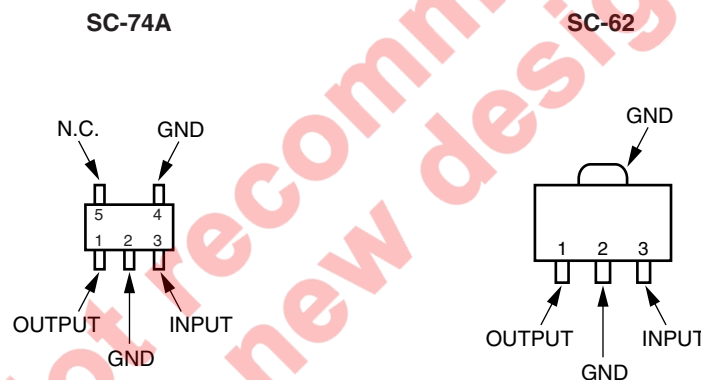

Block Diagram

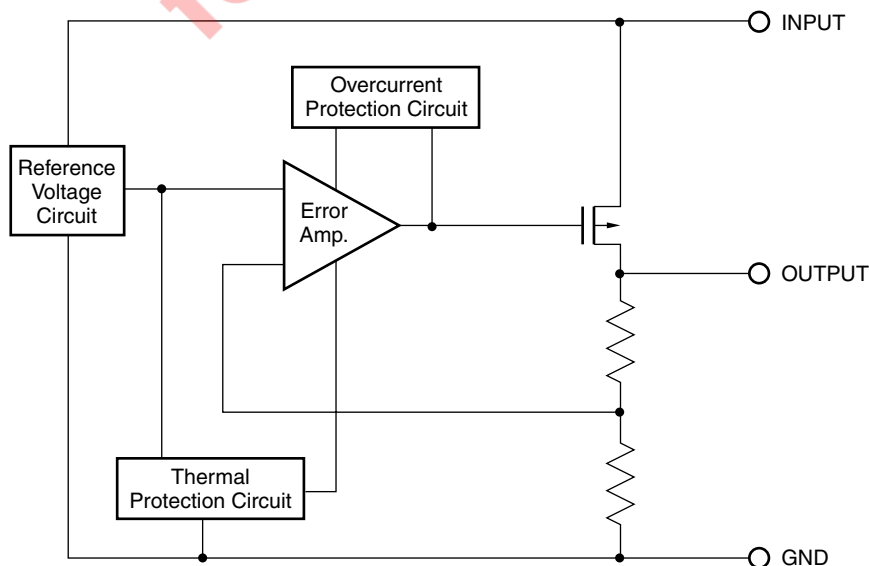

The mark <R> shows major revised points.

The revised points can be easily searched by copying an "<R>" in the PDF file and specifying it in the "Find what:" field.

Ordering Information

Part Number	Package	Output Voltage	Marking
μPD120N15TA	SC-74A	1.5 V	K71
μPD120N15T1B	SC-62	1.5 V	7D
μPD120N18TA	SC-74A	1.8 V	K72
μPD120N18T1B	SC-62	1.8 V	7E
μPD120N25TA	SC-74A	2.5 V	K73
μPD120N25T1B	SC-62	2.5 V	7F
μPD120N33TA	SC-74A	3.3 V	K74
μPD120N33T1B	SC-62	3.3 V	7G

Remark -E1 or -E2 is suffixed to the end of the part number of taping products, and -A, -AT, -AY or -AZ to that of Pb-free products. See the table below for details.

<R>

Part Number ^{Note1}	Package	Package Type
μPD120NxxTA-A ^{Note2}	SC-74A	• Unit
μPD120NxxTA-AT ^{Note2}	SC-74A	• Unit
μPD120NxxTA-E1-A ^{Note2}	SC-74A	<ul style="list-style-type: none"> • 8 mm wide embossed taping • Pin 1 on take-up side • 3000 pcs/reel (MAX.)
μPD120NxxTA-E1-AT ^{Note2}	SC-74A	<ul style="list-style-type: none"> • 8 mm wide embossed taping • Pin 1 on take-up side • 3000 pcs/reel (MAX.)
μPD120NxxTA-E2-A ^{Note2}	SC-74A	<ul style="list-style-type: none"> • 8 mm wide embossed taping • Pin 1 on draw-out side • 3000 pcs/reel (MAX.)
μPD120NxxTA-E2-AT ^{Note2}	SC-74A	<ul style="list-style-type: none"> • 8 mm wide embossed taping • Pin 1 on draw-out side • 3000 pcs/reel (MAX.)
μPD120NxxT1B-AY ^{Note3}	SC-62	• Unit
μPD120NxxT1B-AZ ^{Note3}	SC-62	• Unit
μPD120NxxT1B-E1-AY ^{Note3}	SC-62	<ul style="list-style-type: none"> • 12 mm wide embossed taping • Pin 1 on take-up side • 1000 pcs/reel (MAX.)
μPD120NxxT1B-E1-AZ ^{Note3}	SC-62	<ul style="list-style-type: none"> • 12 mm wide embossed taping • Pin 1 on take-up side • 1000 pcs/reel (MAX.)
μPD120NxxT1B-E2-AY ^{Note3}	SC-62	<ul style="list-style-type: none"> • 12 mm wide embossed taping • Pin 1 on draw-out side • 1000 pcs/reel (MAX.)
μPD120NxxT1B-E2-AZ ^{Note3}	SC-62	<ul style="list-style-type: none"> • 12 mm wide embossed taping • Pin 1 on draw-out side • 1000 pcs/reel (MAX.)

Notes 1. xx stands for symbols that indicate the output voltage.

2. Pb-free (This product does not contain Pb in external electrode and other parts.)
3. Pb-free (This product does not contain Pb in external electrode.)

Absolute Maximum Ratings (TA = 25°C, unless otherwise specified.)

Parameter	Symbol	Rating		Unit
		μPD120NxxTA	μPD120NxxT1B	
Input Voltage	V _{IN}	-0.3 to +6		V
Power Dissipation ^{Note1}	P _T	180/510 ^{Note2}	400/2000 ^{Note3}	mW
Operating Ambient Temperature	T _A	-40 to +85		°C
Operating Junction Temperature	T _J	-40 to +150		°C
Storage Temperature	T _{stg}	-55 to +150		°C
Thermal Resistance (junction to ambient)	R _{th(J-A)}	695/245 ^{Note2}	315/62.5 ^{Note3}	°C/W

Note 1. Internally limited. When the operating junction temperature rises over 150°C, the internal circuit shuts down the output voltage.

- 2. Mounted on ceramic substrate of 75 mm² x 0.7 mm
- 3. Mounted on ceramic substrate of 16 cm² x 0.7 mm

Caution Product quality may suffer if the absolute maximum rating is exceeded even momentarily for any parameter. That is, the absolute maximum ratings are rated values at which the product is on the verge of suffering physical damage, and therefore the product must be used under conditions that ensure that the absolute maximum ratings are not exceeded.

Typical Connection

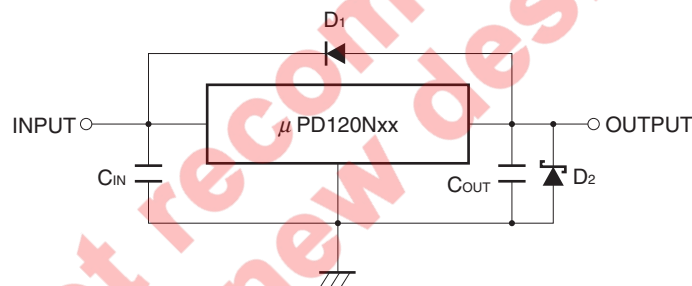

C_{IN}: 0.1 μF or higher. Set this value according to the length of the line between the regulator and INPUT pin. Be sure to connect C_{IN} to prevent parasitic oscillation. If using a laminated ceramic capacitor, it is necessary to ensure that C_{IN} is 0.1 μF or higher for the voltage and temperature range to be used.

C_{OUT}: 10 μF or higher. Be sure to connect C_{OUT} to prevent oscillation and improve excessive load regulation. Place C_{IN} and C_{OUT} as close as possible to the IC pins (within 2 cm). Be sure to use the capacitor of 10 μF or higher of capacity values and 1 to 8 Ω of equivalent series resistance under an operating condition.

D1: If the OUTPUT pin has a higher voltage than the INPUT pin, connect a diode.

D2: If the OUTPUT pin has a lower voltage than the GND pin, connect a schottky barrier diode.

Caution Make sure that no voltage is applied to the OUTPUT pin from external.

Recommended Operating Conditions

Parameter	Symbol	Type Number	MIN.	TYP.	MAX.	Unit
Input Voltage	V _{IN}	μPD120N15	3.0		5.5	V
		μPD120N18	3.2		5.5	V
		μPD120N25	4.5		5.5	V
		μPD120N33	4.5		5.5	V
Output Current	I _O	All	0		0.3	A
Operating Ambient Temperature	T _A	All	-40		+85	°C
Operating Junction Temperature	T _J	All	-40		+125	°C

Caution Use of conditions other than the above-listed recommended operating conditions is not a problem as long as the absolute maximum ratings are not exceeded. However, since the use of such conditions diminishes the margin of safety, careful evaluation is required before such conditions are used. Moreover, using the MAX. value for all the recommended operating conditions is not guaranteed to be safe.

Electrical Characteristics

μPD120N15 (T_J = 25°C, V_{IN} = 5.0 V, I_O = 0.15 A, C_{IN} = 0.1 μF, C_{OUT} = 10 μF, unless otherwise specified.)

<R>

Parameter	Symbol	Conditions	MIN.	TYP.	MAX.	Unit
Output Voltage	V _{O1}		1.47	1.5	1.53	V
	V _{O2}	3.0 V ≤ V _{IN} ≤ 5.5 V, 0 A ≤ I _O ≤ 0.3 A	1.455	–	1.545	V
Line Regulation	REG _{IN}	3.0 V ≤ V _{IN} ≤ 5.5 V	–	1	30	mV
Load Regulation	REG _L	0 A ≤ I _O ≤ 0.3 A	–	2	30	mV
Quiescent Current	I _{BIAS}	I _O = 0 A	–	60	120	μA
Quiescent Current Change	ΔI _{BIAS}	3.0 V ≤ V _{IN} ≤ 5.5 V	–	–	25	μA
Output Noise Voltage	V _n	10 Hz ≤ f ≤ 100 kHz	–	100	–	μV _{r.m.s.}
Ripple Rejection	R•R	f = 1 kHz, 3.0 V ≤ V _{IN} ≤ 5.5 V	–	63	–	dB
Dropout Voltage	V _{DIF}	I _O = 0.15 A	–	0.6	0.9	V
		I _O = 0.3 A	–	1.0	–	V
Short Circuit Current	I _{short}	V _{IN} = 5 V	–	0.2	–	A
Peak Output Current	I _{peak}	V _{IN} = 5 V	0.3	–	–	A
Temperature Coefficient of Output Voltage	ΔV _O /ΔT	I _O = 0 A, 0°C ≤ T _J ≤ 125°C	–	-0.03	–	mV/°C

μPD120N18 (T_J = 25°C, V_{IN} = 5.0 V, I_O = 0.15 A, C_{IN} = 0.1 μF, C_{OUT} = 10 μF, unless otherwise specified.)

<R>

Parameter	Symbol	Conditions	MIN.	TYP.	MAX.	Unit
Output Voltage	V _{O1}		1.764	1.8	1.836	V
	V _{O2}	3.2 V ≤ V _{IN} ≤ 5.5 V, 0 A ≤ I _O ≤ 0.3 A	1.746	–	1.854	V
Line Regulation	REG _{IN}	3.2 V ≤ V _{IN} ≤ 5.5 V	–	1	30	mV
Load Regulation	REG _L	0 A ≤ I _O ≤ 0.3 A	–	2	30	mV
Quiescent Current	I _{BIAS}	I _O = 0 A	–	60	120	μA
Quiescent Current Change	ΔI _{BIAS}	3.2 V ≤ V _{IN} ≤ 5.5 V	–	–	25	μA
Output Noise Voltage	V _n	10 Hz ≤ f ≤ 100 kHz	–	120	–	μV _{r.m.s.}
Ripple Rejection	R•R	f = 1 kHz, 3.2 V ≤ V _{IN} ≤ 5.5 V	–	63	–	dB
Dropout Voltage	V _{DIF}	I _O = 0.15 A	–	0.4	0.65	V
Short Circuit Current	I _{short}	V _{IN} = 5 V	–	0.2	–	A
Peak Output Current	I _{peak}	V _{IN} = 5 V	0.3	–	–	A
Temperature Coefficient of Output Voltage	ΔV _O /ΔT	I _O = 0 A, 0°C ≤ T _J ≤ 125°C	–	-0.06	–	mV/°C

μPD120N25 (T_J = 25°C, V_{IN} = 5.0 V, I_o = 0.15 A, C_{IN} = 0.1 μF, C_{OUT} = 10 μF, unless otherwise specified.)

<R>

Parameter	Symbol	Conditions	MIN.	TYP.	MAX.	Unit
Output Voltage	V _{O1}		2.45	2.5	2.55	V
	V _{O2}	4.5 V ≤ V _{IN} ≤ 5.5 V, 0 A ≤ I _o ≤ 0.3 A	2.425	–	2.575	V
Line Regulation	REG _{IN}	4.5 V ≤ V _{IN} ≤ 5.5 V	–	1	30	mV
Load Regulation	REG _L	0 A ≤ I _o ≤ 0.3 A	–	2	30	mV
Quiescent Current	I _{BIAS}	I _o = 0 A	–	60	120	μA
Quiescent Current Change	ΔI _{BIAS}	4.5 V ≤ V _{IN} ≤ 5.5 V	–	–	25	μA
Output Noise Voltage	V _n	10 Hz ≤ f ≤ 100 kHz	–	170	–	μV _{r.m.s.}
Ripple Rejection	R•R	f = 1 kHz, 4.5 V ≤ V _{IN} ≤ 5.5 V	–	60	–	dB
Dropout Voltage	V _{DIF}	I _o = 0.15 A	–	0.3	0.7	V
Short Circuit Current	I _{short}	V _{IN} = 5 V	–	0.2	–	A
Peak Output Current	I _{opeak}	V _{IN} = 5 V	0.3	–	–	A
Temperature Coefficient of Output Voltage	ΔV _o /ΔT	I _o = 0 A, 0°C ≤ T _J ≤ 125°C	–	–0.07	–	mV/°C

μPD120N33 (T_J = 25°C, V_{IN} = 5.0 V, I_o = 0.15 A, C_{IN} = 0.1 μF, C_{OUT} = 10 μF, unless otherwise specified.)

<R>

Parameter	Symbol	Conditions	MIN.	TYP.	MAX.	Unit
Output Voltage	V _{O1}		3.234	3.3	3.366	V
	V _{O2}	4.5 V ≤ V _{IN} ≤ 5.5 V, 0 A ≤ I _o ≤ 0.3 A	3.201	–	3.399	V
Line Regulation	REG _{IN}	4.5 V ≤ V _{IN} ≤ 5.5 V	–	1	30	mV
Load Regulation	REG _L	0 A ≤ I _o ≤ 0.3 A	–	2	30	mV
Quiescent Current	I _{BIAS}	I _o = 0 A	–	60	120	μA
Quiescent Current Change	ΔI _{BIAS}	4.5 V ≤ V _{IN} ≤ 5.5 V	–	–	25	μA
Output Noise Voltage	V _n	10 Hz ≤ f ≤ 100 kHz	–	220	–	μV _{r.m.s.}
Ripple Rejection	R•R	f = 1 kHz, 4.5 V ≤ V _{IN} ≤ 5.5 V	–	60	–	dB
Dropout Voltage	V _{DIF}	I _o = 0.15 A	–	0.2	0.6	V
Short Circuit Current	I _{short}	V _{IN} = 5 V	–	0.2	–	A
Peak Output Current	I _{opeak}	V _{IN} = 5 V	0.3	–	–	A
Temperature Coefficient of Output Voltage	ΔV _o /ΔT	I _o = 0 A, 0°C ≤ T _J ≤ 125°C	–	–0.06	–	mV/°C

Typical Characteristics

P_d vs. T_A (μPD120NxxTA)

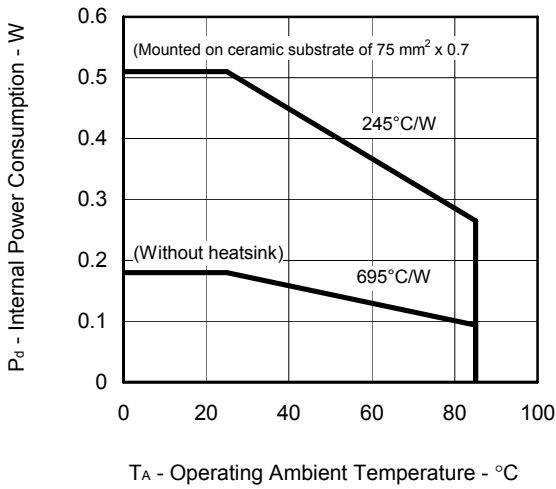

P_d vs. T_A (μPD120NxxT1B)

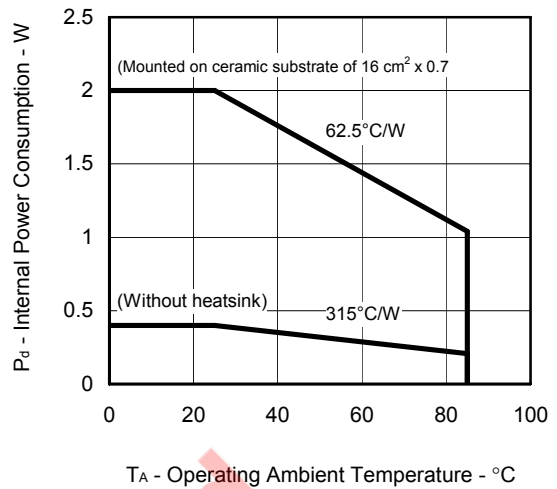

ΔV_o vs. T_J

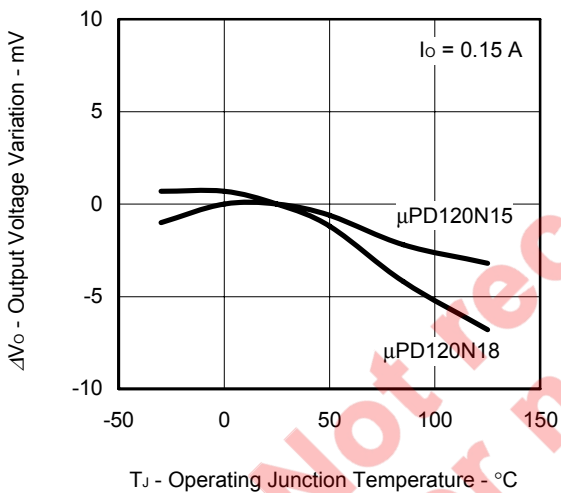

ΔV_o vs. T_J

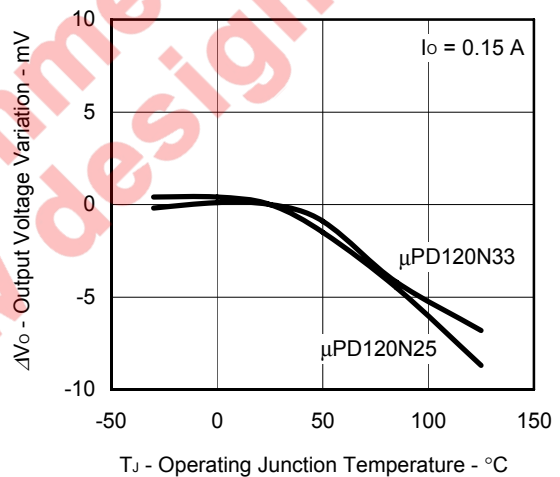

V_o vs. V_{IN} (μPD120N15)

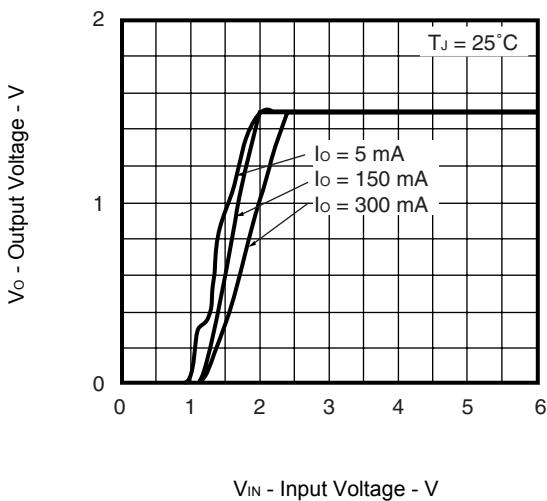

V_o vs. V_{IN} (μPD120N18)

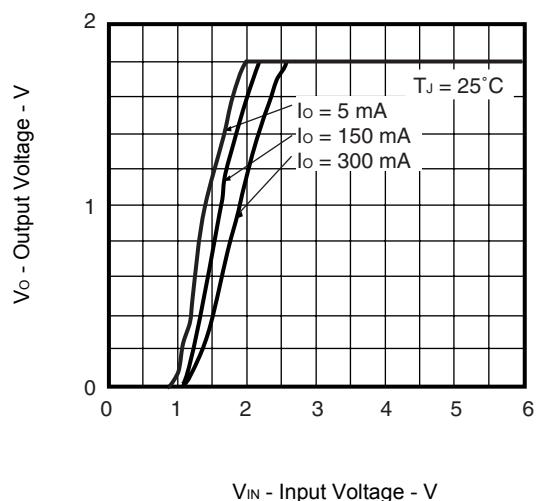

V_O vs. V_{IN} (μPD120N25)

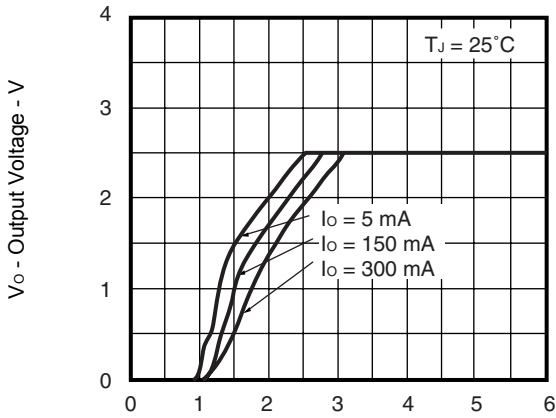

V_{IN} - Input Voltage - V

V_O vs. V_{IN} (μPD120N33)

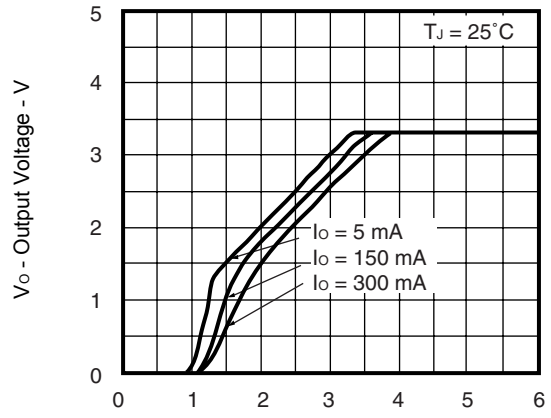

V_{IN} - Input Voltage - V

I_{BIAS} ($I_{BIAS(S)}$) vs. V_{IN} (μPD120N15)

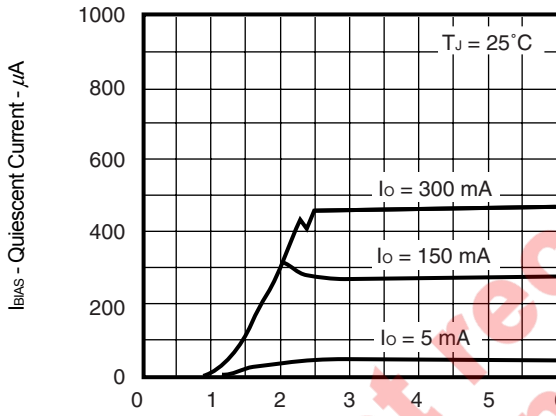

V_{IN} - Input Voltage - V

I_{BIAS} ($I_{BIAS(S)}$) vs. V_{IN} (μPD120N18)

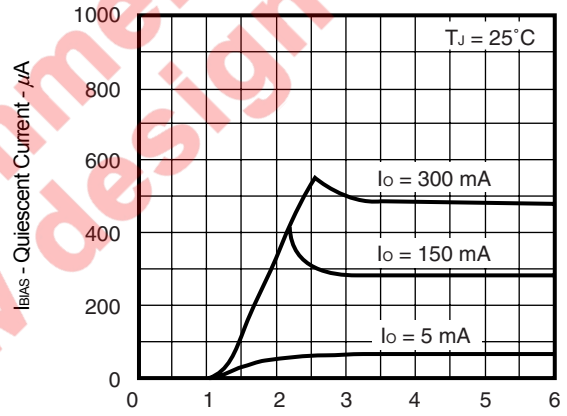

V_{IN} - Input Voltage - V

I_{BIAS} ($I_{BIAS(S)}$) vs. V_{IN} (μPD120N25)

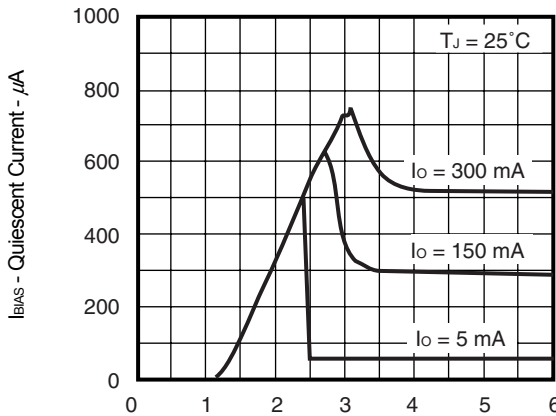

V_{IN} - Input Voltage - V

I_{BIAS} ($I_{BIAS(S)}$) vs. V_{IN} (μPD120N33)

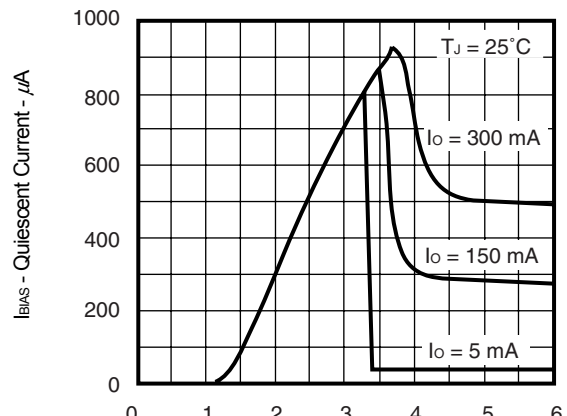

V_{IN} - Input Voltage - V

V_{DIF} vs. T_J

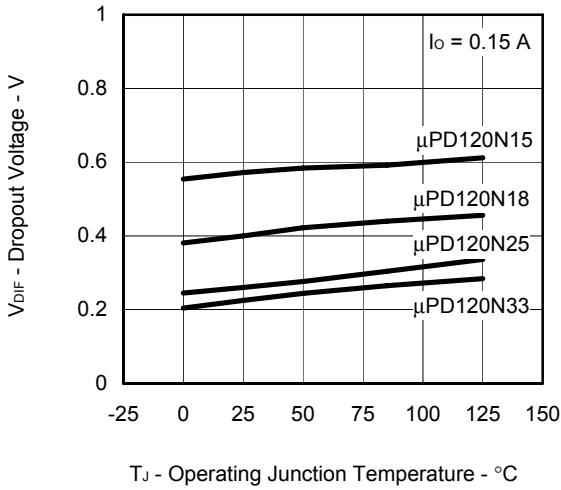

I_{opeak} vs. V_{DIF} (μPD120N15)

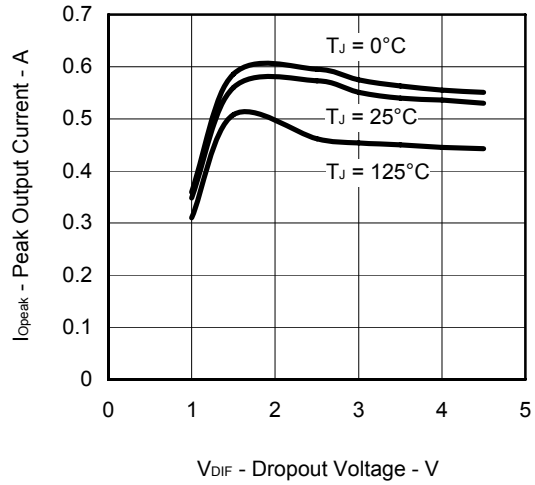

I_{opeak} vs. V_{DIF} (μPD120N18)

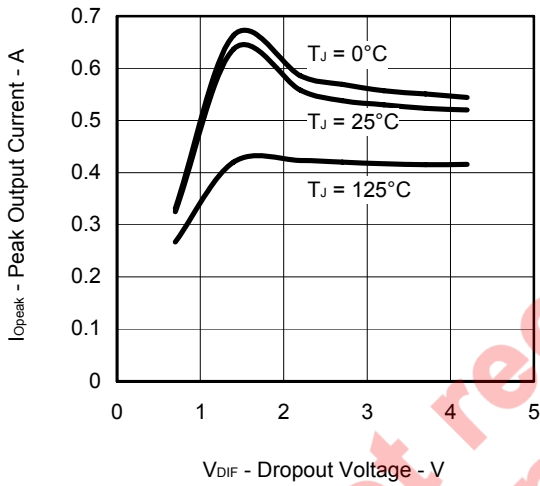

I_{opeak} vs. V_{DIF} (μPD120N25)

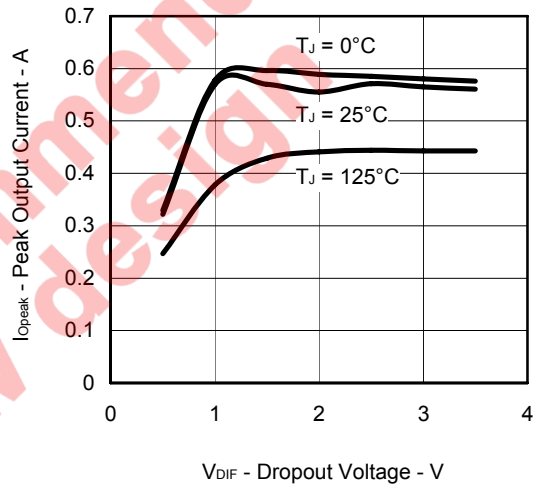

I_{opeak} vs. V_{DIF} (μPD120N33)

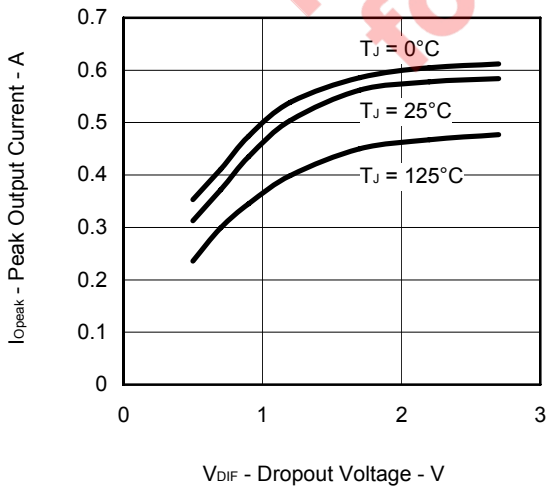

R•R vs. f

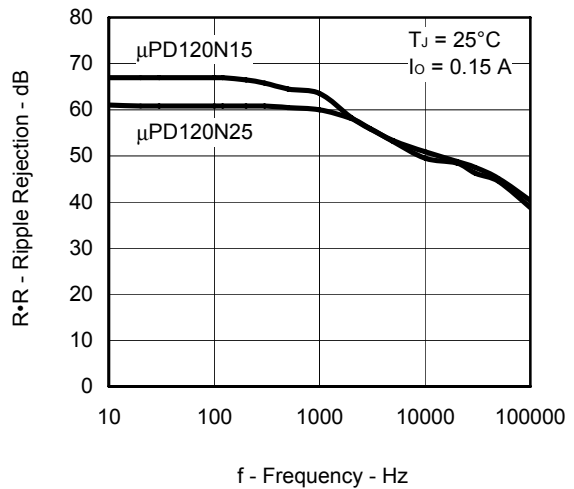

R•R vs. f

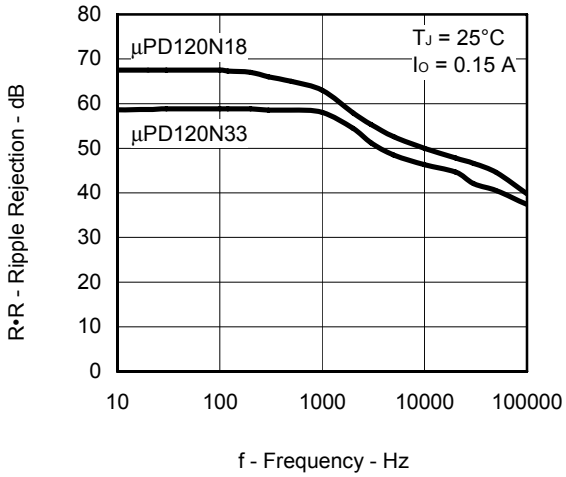

V_{DIF} vs. I_o

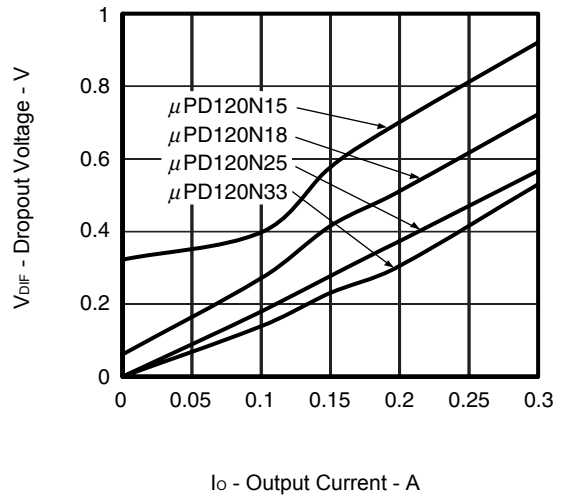

V_o vs. I_o (μPD120N15)

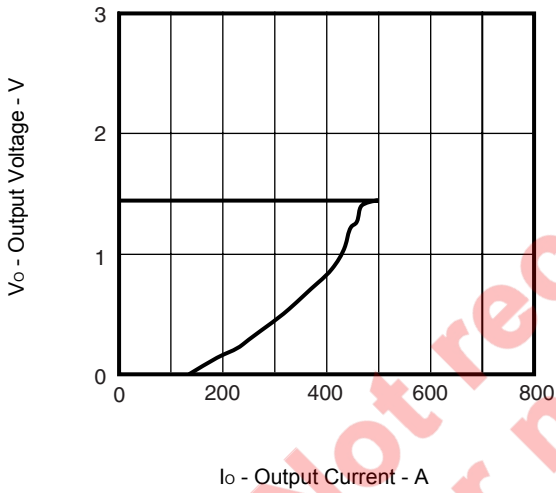

V_o vs. I_o (μPD120N18)

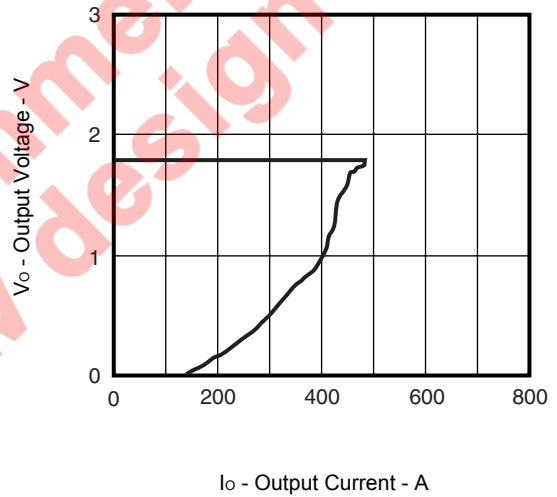

V_o vs. I_o (μPD120N25)

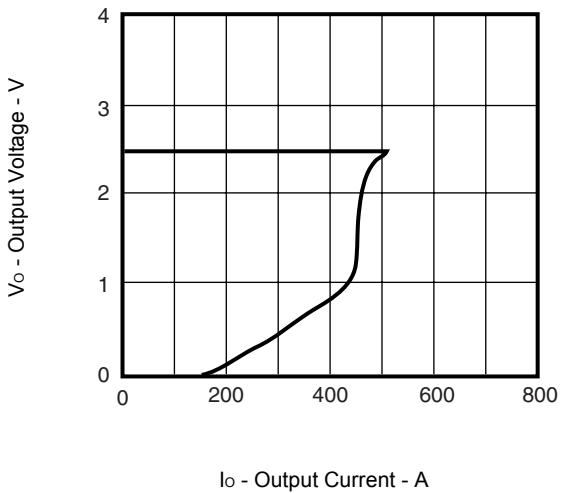

V_o vs. I_o (μPD120N33)

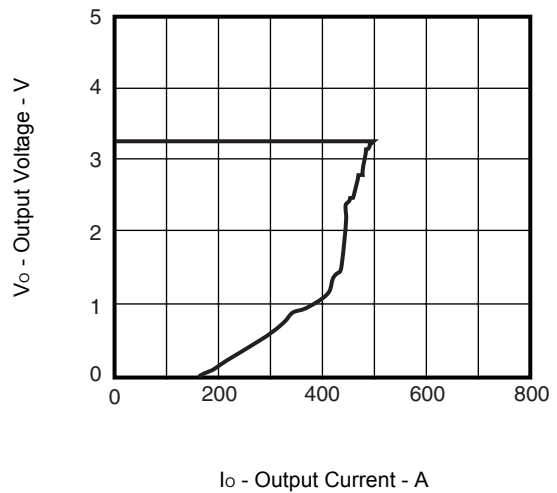

Package Drawings (Unit: mm)

SC-74A

5 PIN PLASTIC MINI MOLD

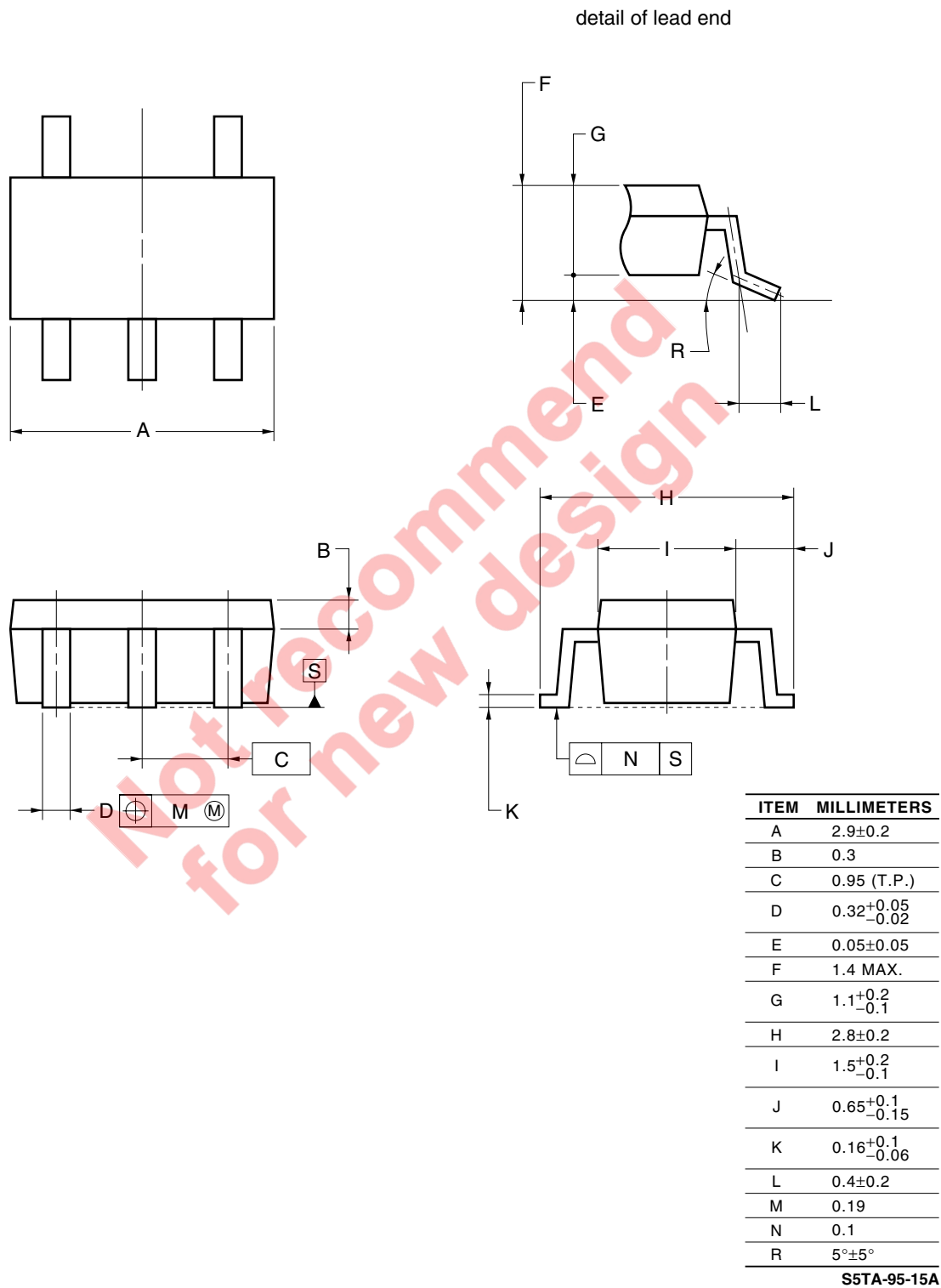

SC-62

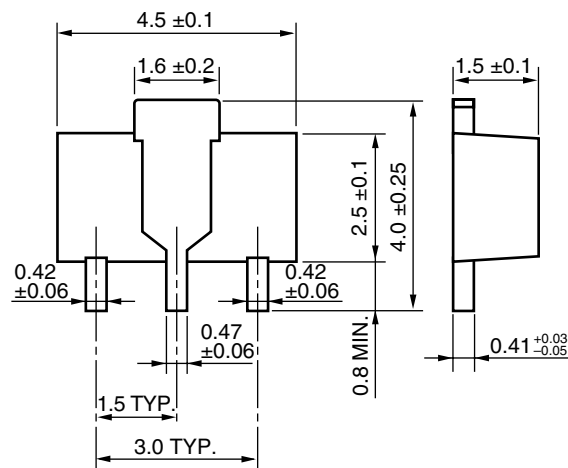

Not recommend
for new design

<R> **Recommended Soldering Conditions**

The μPD120Nxx series should be soldered and mounted under the following recommended conditions.

For soldering methods and conditions other than those recommended below, contact a Renesas Electronics sales representative.

For technical information, see the following website.

Semiconductor Device Mount Manual (<http://www.renesas.com/prod/package/manual/>)

Surface Mount Device

μPD120N15TA-A, μPD120N18TA-A, μPD120N25TA-A, μPD120N33TA-A: SC-74A ^{Note1}
μPD120N15TA-AT, μPD120N18TA-AT, μPD120N25TA-AT, μPD120N33TA-AT: SC-74A ^{Note1}
μPD120N15T1B-AY, μPD120N18T1B-AY, μPD120N25T1B-AY, μPD120N33T1B-AY: SC-62 ^{Note2}
μPD120N15T1B-AZ, μPD120N18T1B-AZ, μPD120N25T1B-AZ, μPD120N33T1B-AZ: SC-62 ^{Note2}

Process	Conditions	Symbol
Infrared Ray Reflow	Peak temperature: 260°C or below (Package surface temperature), Reflow time: 60 seconds or less (at 220°C or higher), Maximum number of reflows processes: 3 times or less.	IR60-00-3
Partial Heating Method	Pin temperature: 350°C or below, Heat time: 3 seconds or less (Per each side of the device).	P350

Notes 1. Pb-free (This product does not contain Pb in external electrode and other parts.)

2. Pb-free (This product does not contain Pb in external electrode.)

Caution Do not use different soldering methods together (except for partial heating).

Remark Flux: Rosin-based flux with low chlorine content (chlorine 0.2 Wt% or below) is recommended.

Reference Documents

USER'S MANUAL USAGE OF THREE TERMINAL REGULATORS Document No.G12702E ^{Note}
INFORMATION VOLTAGE REGULATOR OF SMD Document No.G11872E ^{Note}
SEMICONDUCTOR PACKAGE MOUNT MANUAL

<http://www.renesas.com/prod/package/index.html>

Note Published by the former NEC Electronics Corporation.

NOTES FOR CMOS DEVICES

- (1) VOLTAGE APPLICATION WAVEFORM AT INPUT PIN: Waveform distortion due to input noise or a reflected wave may cause malfunction. If the input of the CMOS device stays in the area between VIL (MAX) and VIH (MIN) due to noise, etc., the device may malfunction. Take care to prevent chattering noise from entering the device when the input level is fixed, and also in the transition period when the input level passes through the area between VIL (MAX) and VIH (MIN).
- (2) HANDLING OF UNUSED INPUT PINS: Unconnected CMOS device inputs can be cause of malfunction. If an input pin is unconnected, it is possible that an internal input level may be generated due to noise, etc., causing malfunction. CMOS devices behave differently than Bipolar or NMOS devices. Input levels of CMOS devices must be fixed high or low by using pull-up or pull-down circuitry. Each unused pin should be connected to VDD or GND via a resistor if there is a possibility that it will be an output pin. All handling related to unused pins must be judged separately for each device and according to related specifications governing the device.
- (3) PRECAUTION AGAINST ESD: A strong electric field, when exposed to a MOS device, can cause destruction of the gate oxide and ultimately degrade the device operation. Steps must be taken to stop generation of static electricity as much as possible, and quickly dissipate it when it has occurred. Environmental control must be adequate. When it is dry, a humidifier should be used. It is recommended to avoid using insulators that easily build up static electricity. Semiconductor devices must be stored and transported in an anti-static container, static shielding bag or conductive material. All test and measurement tools including work benches and floors should be grounded. The operator should be grounded using a wrist strap. Semiconductor devices must not be touched with bare hands. Similar precautions need to be taken for PW boards with mounted semiconductor devices.
- (4) STATUS BEFORE INITIALIZATION: Power-on does not necessarily define the initial status of a MOS device. Immediately after the power source is turned ON, devices with reset functions have not yet been initialized. Hence, power-on does not guarantee output pin levels, I/O settings or contents of registers. A device is not initialized until the reset signal is received. A reset operation must be executed immediately after power-on for devices with reset functions.
- (5) POWER ON/OFF SEQUENCE: In the case of a device that uses different power supplies for the internal operation and external interface, as a rule, switch on the external power supply after switching on the internal power supply. When switching the power supply off, as a rule, switch off the external power supply and then the internal power supply. Use of the reverse power on/off sequences may result in the application of an overvoltage to the internal elements of the device, causing malfunction and degradation of internal elements due to the passage of an abnormal current. The correct power on/off sequence must be judged separately for each device and according to related specifications governing the device.
- (6) INPUT OF SIGNAL DURING POWER OFF STATE : Do not input signals or an I/O pull-up power supply while the device is not powered. The current injection that results from input of such a signal or I/O pull-up power supply may cause malfunction and the abnormal current that passes in the device at this time may cause degradation of internal elements. Input of signals during the power off state must be judged separately for each device and according to related specifications governing the device.

Revision History	μ PD120Nxx Series Data Sheet
------------------	----------------------------------

Rev.	Date	Description	
		Page	Summary
-	Jun 2007	-	Previous No. : S17145EJ3V0DS00
4.00	Apr 15, 2011	Throughout	Addition of Pb-free products (-AT, -AY)
		pp.4, 5	Modification of Absolute Maximum Ratings Output Noise Voltage $10\text{ kHz} \leq f \leq 100\text{ kHz} \rightarrow 10\text{ Hz} \leq f \leq 100\text{ kHz}$

Not recommend
for new design

Notice

- All information included in this document is current as of the date this document is issued. Such information, however, is subject to change without any prior notice. Before purchasing or using any Renesas Electronics products listed herein, please confirm the latest product information with a Renesas Electronics sales office. Also, please pay regular and careful attention to additional and different information to be disclosed by Renesas Electronics such as that disclosed through our website.
- Renesas Electronics does not assume any liability for infringement of patents, copyrights, or other intellectual property rights of third parties by or arising from the use of Renesas Electronics products or technical information described in this document. No license, express, implied or otherwise, is granted hereby under any patents, copyrights or other intellectual property rights of Renesas Electronics or others.
- You should not alter, modify, copy, or otherwise misappropriate any Renesas Electronics product, whether in whole or in part.
- Descriptions of circuits, software and other related information in this document are provided only to illustrate the operation of semiconductor products and application examples. You are fully responsible for the incorporation of these circuits, software, and information in the design of your equipment. Renesas Electronics assumes no responsibility for any losses incurred by you or third parties arising from the use of these circuits, software, or information.
- When exporting the products or technology described in this document, you should comply with the applicable export control laws and regulations and follow the procedures required by such laws and regulations. You should not use Renesas Electronics products or the technology described in this document for any purpose relating to military applications or use by the military, including but not limited to the development of weapons of mass destruction. Renesas Electronics products and technology may not be used for or incorporated into any products or systems whose manufacture, use, or sale is prohibited under any applicable domestic or foreign laws or regulations.
- Renesas Electronics has used reasonable care in preparing the information included in this document, but Renesas Electronics does not warrant that such information is error free. Renesas Electronics assumes no liability whatsoever for any damages incurred by you resulting from errors in or omissions from the information included herein.
- Renesas Electronics products are classified according to the following three quality grades: "Standard", "High Quality", and "Specific". The recommended applications for each Renesas Electronics product depends on the product's quality grade, as indicated below. You must check the quality grade of each Renesas Electronics product before using it in a particular application. You may not use any Renesas Electronics product for any application categorized as "Specific" without the prior written consent of Renesas Electronics. Further, you may not use any Renesas Electronics product for any application for which it is not intended without the prior written consent of Renesas Electronics. Renesas Electronics shall not be in any way liable for any damages or losses incurred by you or third parties arising from the use of any Renesas Electronics product for an application categorized as "Specific" or for which the product is not intended where you have failed to obtain the prior written consent of Renesas Electronics. The quality grade of each Renesas Electronics product is "Standard" unless otherwise expressly specified in a Renesas Electronics data sheets or data books, etc.
Standard: Computers; office equipment; communications equipment; test and measurement equipment; audio and visual equipment; home electronic appliances; machine tools; personal electronic equipment; and industrial robots.
High Quality: Transportation equipment (automobiles, trains, ships, etc.); traffic control systems; anti-disaster systems; anti-crime systems; safety equipment; and medical equipment not specifically designed for life support.
Specific: Aircraft; aerospace equipment; submersible repeaters; nuclear reactor control systems; medical equipment or systems for life support (e.g. artificial life support devices or systems), surgical implantations, or healthcare intervention (e.g. excision, etc.), and any other applications or purposes that pose a direct threat to human life.
- You should use the Renesas Electronics products described in this document within the range specified by Renesas Electronics, especially with respect to the maximum rating, operating supply voltage range, movement power voltage range, heat radiation characteristics, installation and other product characteristics. Renesas Electronics shall have no liability for malfunctions or damages arising out of the use of Renesas Electronics products beyond such specified ranges.
- Although Renesas Electronics endeavors to improve the quality and reliability of its products, semiconductor products have specific characteristics such as the occurrence of failure at a certain rate and malfunctions under certain use conditions. Further, Renesas Electronics products are not subject to radiation resistance design. Please be sure to implement safety measures to guard them against the possibility of physical injury, and injury or damage caused by fire in the event of the failure of a Renesas Electronics product, such as safety design for hardware and software including but not limited to redundancy, fire control and malfunction prevention, appropriate treatment for aging degradation or any other appropriate measures. Because the evaluation of microcomputer software alone is very difficult, please evaluate the safety of the final products or system manufactured by you.
- Please contact a Renesas Electronics sales office for details as to environmental matters such as the environmental compatibility of each Renesas Electronics product. Please use Renesas Electronics products in compliance with all applicable laws and regulations that regulate the inclusion or use of controlled substances, including without limitation, the EU RoHS Directive. Renesas Electronics assumes no liability for damages or losses occurring as a result of your noncompliance with applicable laws and regulations.
- This document may not be reproduced or duplicated, in any form, in whole or in part, without prior written consent of Renesas Electronics.
- Please contact a Renesas Electronics sales office if you have any questions regarding the information contained in this document or Renesas Electronics products, or if you have any other inquiries.
(Note 1) "Renesas Electronics" as used in this document means Renesas Electronics Corporation and also includes its majority-owned subsidiaries.
(Note 2) "Renesas Electronics product(s)" means any product developed or manufactured by or for Renesas Electronics.



SALES OFFICES

Renesas Electronics Corporation

<http://www.renesas.com>

Refer to "<http://www.renesas.com/>" for the latest and detailed information.

Renesas Electronics America Inc.
2880 Scott Boulevard Santa Clara, CA 95050-2554, U.S.A.
Tel: +1-408-586-6000, Fax: +1-408-588-6130

Renesas Electronics Canada Limited
1101 Nicholson Road, Newmarket, Ontario L3Y 9C3, Canada
Tel: +1-905-898-5441, Fax: +1-905-898-3220

Renesas Electronics Europe Limited
Dukes Meadow, Millboard Road, Bourne End, Buckinghamshire, SL8 5FH, U.K
Tel: +44-1628-585-100, Fax: +44-1628-585-900

Renesas Electronics Europe GmbH
Arcadiastrasse 10, 40472 Düsseldorf, Germany
Tel: +49-211-65030, Fax: +49-211-6503-1327

Renesas Electronics (China) Co., Ltd.
7th Floor, Quantum Plaza, No.27 ZhiChunLu Haidian District, Beijing 100083, P.R.China
Tel: +86-10-8235-1155, Fax: +86-10-8235-7679

Renesas Electronics (Shanghai) Co., Ltd.
Unit 204, 205, AZIA Center, No.1233 Lujiazui Ring Rd., Pudong District, Shanghai 200120, China
Tel: +86-21-5877-1818, Fax: +86-21-6887-7858 / -7898

Renesas Electronics Hong Kong Limited
Unit 1601-1613, 16/F., Tower 2, Grand Century Place, 193 Prince Edward Road West, Mongkok, Kowloon, Hong Kong
Tel: +852-2886-9318, Fax: +852 2886-9022/9044

Renesas Electronics Taiwan Co., Ltd.
7F, No. 363 Fu Shing North Road Taipei, Taiwan
Tel: +886-2-8175-9600, Fax: +886 2-8175-9670

Renesas Electronics Singapore Pte. Ltd.
1 HarbourFront Avenue, #06-10, Keppel Bay Tower, Singapore 098632
Tel: +65-6213-0200, Fax: +65-6276-8001

Renesas Electronics Malaysia Sdn.Bhd.
Unit 906, Block B, Menara Amcorp, Amcorp Trade Centre, No. 18, Jln Persiaran Barat, 46050 Petaling Jaya, Selangor Darul Ehsan, Malaysia
Tel: +60-3-7955-9390, Fax: +60-3-7955-9510

Renesas Electronics Korea Co., Ltd.
11F., Samik Lavied' or Bldg., 720-2 Yeoksam-Dong, Kangnam-Ku, Seoul 135-080, Korea
Tel: +82-2-558-3737, Fax: +82-2-558-5141