

# Single Phase Rectifier Bridge

$I_{dAVM} = 21 \text{ A}$   
 $V_{RRM} = 800-1800 \text{ V}$

$V_{RSM}$ V	$V_{RRM}$ V	Type
800	800	VBO 22-08NO8
1200	1200	VBO 22-12NO8
1400	1400	VBO 22-14NO8
1600	1600	VBO 22-16NO8
1800	1800	VBO 22-18NO8

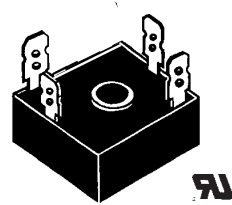
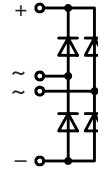

Symbol	Conditions	Maximum Ratings	
$I_{dAV}$	$T_C = 85^\circ\text{C}$ , module	17	A
$I_{dAVM}$	$T_C = 63^\circ\text{C}$ , module	21	A
$I_{FSM}$	$T_{VJ} = 45^\circ\text{C}$ ; $V_R = 0$	t = 10 ms (50 Hz), sine	380 A
		t = 8.3 ms (60 Hz), sine	440 A
	$T_{VJ} = T_{VJM}$ $V_R = 0$	t = 10 ms (50 Hz), sine	360 A
		t = 8.3 ms (60 Hz), sine	400 A
$I^2t$	$T_{VJ} = 45^\circ\text{C}$ $V_R = 0$	t = 10 ms (50 Hz), sine	725 A <sup>2</sup> s
		t = 8.3 ms (60 Hz), sine	800 A <sup>2</sup> s
	$T_{VJ} = T_{VJM}$ $V_R = 0$	t = 10 ms (50 Hz), sine	650 A <sup>2</sup> s
		t = 8.3 ms (60 Hz), sine	650 A <sup>2</sup> s
$T_{VJ}$		-40...+150	°C
$T_{VJM}$		150	°C
$T_{stg}$		-40...+150	°C
$V_{ISOL}$	50/60 Hz, RMS $I_{ISOL} \leq 1 \text{ mA}$	t = 1 min	2500 V~
		t = 1 s	3000 V~
$M_d$	Mounting torque (M5) (10-32 UNF)	2 ±10%	Nm
		18 ±10%	lb.in.
Weight	typ.	22	g
Symbol	Conditions	Characteristic Values	
$I_R$	$T_{VJ} = 25^\circ\text{C}$ ; $T_{VJ} = T_{VJM}$ ;	$V_R = V_{RRM}$	≤ 0.3 mA
		$V_R = V_{RRM}$	≤ 5.0 mA
$V_F$	$I_F = 150 \text{ A}$ ;	$T_{VJ} = 25^\circ\text{C}$	≤ 2.2 V
$V_{T0}$	For power-loss calculations only	0.85	V
$r_T$		12	mΩ
$R_{thJC}$	per diode; DC current	8.2	K/W
	per module	2.05	K/W
$R_{thJK}$	per diode; DC current	9.4	K/W
	per module	2.35	K/W
$d_S$	Creeping distance on surface	12.7	mm
$d_A$	Creepage distance in air	9.4	mm
$a$	Max. allowable acceleration	50	m/s <sup>2</sup>

### Features

- Package with ¼" fast-on terminals
- Isolation voltage 3000 V~
- Planar passivated chips
- Blocking voltage up to 1800 V
- Low forward voltage drop
- UL registered E 72873

### Applications

- Supplies for DC power equipment
- Input rectifiers for PWM inverter
- Battery DC power supplies
- Field supply for DC motors

### Advantages

- Easy to mount with one screw
- Space and weight savings
- Improved temperature and power cycling

### Dimensions in mm (1 mm = 0.0394")

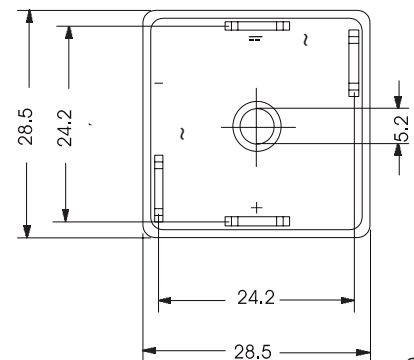
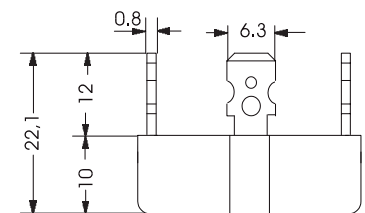

Data according to IEC 60747 and refer to a single diode unless otherwise stated.

IXYS reserves the right to change limits, test conditions and dimensions.

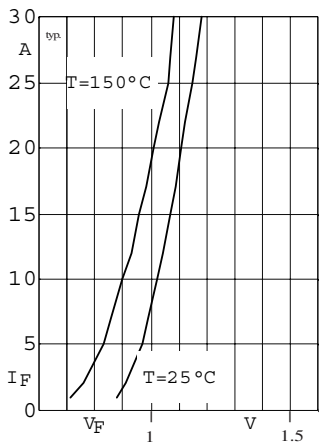

Fig. 1 Forward current versus voltage drop per diode

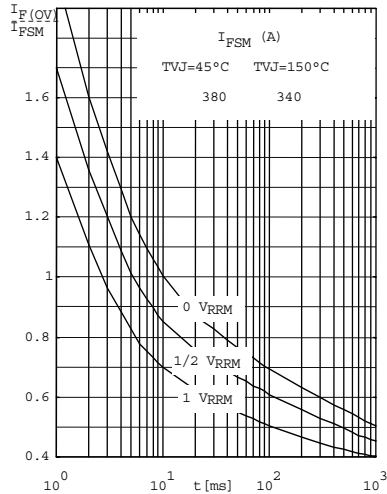

Fig. 2 Surge overload current per diode  
 $I_{FSM}$ : Crest value. t: duration

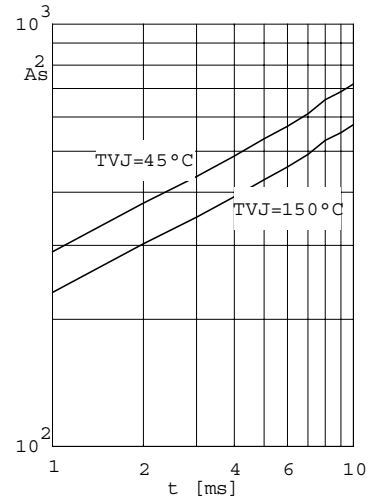

Fig. 3  $\int i^2 dt$  versus time (1-10ms) per diode or thyristor

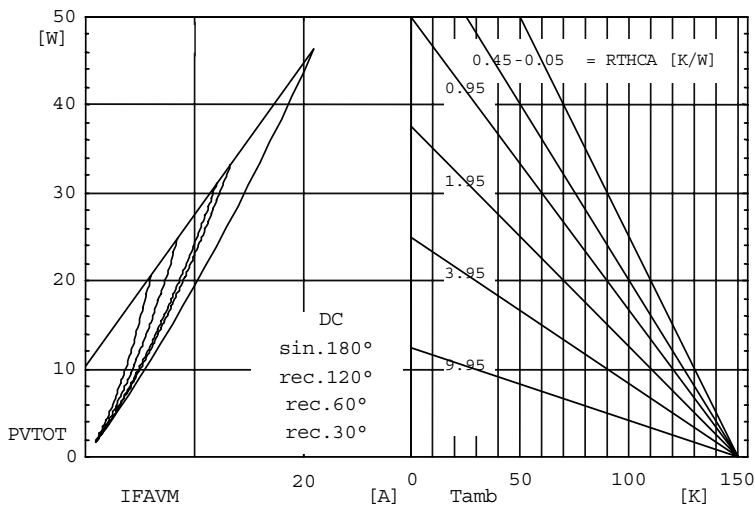

Fig. 4 Power dissipation versus direct output current and ambient temperature

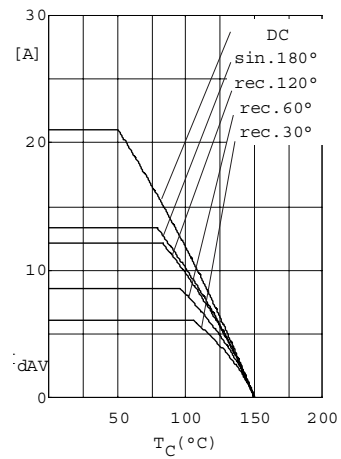

Fig.5 Maximum forward current at case temperature

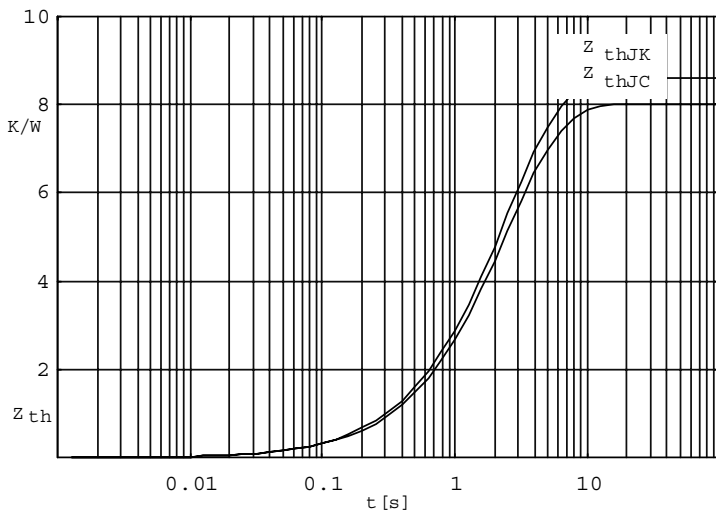

Fig. 6 Transient thermal impedance per diode or thyristor, calculated