



Analog Semiconductor IC

VRD 系列

高速度, 低压差, $\pm 1\%$ 高输出精度
CMOS双路稳压器配ON/OFF开关功能

Rev. C09-08

AnaSem Inc.

..... Future of the analog world



HUA RUI KE

深圳市华瑞科电子有限公司

地址: 深圳市福田区海外装饰大厦A座15A35-15A36
0755-83019307

E-mail: icschi@163.com

电话: 0755-83019251 13823555393
<http://www.hrkdz.hqew.com>



高速度, 低压差, $\pm 1\%$ 高输出精度, 配ON/OFF功能CMOS双路稳压器

VRD 系列

概述

VRD系列乃高速度, 低压差, 高输出电压精度双路稳压器, 以低压差来达成高输出精度的规格。因双路稳压器的管道都是在IC内个别分开的, 串音就能大大减少。VRD系列的电压输出能在指定的温度范围内保证 $\pm 1\%$ 的精度, 而集成电路内以温度系数调整的高准确率参考电压值来做基准。VRD系列以低ESR电容来作输出的稳定作用。而已冲好的ESR电容能由VRD系列在 $CE=V_{SS}$ 的情况下由内置的开关来放电, 能助 V_{OUT} 迅速回复到 V_{SS} 水平。另外, VRD系列也备有电流过高的保护电路, 能防止电流量超越输出三极管的限制电流量。



RoHS
符合标准

特点

- 输出电压范围 0.8V~5.0V (能以每0.05V间隔设定输出电压)
- 工作电压范围 1.6V~6.0V
- 高精度电压输出 $\pm 1\%$ ($V_{out}=1.95V \sim 5.0V$) / $\pm 20mV$ ($V_{out}=0.8V \sim 1.9V$)
- 高电流输出 250mA (个别单道LDO)
- 输入输出压差 Typ.90mV (output=3.0V, $I_{OUT}=100mA$)
- 低电流功耗 Typ. 25 μA / 每道LDO
- 高噪音抑制比 Typ. 75dB at 1KHz
- 低ESR电容 1.0 μF 陶瓷式电容
- 工作温度范围 $-40^{\circ}C \sim +85^{\circ}C$
- 内置高电流限制保护 电流限制 : 300mA
- CL 高速自动放电
- 内置ON/OFF开关电路
- 小型封装 SOT-26 (400mW), SON-6 (600mW), LLP-6 (1000mW)

应用范围

- 电池驱动之产品
- 手机
- 数码相机或摄像机
- 手提式电玩产品
- 手提式电子产品仪器



深圳市华瑞科电子有限公司

产品型号定义



● 输出功能分类选择表

符号	输出 1	输出 2	输出电压范围设定
L	±20mv	±20mv	Vout1=0.80V~1.9V / Vout2=0.80V~1.9V
M	±20mv	±1%	Vout1=0.80V~1.9V / Vout2=1.95V~5.0V
N	±1%	±20mv	Vout1=1.95V~5.0V / Vout2=0.80V~1.9V
P	±1%	±1%	Vout1=1.95V~5.0V / Vout2=1.95V~5.0V

● 电压输出型号编排表

符号	电压	符号	电压	符号	电压	符号	电压	符号	电压
		1A	1.05	2A	2.05	3A	3.05	4A	4.05
		11	1.10	21	2.10	31	3.10	41	4.10
		1B	1.15	2B	2.15	3B	3.15	4B	4.15
		12	1.20	22	2.20	32	3.20	42	4.20
		1C	1.25	2C	2.25	3C	3.25	4C	4.25
		13	1.30	23	2.30	33	3.30	43	4.30
		1D	1.35	2D	2.35	3D	3.35	4D	4.35
		14	1.40	24	2.40	34	3.40	44	4.40
		1E	1.45	2E	2.45	3E	3.45	4E	4.45
		15	1.50	25	2.50	35	3.50	45	4.50
		1F	1.55	2F	2.55	3F	3.55	4F	4.55
		16	1.60	26	2.60	36	3.60	46	4.60
		1G	1.65	2G	2.65	3G	3.65	4G	4.65
		17	1.70	27	2.70	37	3.70	47	4.70
		1H	1.75	2H	2.75	3H	3.75	4H	4.75
08	0.80	18	1.80	28	2.80	38	3.80	48	4.80
0J	0.85	1J	1.85	2J	2.85	3J	3.85	4J	4.85
09	0.90	19	1.90	29	2.90	39	3.90	49	4.90
0K	0.95	1K	1.95	2K	2.95	3K	3.95	4K	4.95
10	1.00	20	2.00	30	3.00	40	4.00	50	5.00

PIN脚排位 / IC封装记号 (SOT-26)

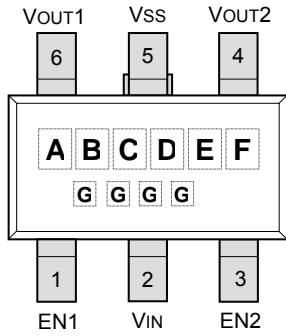

(顶视图)

● **Pin脚排位**

位置	记号	解说
1	EN1	LDO 1 ON/OFF检测
2	VIN	电压输入
3	EN2	LDO 2 ON/OFF检测
4	VOUT2	LDO 2 电压输出
5	VSS	接地
6	VOUT1	LDO 1 电压输出

● **IC封装记号**

位置	记号	解说
A	D	产品系列标记
BC	08~50	LDO 1 电压输出
DE	08~50	LDO 2 电压输出
F	X	电容放电功能
G	厂方设定	生产批号

PIN脚排位 / IC封装记号 (SON-6)

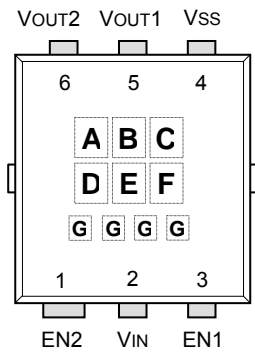

(Top view)

● **Pin 脚排位**

位置	记号	解说
1	EN2	LDO 2 ON/OFF检测
2	VIN	电压输入
3	EN1	LDO 1 ON/OFF检测
4	VSS	接地
5	VOUT1	LDO 1 电压输出
6	VOUT2	LDO 2 电压输出

● **IC封装记号**

位置	记号	解说
A	D	产品系列标记
BC	08~50	LDO 1 电压输出
DE	08~50	LDO 2 电压输出
F	X	电容放电功能
G	厂方设定	生产批号

PIN脚排位 / IC封装记号(LLP-6)

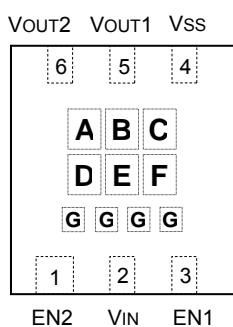

(顶视图)

● Pin脚排位

位置	记号	解说
1	EN2	LDO 2 ON/OFF检测
2	VIN	电压输入
3	EN1	LDO 1 ON/OFF检测
4	VSS	接地
5	VOUT1	LDO 1 电压输出
6	VOUT2	LDO 2 电压输出

● IC封装记号

位置	记号	解说
A	D	产品系列标记
BC	08~50	LDO 1 电压输出
DE	08~50	LDO 2 电压输出
F	X	电容放电功能
G	厂方设定	生产批号

IC电路图

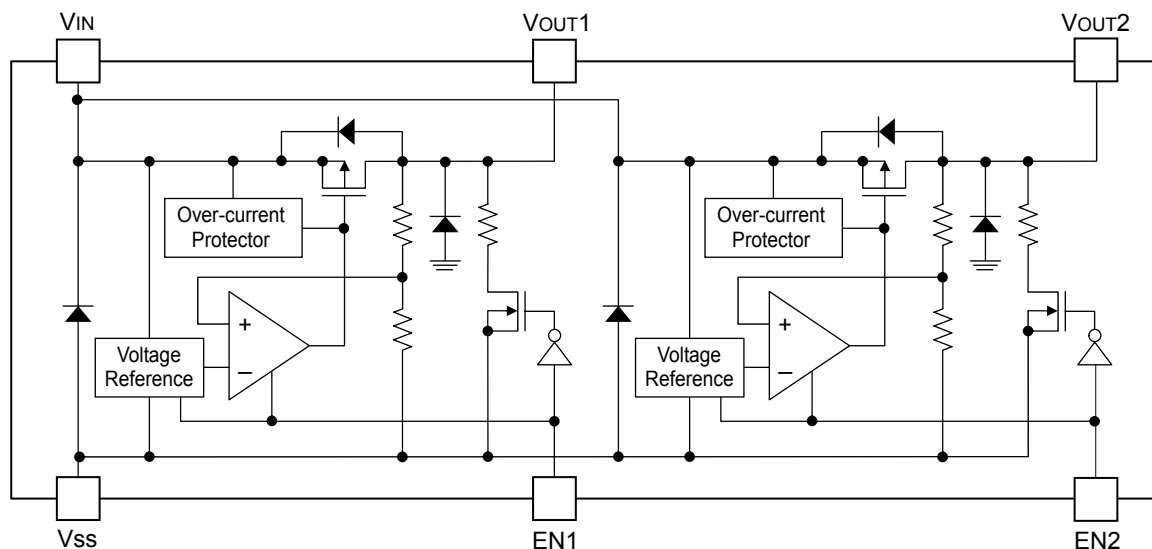

绝对最大工作范围

项目	符号	规格	单位	
输入电压范围	VIN	-0.3 ~ +7.0	V	
输出电流	IOUT	500	mA	
输出电压范围	VOUT	VSS -0.3 ~ VIN +0.3	V	
功率耗散 ※1)	SOT-26	PD	400 (on PCB)	mW
	SON-6	PD	600 (on PCB)	mW
	LLP-6	PD	1000 (on PCB)	mW
工作温度范围	TOPR	-40 ~ +85	°C	
储存温度范围	TSTG	-55 ~ +125	°C	

注:

※1) 功率耗散规格是依照IC已上PCB板的条件来定。
而PCB板的尺寸为 50mm×50mm×1.6mm。

典型应用电路

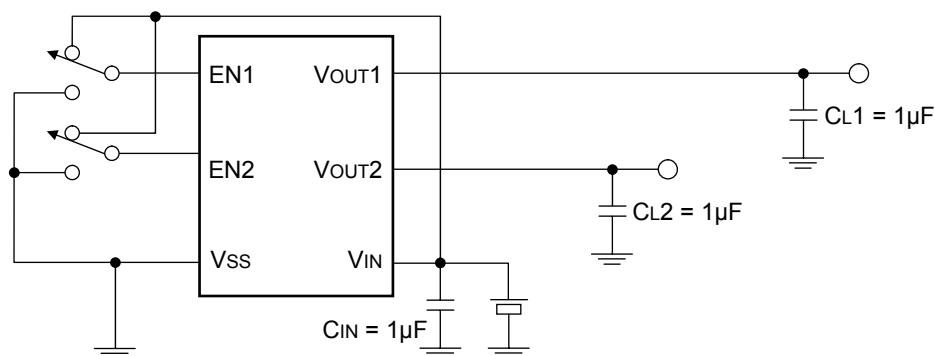

电子规格

(Ta=25°C 除非另有注明)

项目	符号	条件		最低	一般	最高	单位	测试电路
输出电压范围	V _{OUT}	V _{OUT} +1.0V ≤ V _{IN} ≤ 6.0V I _{OUT} =30mA Ta=-40°C ~ +85°C	V _{OUT} ≥ 1.95V	V _{OUT} × 0.99	V _{OUT}	V _{OUT} × 1.01	V	1
			V _{OUT} ≤ 1.90V	-20	-	+20	mV	
输出电流	I _{OUT}	V _{IN} ≥ V _{OUT} +1.0V	0.9V ≤ V _{OUT} ≤ 1.15V	-	250	-	mA	1
			1.2V ≤ V _{OUT} ≤ 1.65V	-	250	-	mA	
			1.7V ≤ V _{OUT} ≤ 2.25V	-	250	-	mA	
			2.3V ≤ V _{OUT} ≤ 2.85V	-	250	-	mA	
			2.9V ≤ V _{OUT} ≤ 3.45V	-	250	-	mA	
			3.5V ≤ V _{OUT} ≤ 4.05V	-	250	-	mA	
			4.0V ≤ V _{OUT} ≤ 5.00V	-	250	-	mA	
输入输出压差	V _{DROP}	I _{OUT} =100mA	0.9V ≤ V _{OUT} ≤ 1.15V	-	580	910	mV	1
			1.2V ≤ V _{OUT} ≤ 1.65V	-	210	340	mV	
			1.7V ≤ V _{OUT} ≤ 2.25V	-	130	205	mV	
			2.3V ≤ V _{OUT} ≤ 2.85V	-	100	150	mV	
			2.9V ≤ V _{OUT} ≤ 3.45V	-	90	137	mV	
			3.5V ≤ V _{OUT} ≤ 4.05V	-	85	125	mV	
			4.0V ≤ V _{OUT} ≤ 5.00V	-	80	115	mV	

电子规格 (续)

(Ta=25°C 除非另有注明)

项目	符号	条件	最低	一般	最高	单位	测试电路
电流功耗	IDD	VIN=VOUT+1.0V, VOUT=Open, IOUT=0mA	-	50	80	μA	2
静态电流消耗	ISTB	EN=VSS	-	0.01	0.1	μA	2
输入电压范围	VIN		1.6	-	6.0	V	1
负载调节	ΔVOUT	VIN=VOUT+1.0V, IOUT=0.1mA ~ 100mA	-	10	40	mV	1
交流电源电压变化	$\frac{\Delta V_{OUT}}{\Delta V_{IN} \cdot V_{OUT}}$	VOUT+1.0V ≤ VIN ≤ 6.0V, IOUT=30mA	-	0.01	0.1	%/V	1
噪音抑制比	Rr	VIN=VOUT+1.0V, f=1KHz, ΔVRIP=0.5VP-P, IOUT=30mA	-	75	-	dB	3
电流限制	ILIMIT	EN=VIN	300	-	-	mA	1
短路电流	ISHORT	VIN=VOUT+1.0V, VOUT=0V	-	40	-	mA	1
电压输出-温度稳定性	$\frac{\Delta V_{OUT}}{\Delta T_a \cdot V_{OUT}}$	VEN=VIN, IOUT=300mA Ta=-40°C ~ +85°C		±20		ppm/°C	1
EN 高端电压	VENH		1.2	-	6.0	V	1
EN 低端电压	VENL		-	-	0.3	V	1
EN 高端电流	IENH	VEN= VIN	-0.1	-	0.1	μA	1
EN 低端电流	IENL	VEN= VSS	-0.1	-	0.1	μA	1
CL 自动放电阻抗值	RDIS	VIN=6.0V, VOUT=4.0V, VEN= VSS	-	160	-	Ω	1



测试电路

- **电路 (1)** – 输出电压, 输出电流, CL 自动放电电阻抗值, EN 高端电压, EN 低端电压, EN 高端电流, EN 低端电流

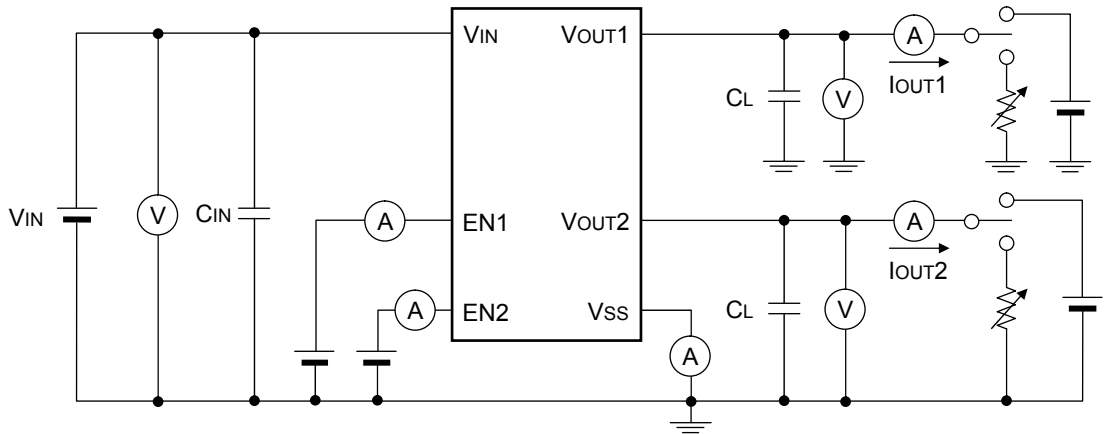

- **电路 (2)** – 电流功耗, 静态电流消耗

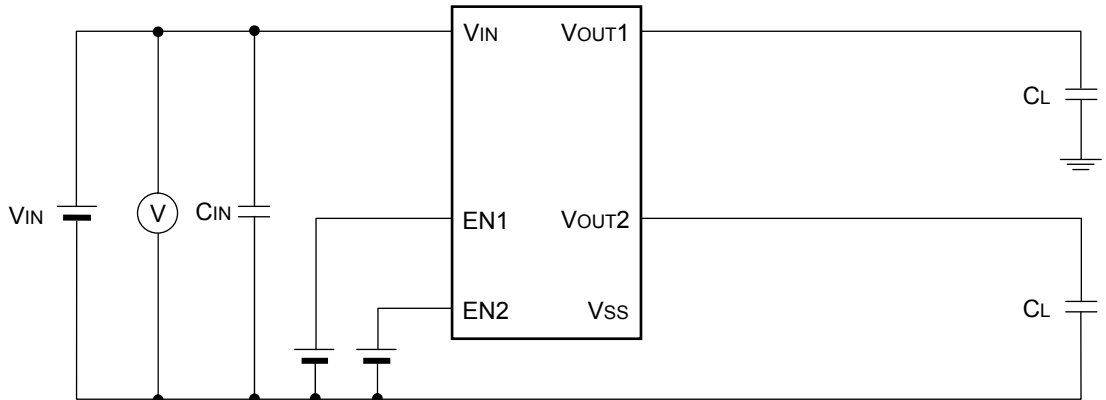

- **电路 (3)** – 输出噪音抑制比

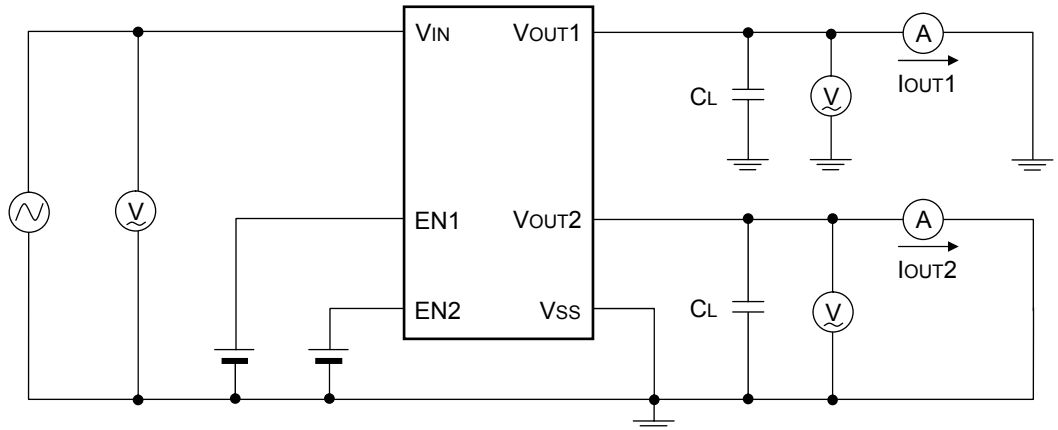

工作原理解说

- 一般运作

请参考以下VRD系列的电压控制电路图;

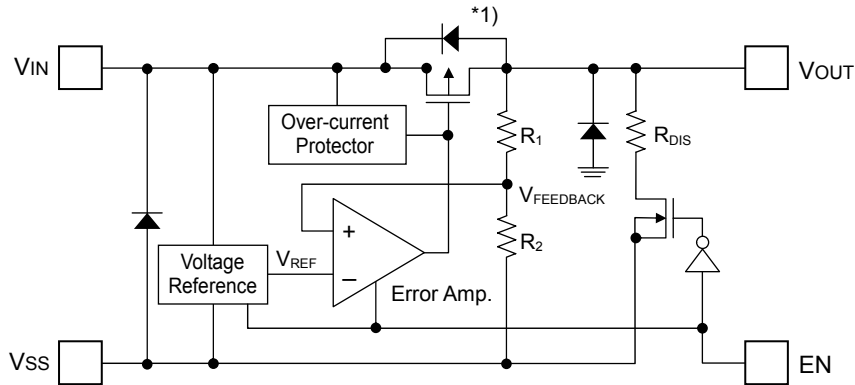

运用电路图内的 **Error Amplifier**, 参考电压(V_{REF})能与 $V_{FEEDBACK}$ 作比较, 而参数电压侧由回输电阻 R_1 和 R_2 除开。这样电压供应到输出的三极管(请参考注*1)来保持稳定的电压输出避免其他从电压输入因负极回输电路而产生的不稳定影响。

注 *1)

VRD系列以内置有连接着P-沟道三极管为输出三极管。为了避免VRD系列稳压器因反向电流从VOUT端经过寄生二极管通至VIN端而损坏, VOUT值应设至不高于VIN+0.3V.

- **EN端 (稳压器电路运作开关功能) 和 CL自动放电功能**

VRD 系列能以EN端来作关闭动作。此时, 当在EN端的信号成关闭水平时, 内置的P-极三极管是在OFF的状态, 所有稳压器的内部电路运作会被停止来节省电流功耗。在关闭的模式时, VRH系列能自动放电阻抗(R_{DIS} ; 160 Ω)来把存留在CL 的电荷放出, 如此VOUT端的电压能迅速地回到VSS的水平。

- **输出端电容(CL)**

基于相位补偿的功能, 输出端电容(CL)需要尽量靠近地连接与VOUT端与VSS端。 建议的电容为最少是1.0 μ F 值的陶瓷式电容。当然, 电容值是基于个别不一的应用方式。此外, 为了保持稳定的电源供应, 建议采用一颗最少为1.0 μ F的输入端电容(CIN)接于VIN端与VSS端之间。

- **过量电流限制和短路保护**

VRD系列以内置的电流限制电路来达成过量电流保护的功用。当负载电流达到限制的电流水平, 输出电压会下降, 同时间输出电流也会相应地减低。在输出端短路的情况下一般的电流值为40mA。

一般特征 – 输出电压 vs. 输出电流

● VRD (V_{OUT}=1.5V)

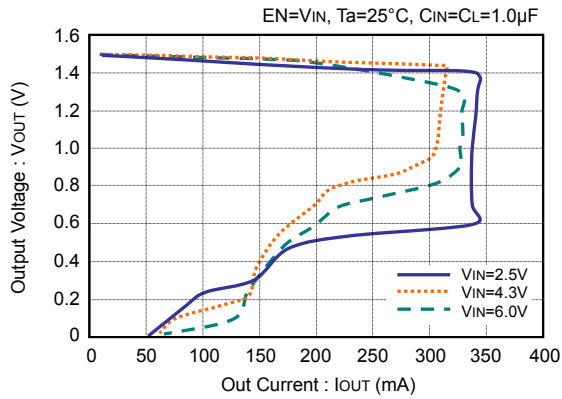

● VRD (V_{OUT}=1.5V)

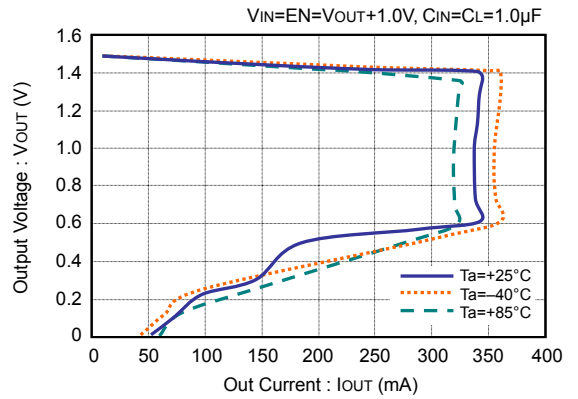

● VRD (V_{OUT}=1.8V)

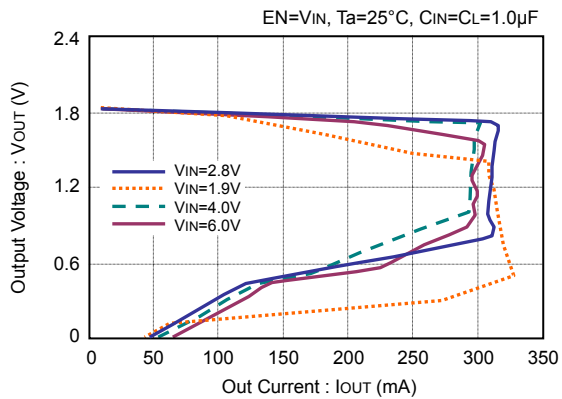

● VRD (V_{OUT}=1.8V)

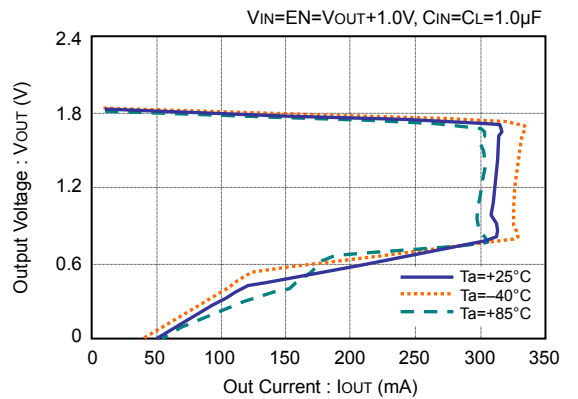

一般特征 – 输出电压 vs. 输出电流 (续)

● VRD (V_{OUT}=2.8V)

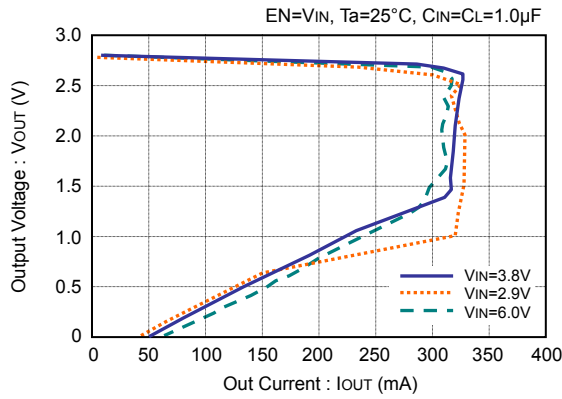

● VRD (V_{OUT}=2.8V)

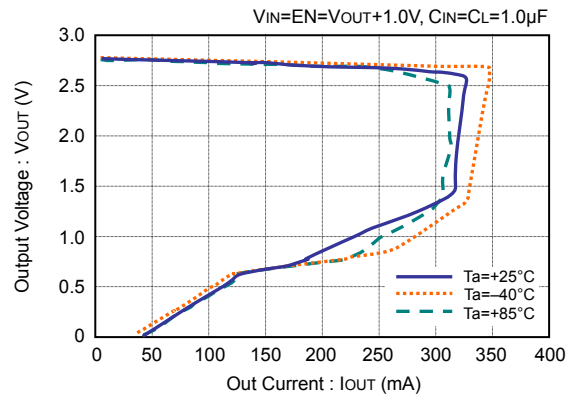

● VRD (V_{OUT}=3.3V)

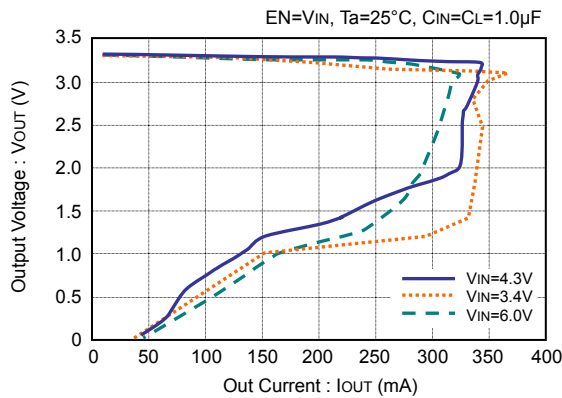

● VRD (V_{OUT}=3.3V)

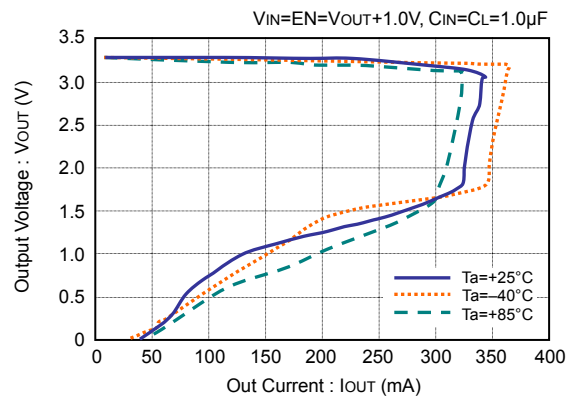

一般特征 – 输出电压 vs. 输入电压

● VRD (V_{OUT}=1.5V)

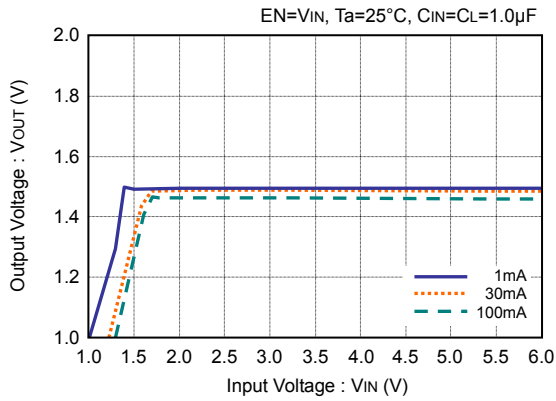

● VRD (V_{OUT}=1.5V)

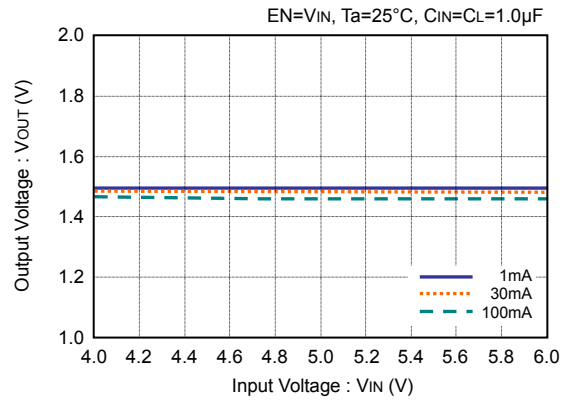

● VRD (V_{OUT}=1.8V)

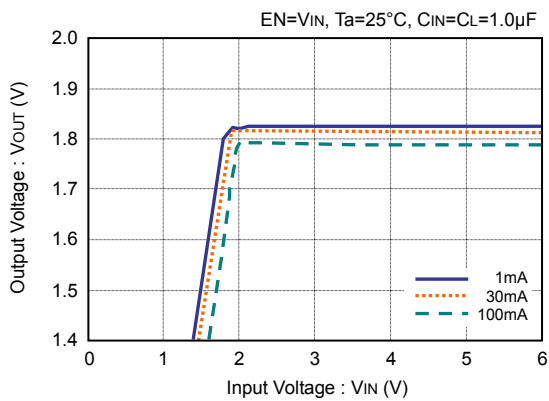

● VRD (V_{OUT}=1.8V)

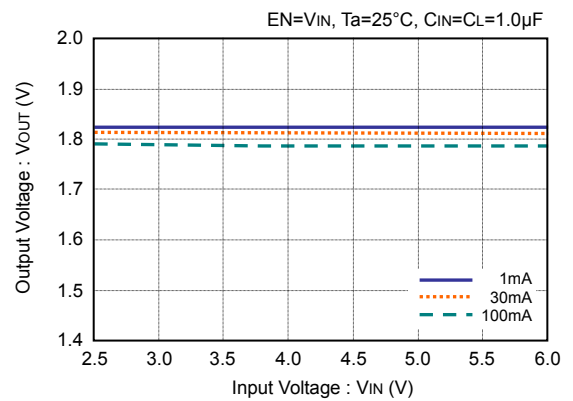

一般特征 – 输出电压 vs. 输入电压 (续)

● VRD (V_{OUT}=2.8V)

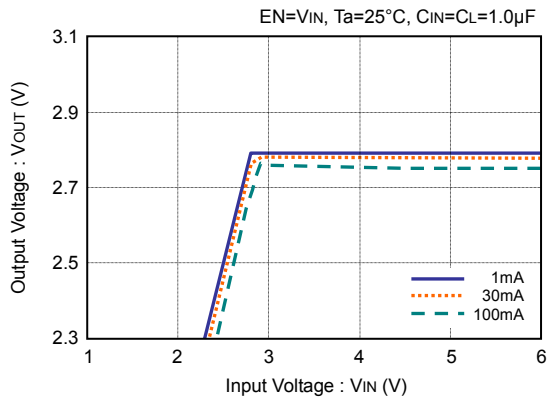

● VRD (V_{OUT}=2.8V)

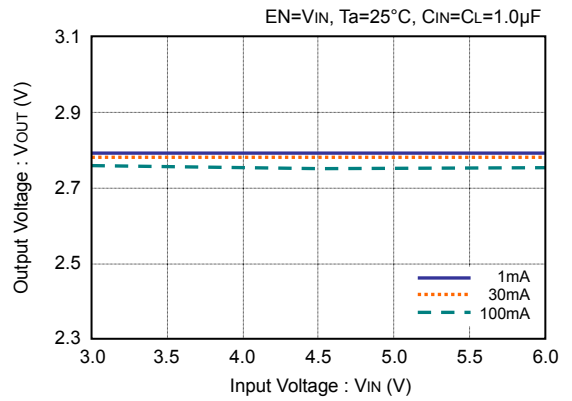

● VRD (V_{OUT}=3.3V)

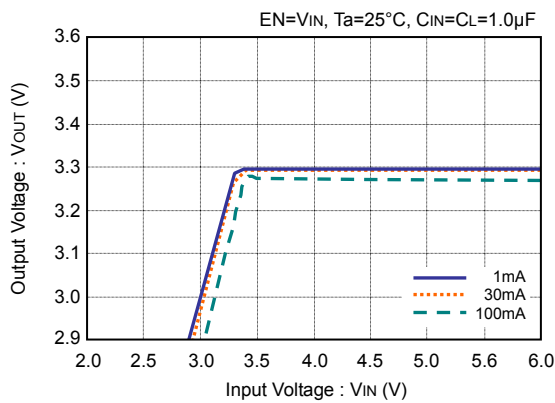

● VRD (V_{OUT}=3.3V)

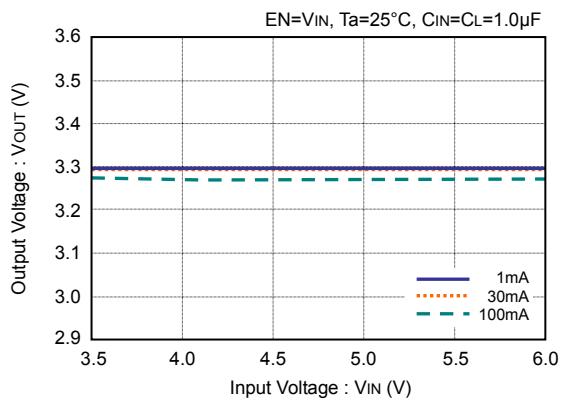

一般特征 – 压差 vs. 输出电流

● VRD (V_{OUT}=1.5V)

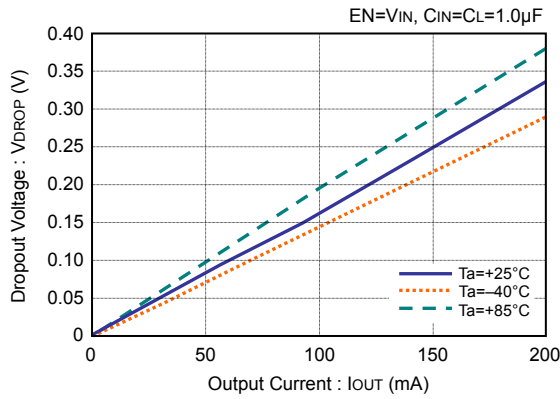

● VRD (V_{OUT}=1.8V)

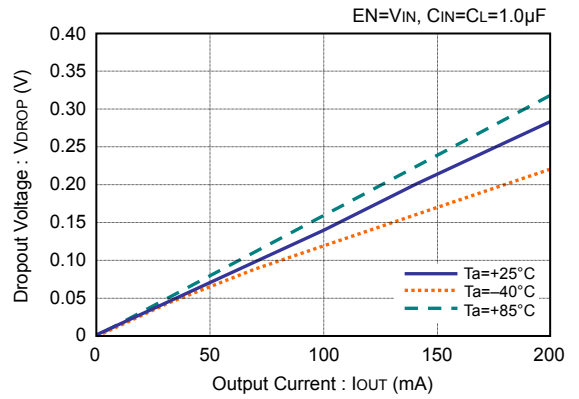

● VRD (V_{OUT}=2.8V)

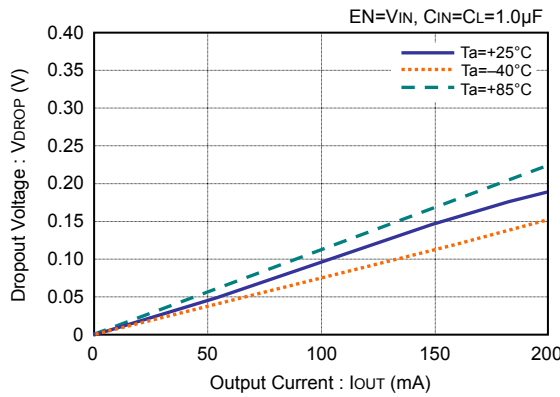

● VRD (V_{OUT}=3.3V)

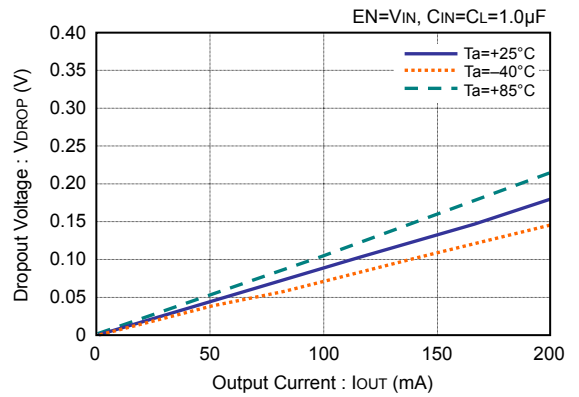

一般特征 – 输出电压 vs. 工作温度参数

● VRD (V_{OUT}=1.5V)

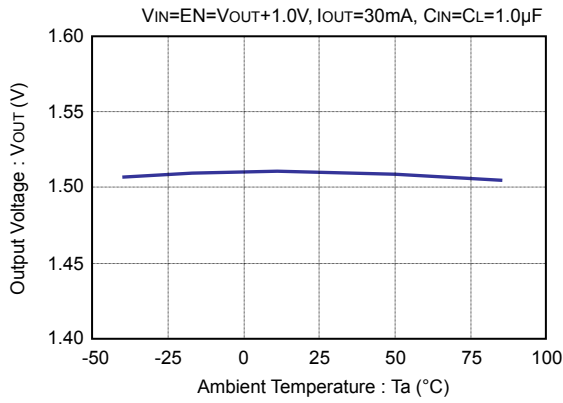

● VRD (V_{OUT}=1.8V)

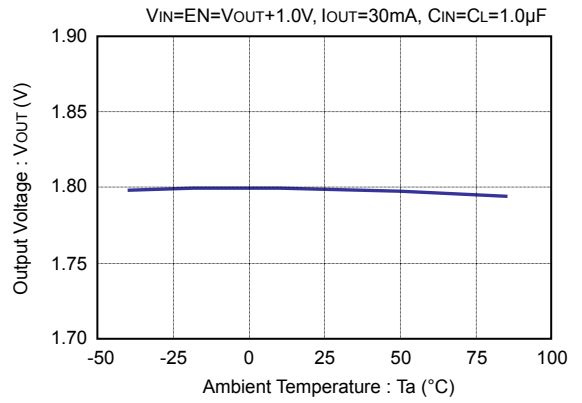

● VRD (V_{OUT}=2.8V)

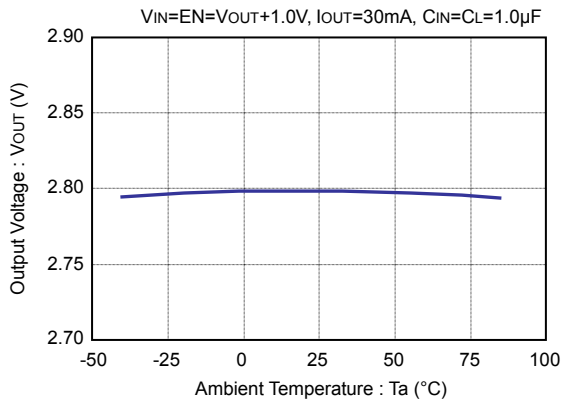

● VRD (V_{OUT}=3.3V)

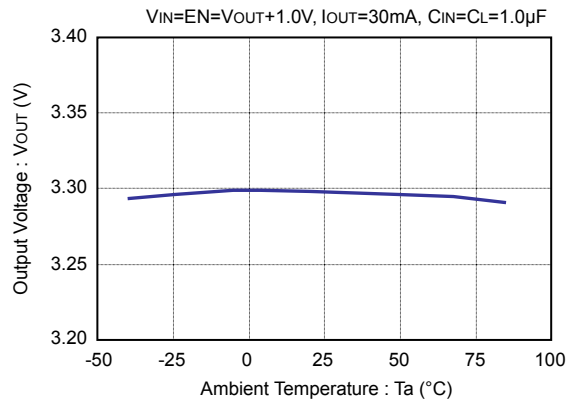

深圳市华瑞科电子有限公司

一般特征 – 电源电流 vs. 工作温度参数

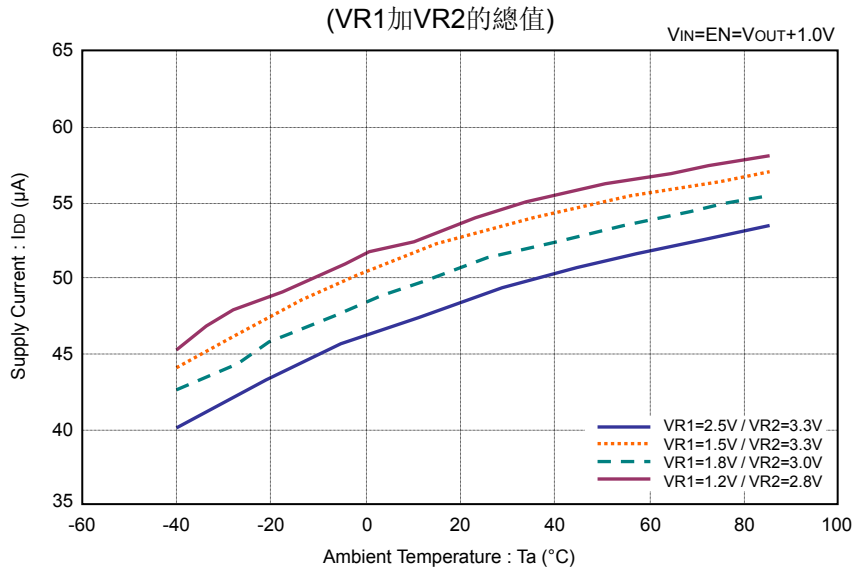

一般特征 – 串音

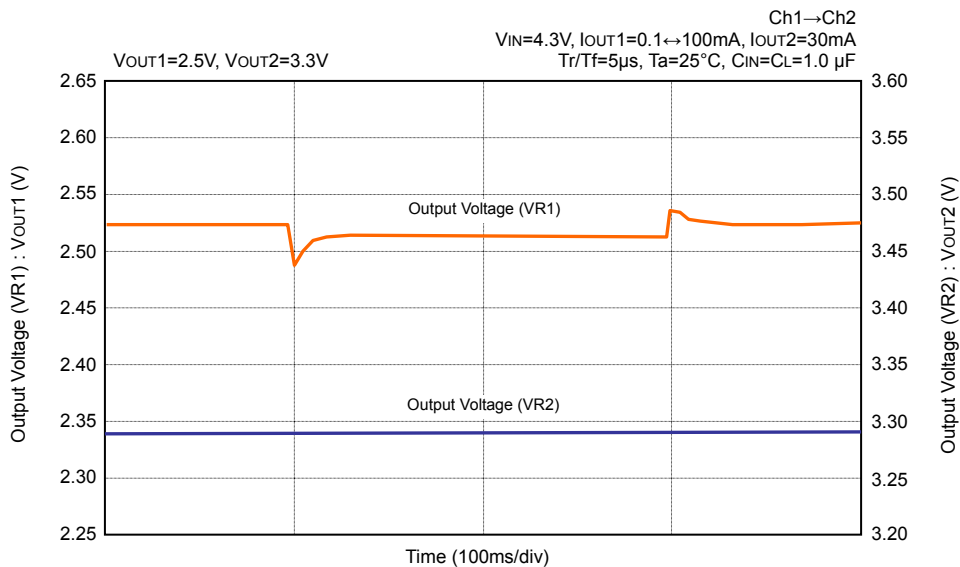

一般特征 – 电源电流 vs. 输入电压

● VRD (V_{OUT}=1.5V)

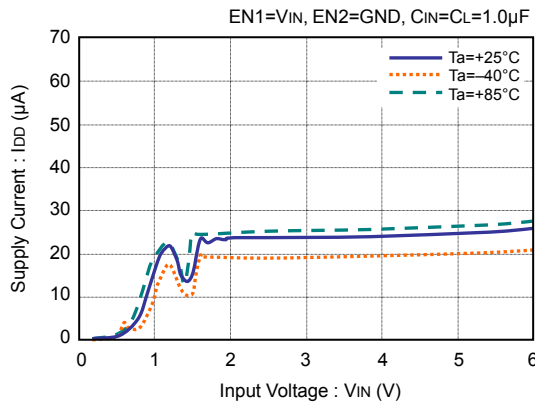

● VRD (V_{OUT}=1.8V)

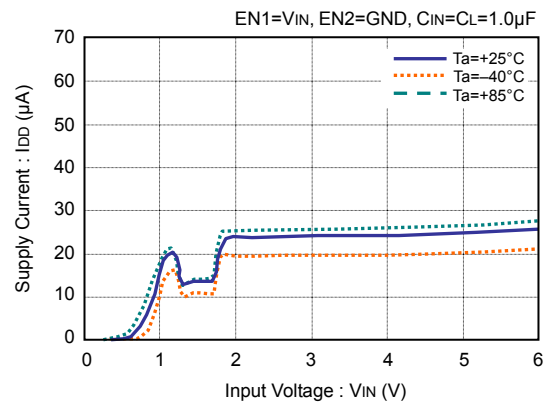

● VRD (V_{OUT}=2.8V)

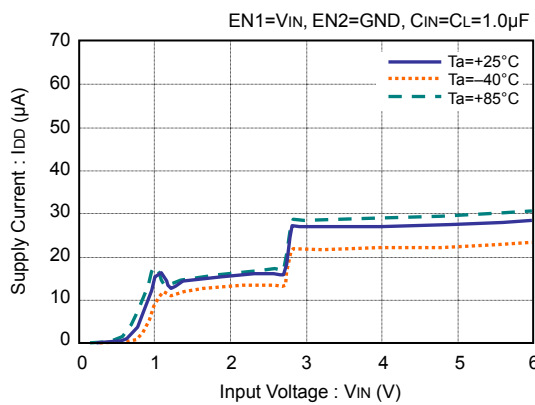

● VRD (V_{OUT}=3.3V)

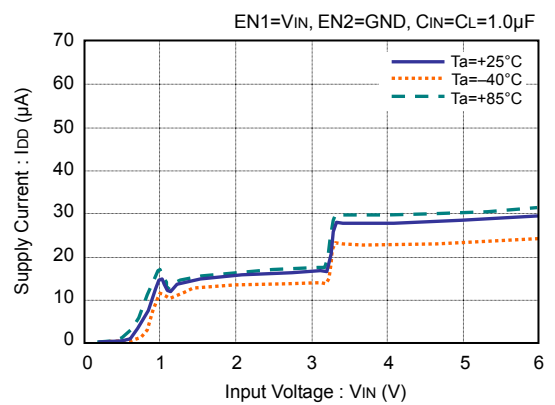

一般特征 – 负载瞬态响应

● VRD (V_{OUT}=1.5V)

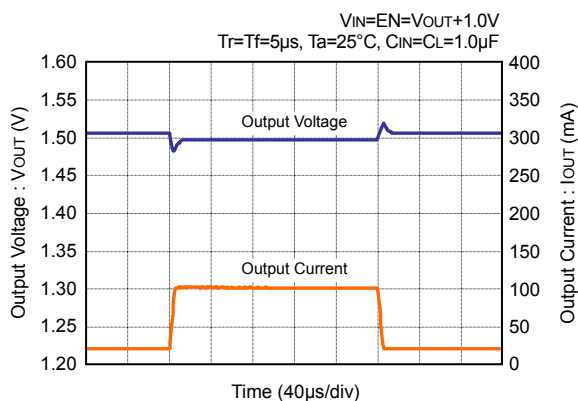

● VRD (V_{OUT}=1.8V)

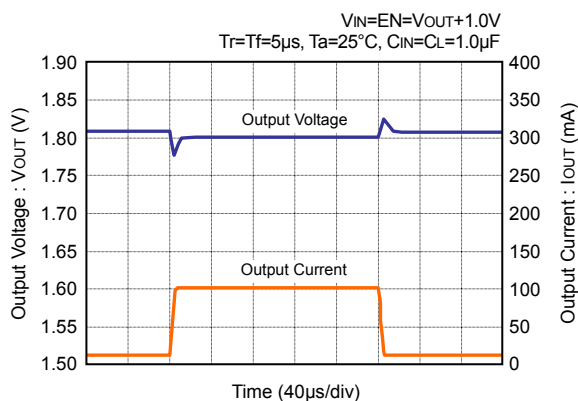

● VRD (V_{OUT}=2.8V)

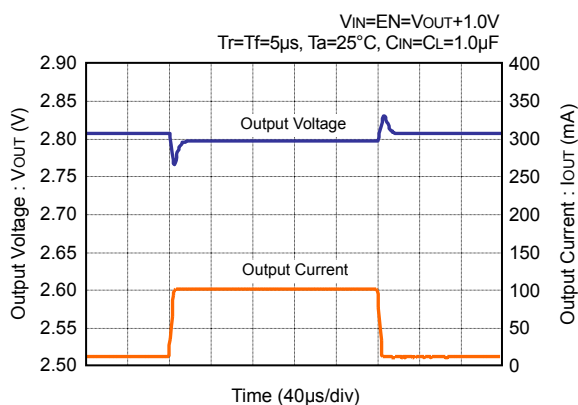

● VRD (V_{OUT}=3.3V)

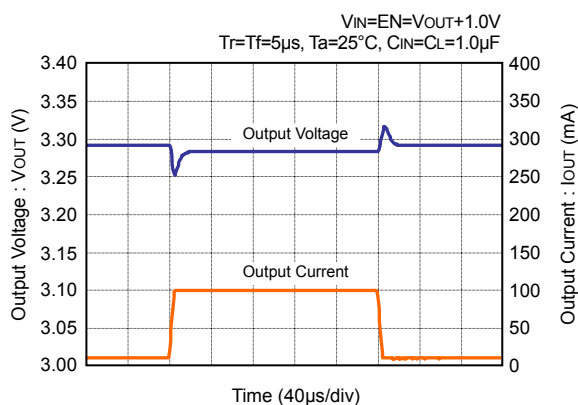

一般特征 – 输入瞬态响应 ($I_{OUT}=1mA$)

● VRD ($V_{OUT}=1.5V$)

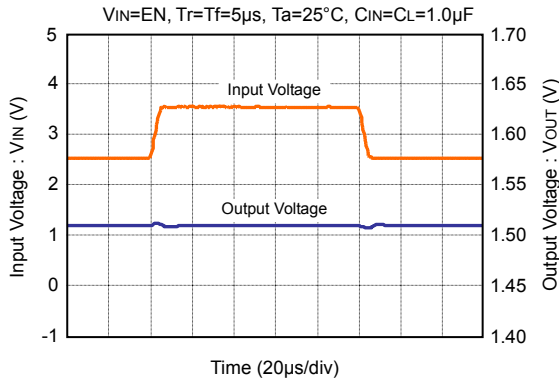

● VRD ($V_{OUT}=1.8V$)

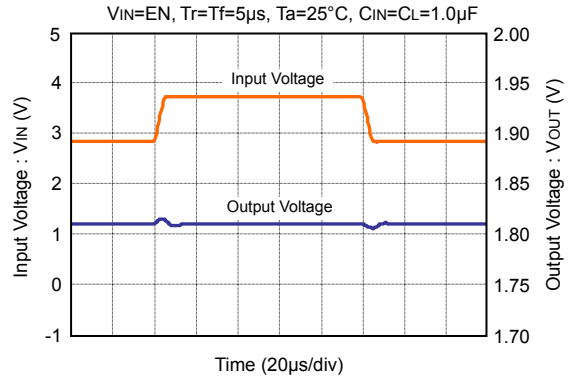

● VRD ($V_{OUT}=2.8V$)

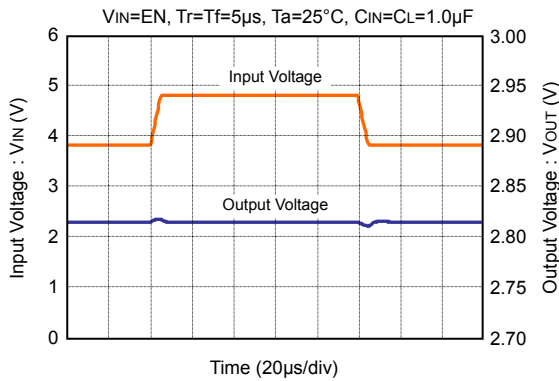

● VRD ($V_{OUT}=3.3V$)

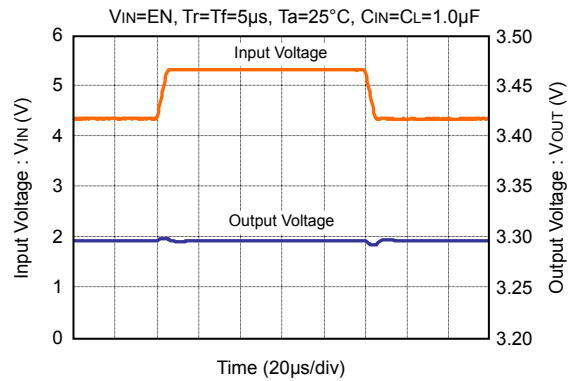

一般特征 – 输入瞬态响应 (I_{OUT}=30mA)

● VRD (V_{OUT}=1.5V)

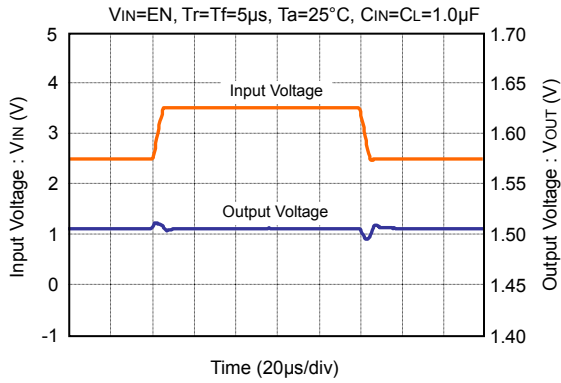

● VRD (V_{OUT}=1.8V)

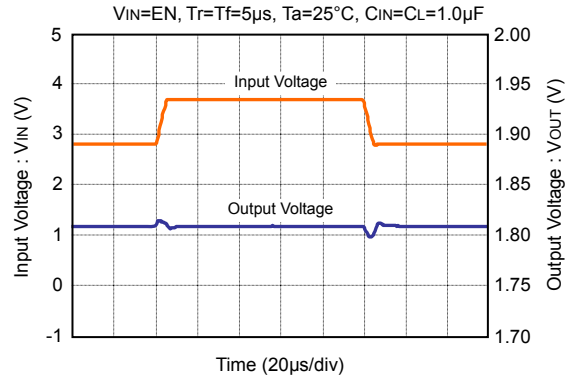

● VRD (V_{OUT}=2.8V)

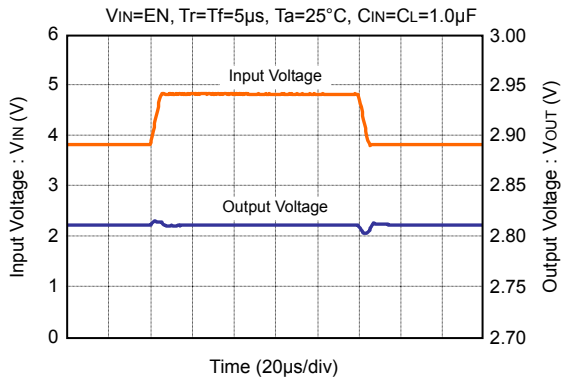

● VRD (V_{OUT}=3.3V)

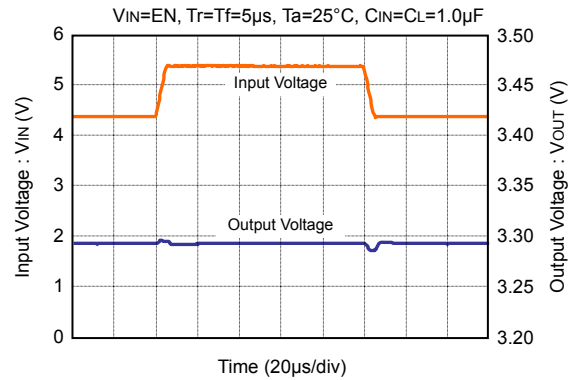

一般特征 – 输入瞬态响应 ($I_{OUT}=100mA$)

● VRD ($V_{OUT}=1.5V$)

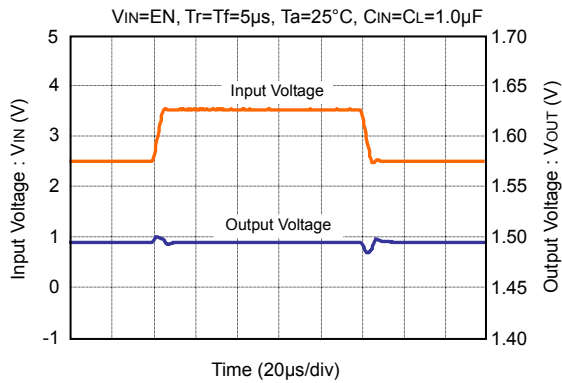

● VRD ($V_{OUT}=1.8V$)

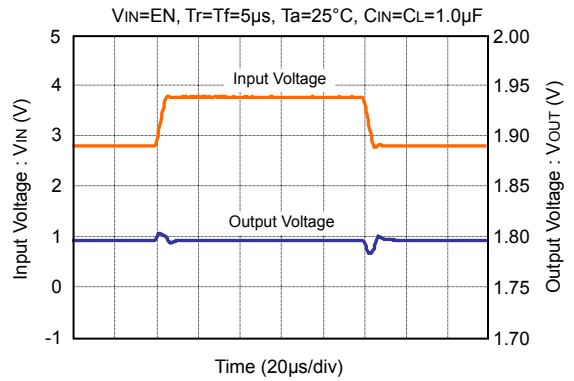

● VRD ($V_{OUT}=2.8V$)

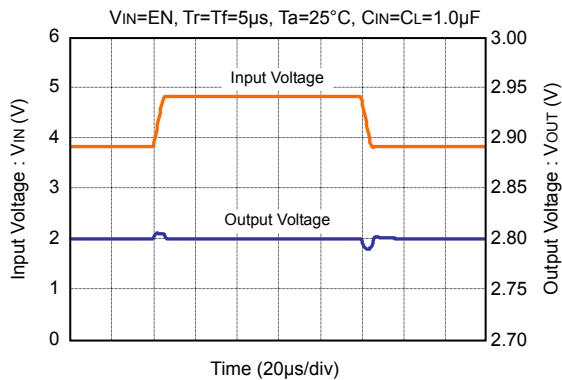

● VRD ($V_{OUT}=3.3V$)

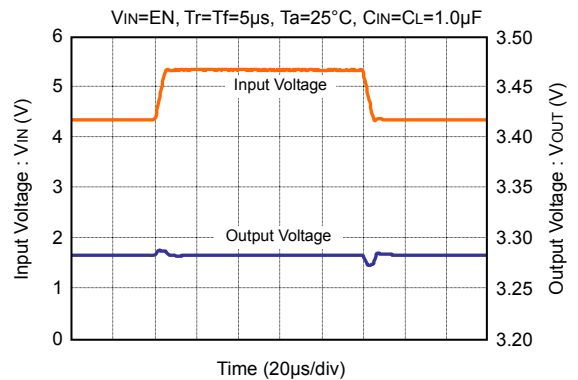

一般特征 – 输入上升时间 ($I_{OUT}=1mA$)

● VRD ($V_{OUT}=1.5V$)

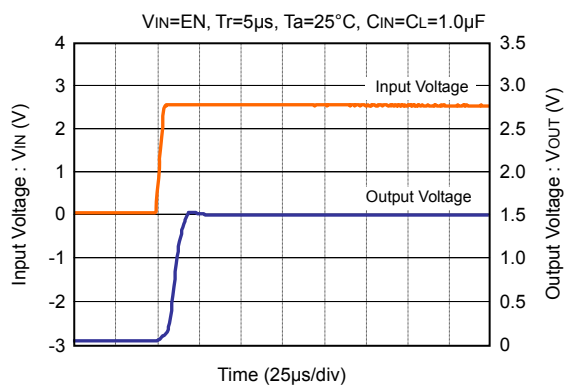

● VRD ($V_{OUT}=1.8V$)

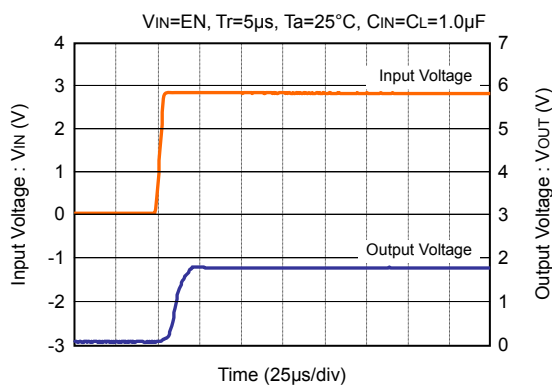

● VRD ($V_{OUT}=2.8V$)

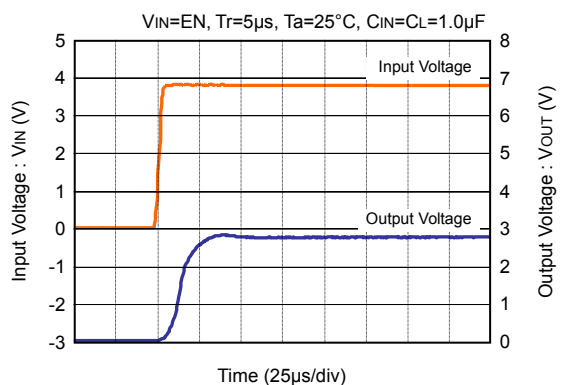

● VRD ($V_{OUT}=3.3V$)

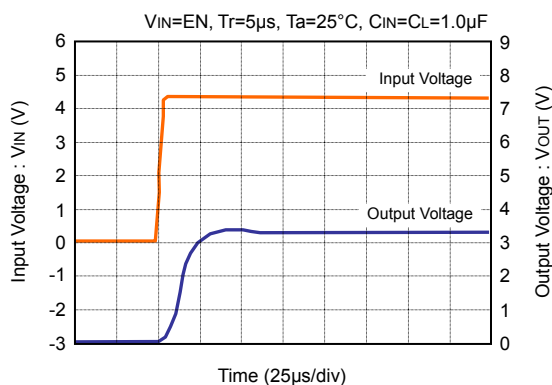

一般特征 – 输入上升时间 (I_{OUT}=30mA)

● VRD (V_{OUT}=1.5V)

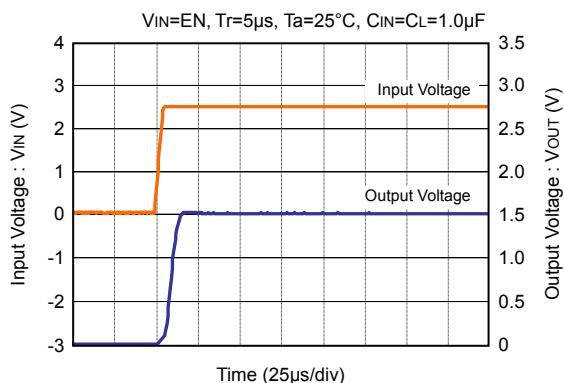

● VRD (V_{OUT}=1.8V)

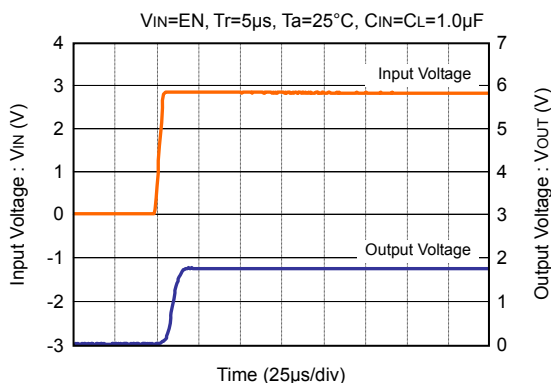

● VRD (V_{OUT}=2.8V)

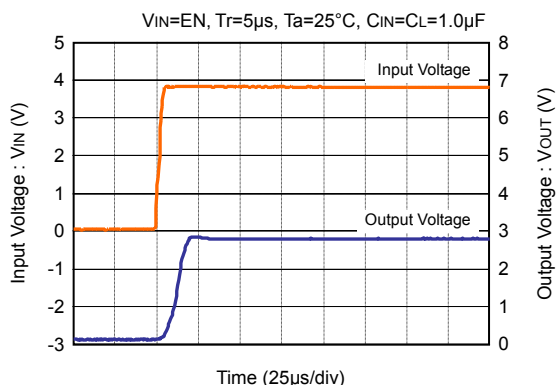

● VRD (V_{OUT}=3.3V)

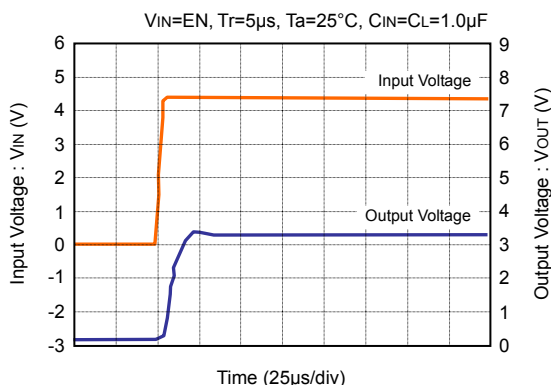

一般特征 – 输入上升时间 (I_{OUT}=100mA)

● VRD (V_{OUT}=1.5V)

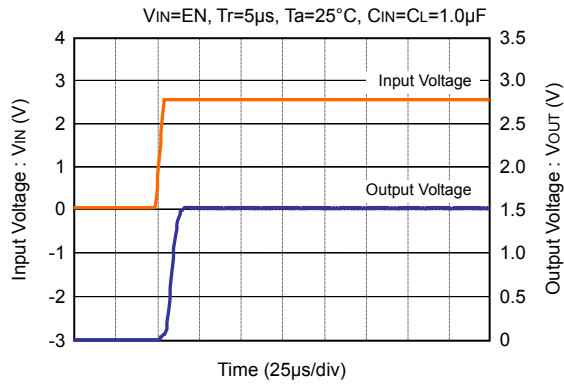

● VRD (V_{OUT}=1.8V)

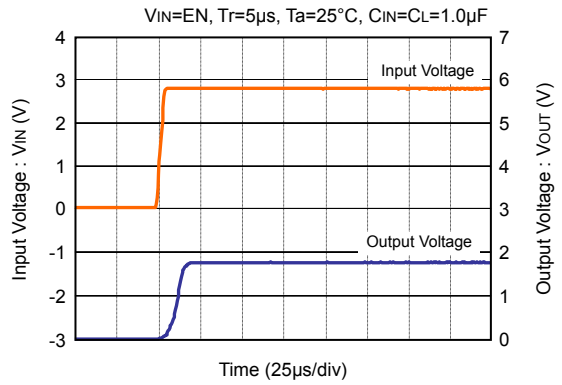

● VRD (V_{OUT}=2.8V)

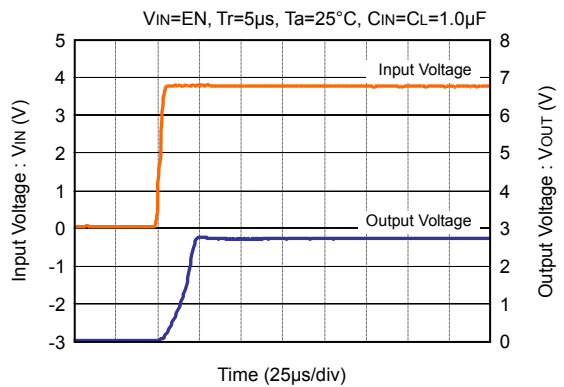

● VRD (V_{OUT}=3.3V)

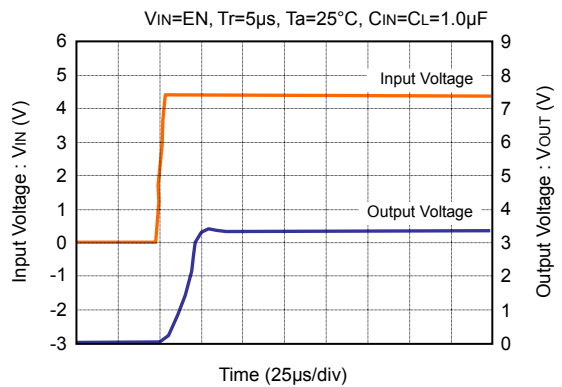

一般特征 – EN开关上升时间 (IOUT=1mA)

● VRD (VOUT=1.5V)

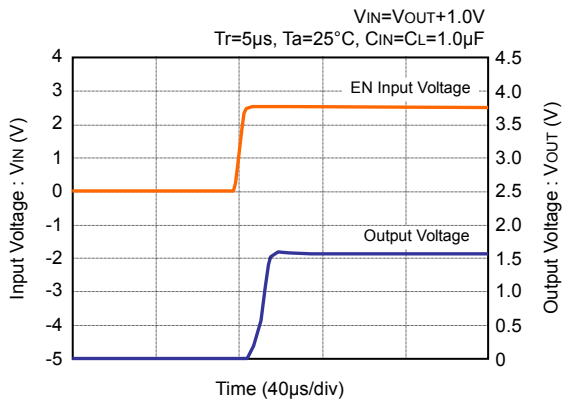

● VRD (VOUT=1.8V)

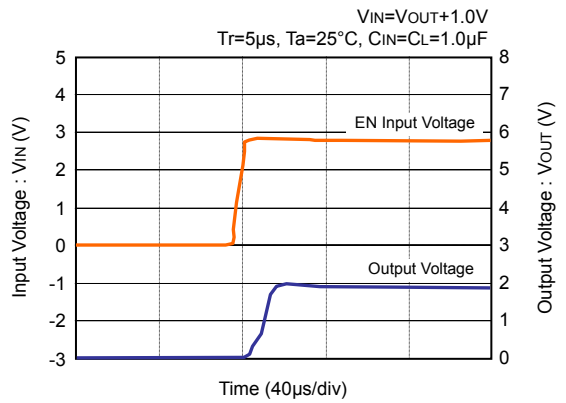

● VRD (VOUT=2.8V)

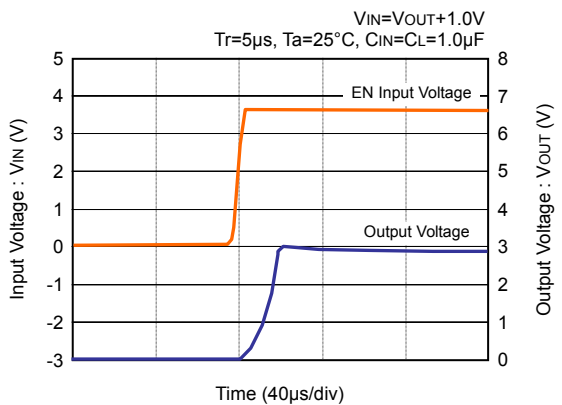

● VRD (VOUT=3.3V)

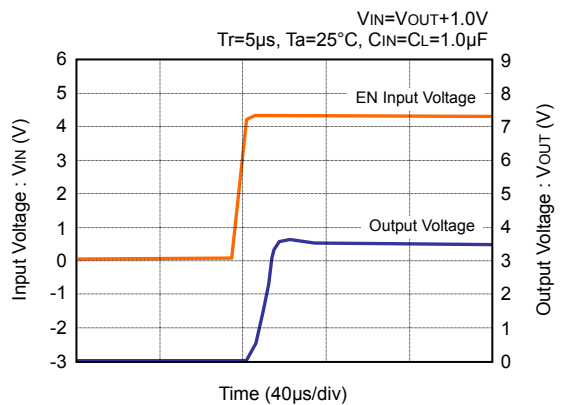

一般特征 – EN开关上升时间 (I_{OUT}=30mA)

● VRD (V_{OUT}=1.5V)

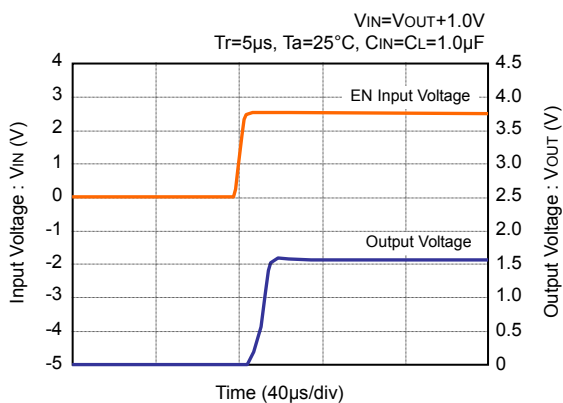

● VRD (V_{OUT}=1.8V)

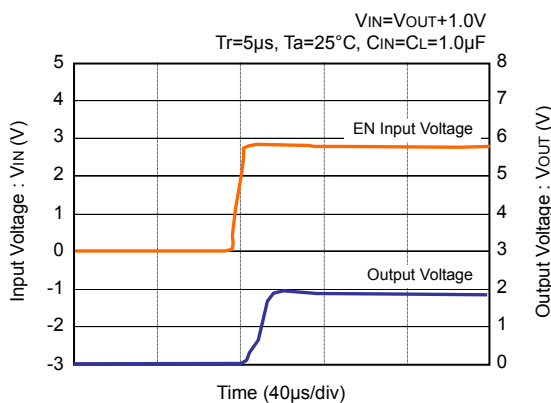

● VRD (V_{OUT}=2.8V)

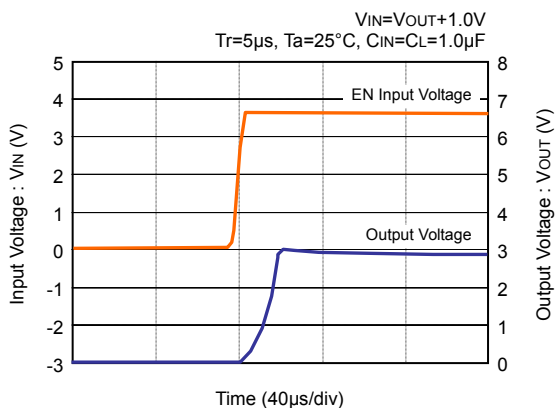

● VRD (V_{OUT}=3.3V)

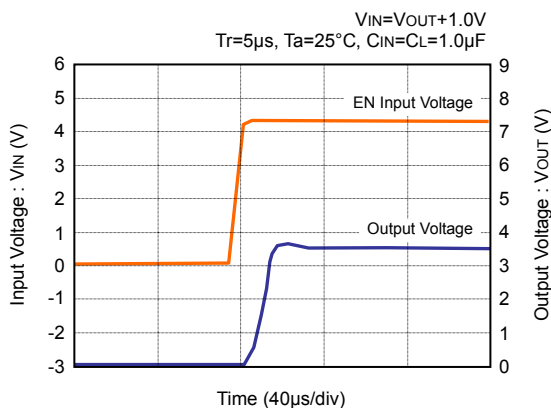

一般特征 – EN开关上升时间 (IOUT=100mA)

● VRD (VOUT=1.5V)

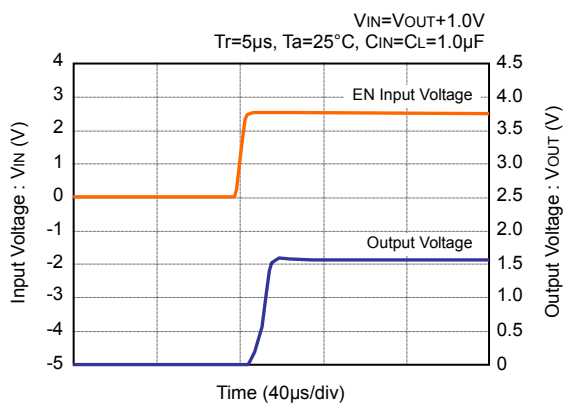

● VRD (VOUT=1.8V)

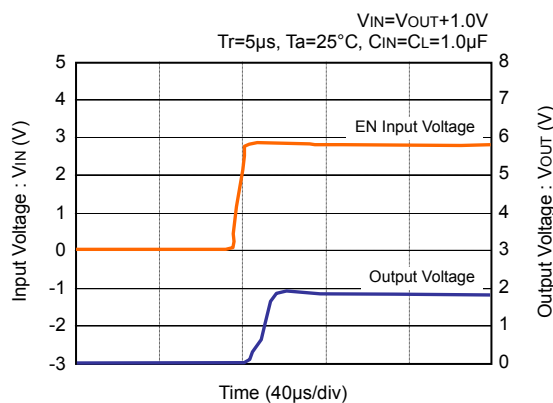

● VRD (VOUT=2.8V)

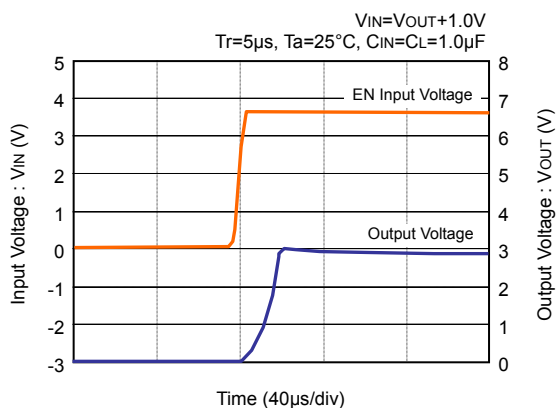

● VRD (VOUT=3.3V)

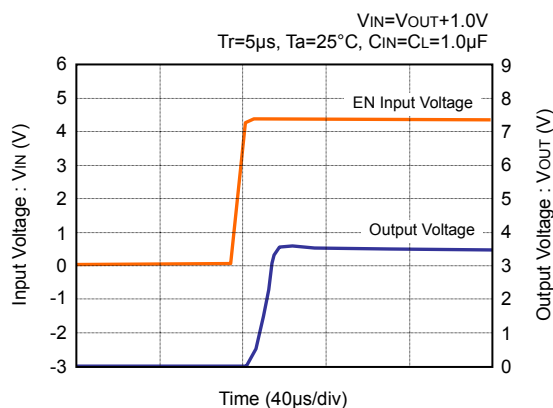

一般特征 – 输出噪音抑制比

● VRD (VOUT=1.5V)

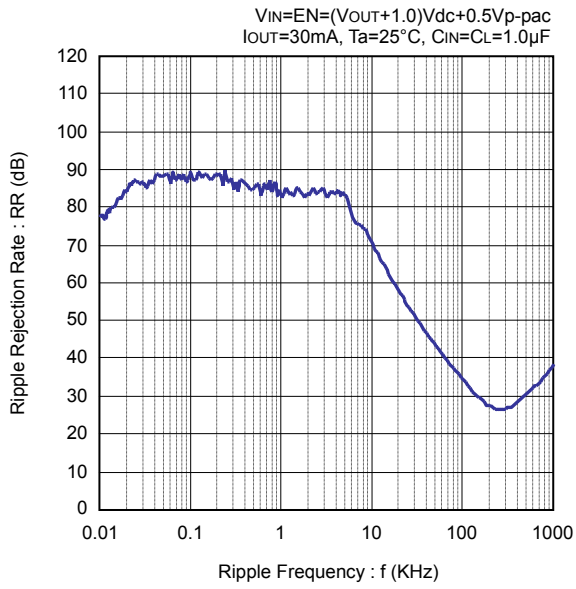

● VRD (VOUT=1.8V)

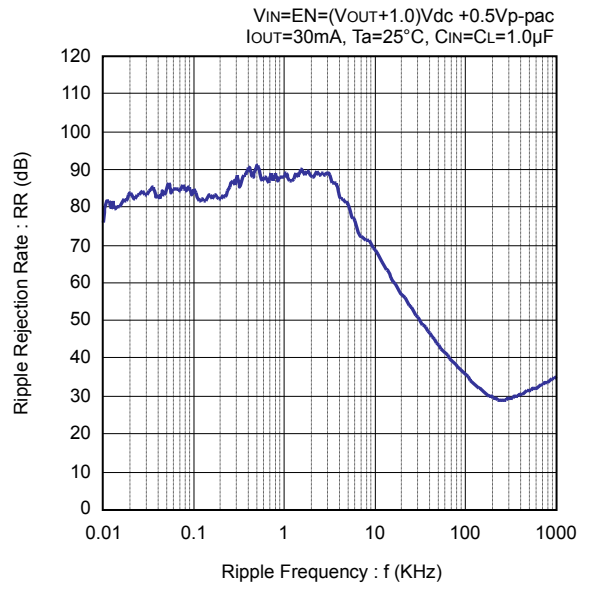

● VRD (VOUT=2.8V)

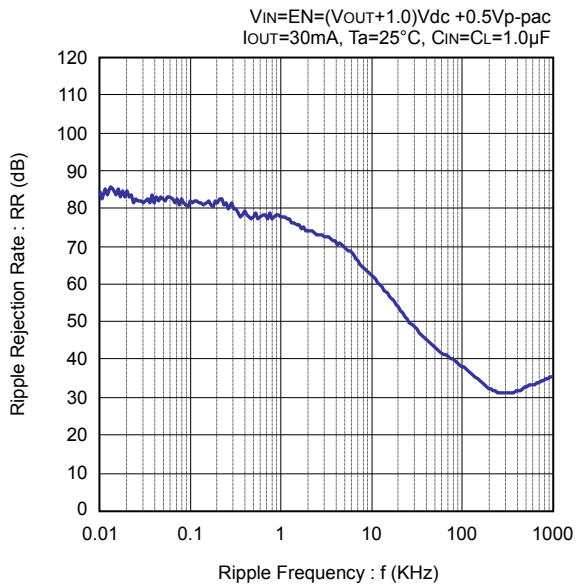

● VRD (VOUT=3.3V)

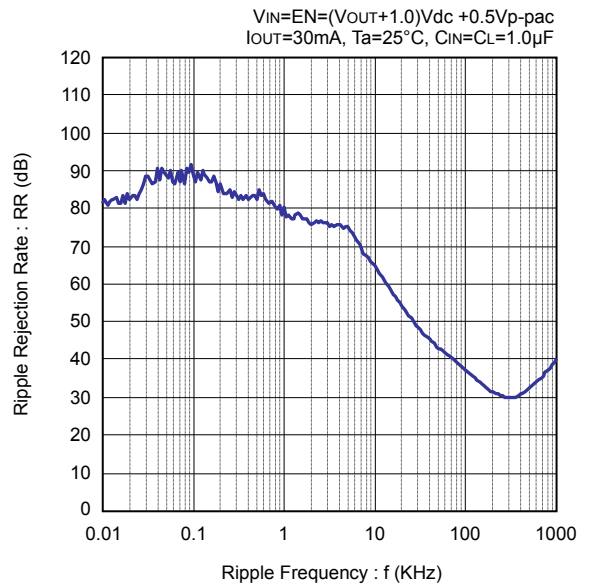

深圳市华瑞科电子有限公司

IC封装尺寸 (SOT-26)

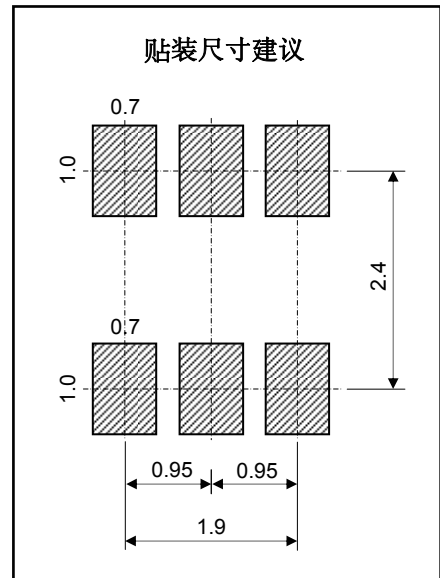
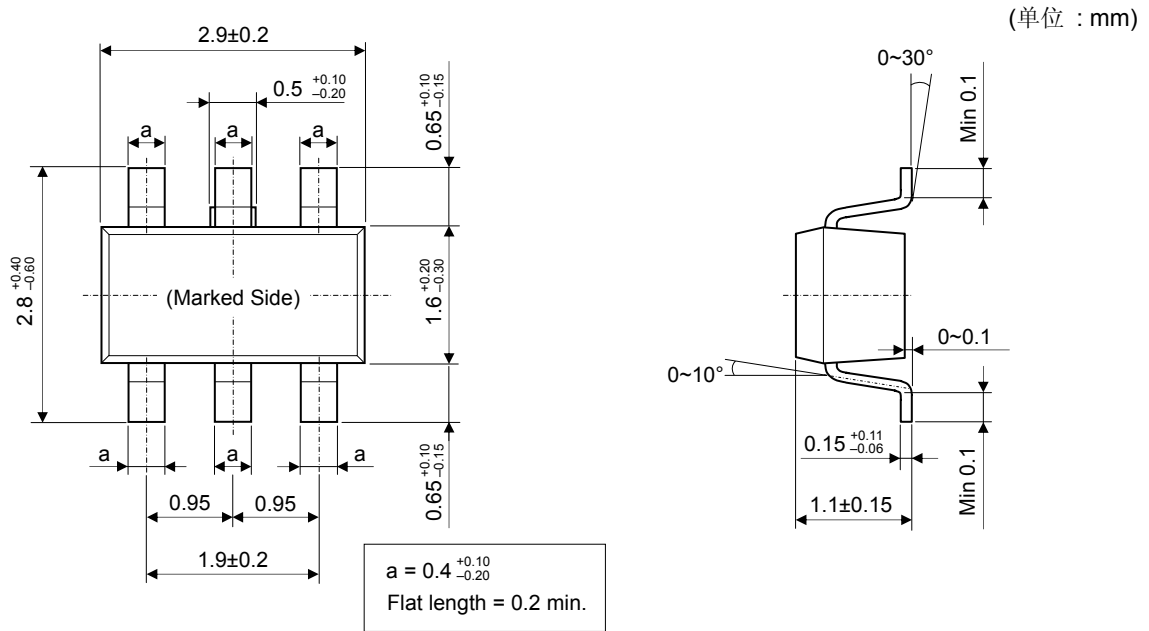

角膜贴装和IC装带规格 (SOT-26)

(单位 : mm)

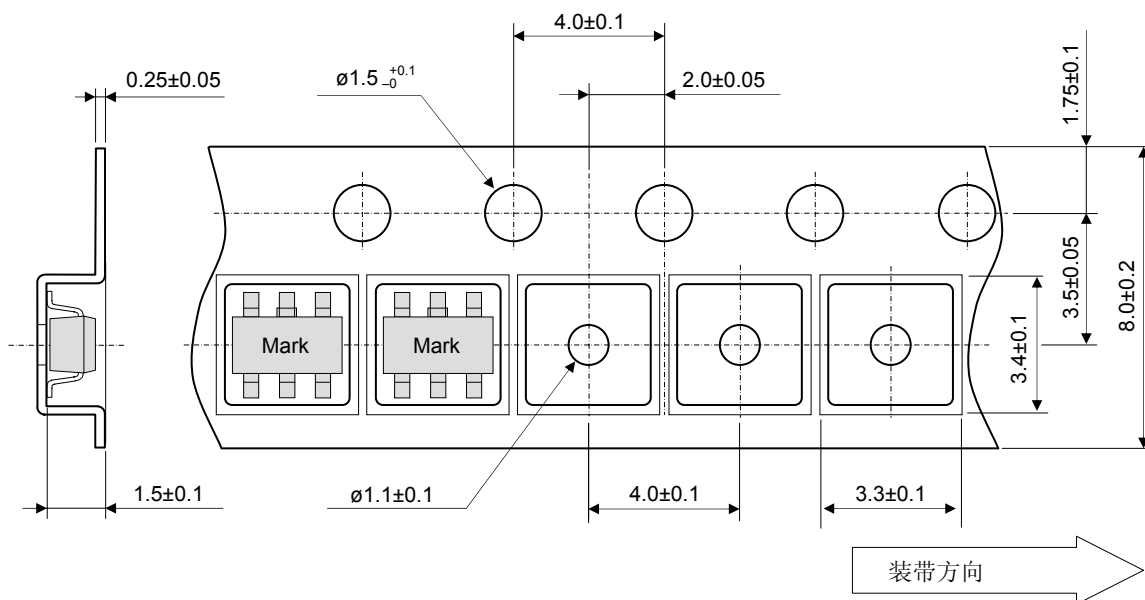

装卷尺寸 (SOT-26)

(单位 : mm)

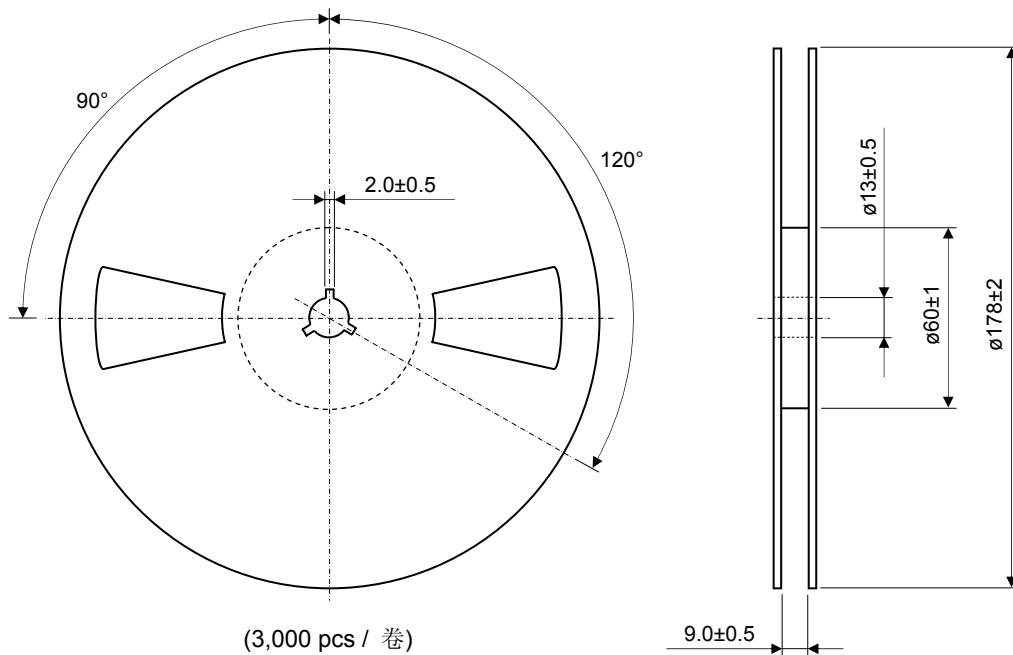

IC封装尺寸 (SON-6)

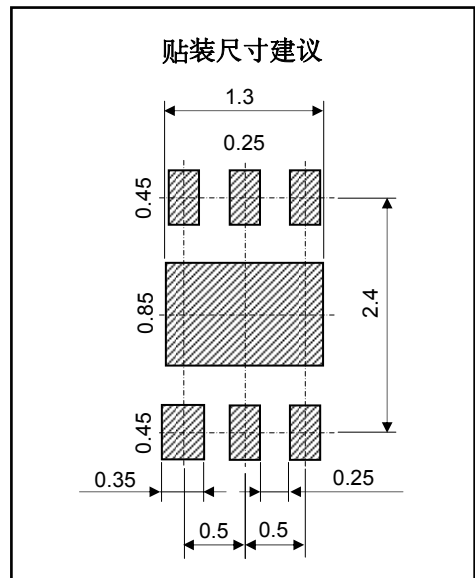
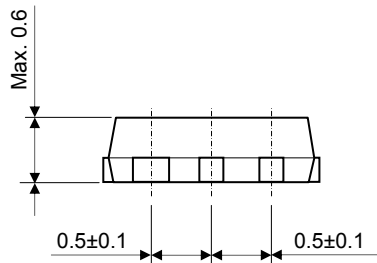
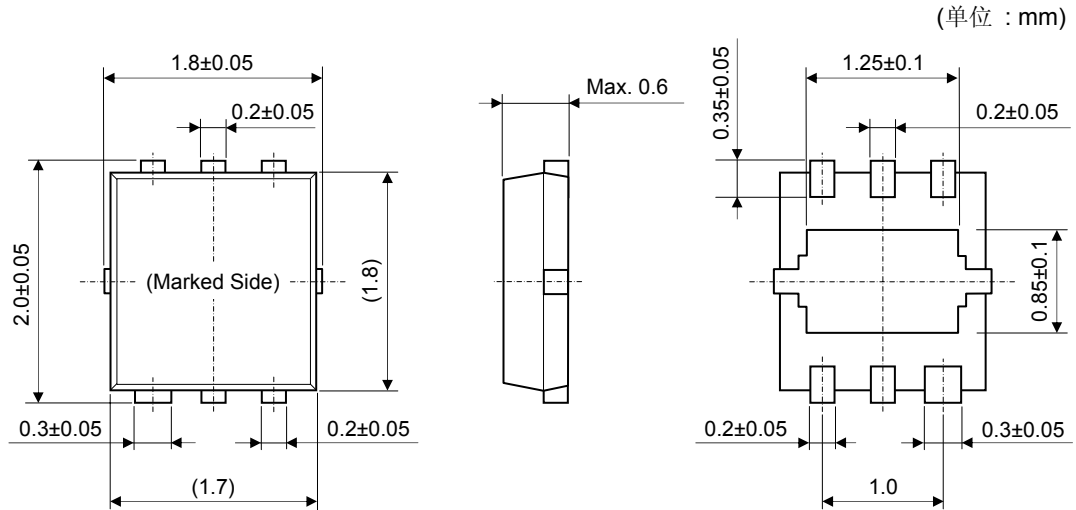

IC封装尺寸 (LLP-6)

(单位 : mm)

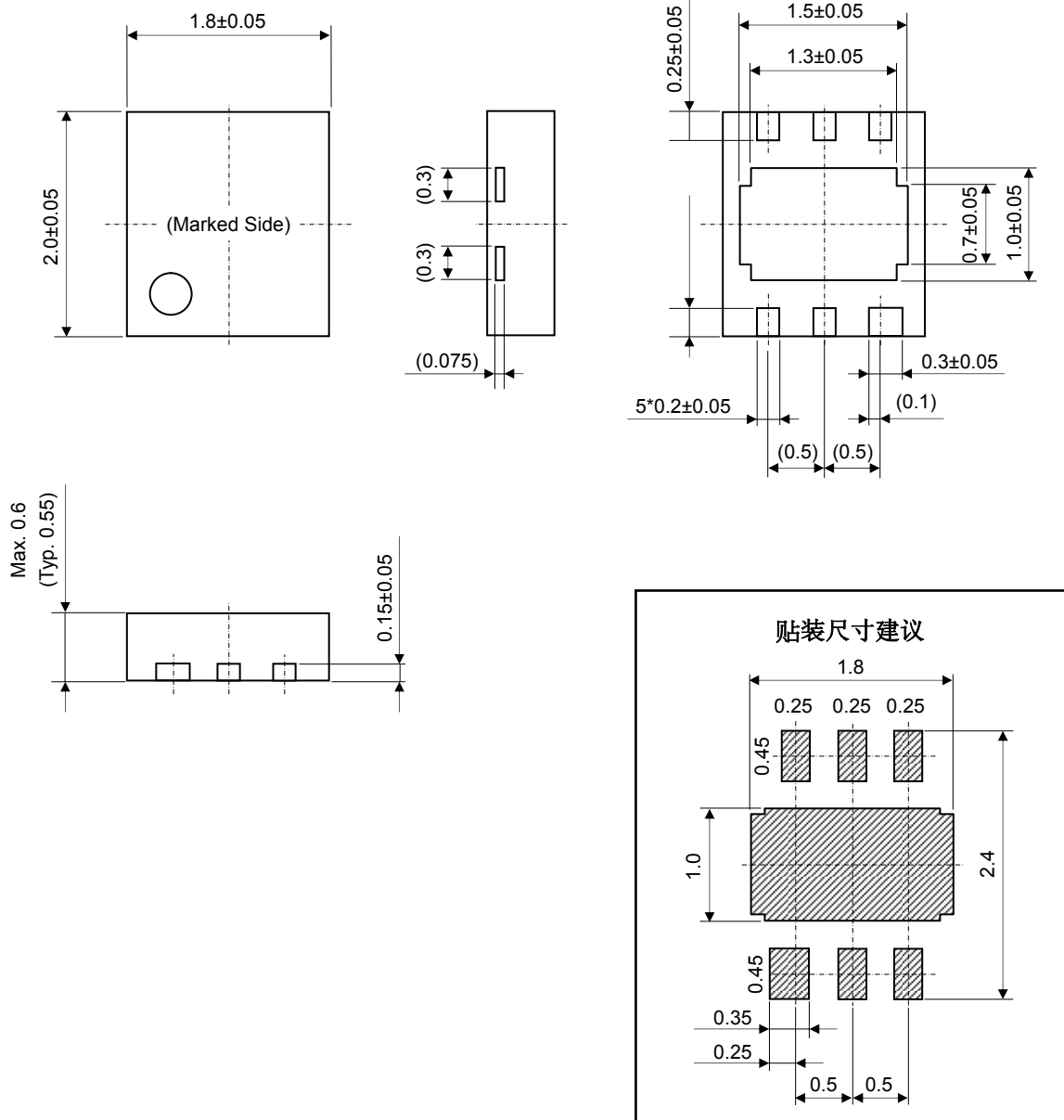

贴装尺寸建议

角膜贴装和IC装带规格 (LLP-6)

(单位 : mm)

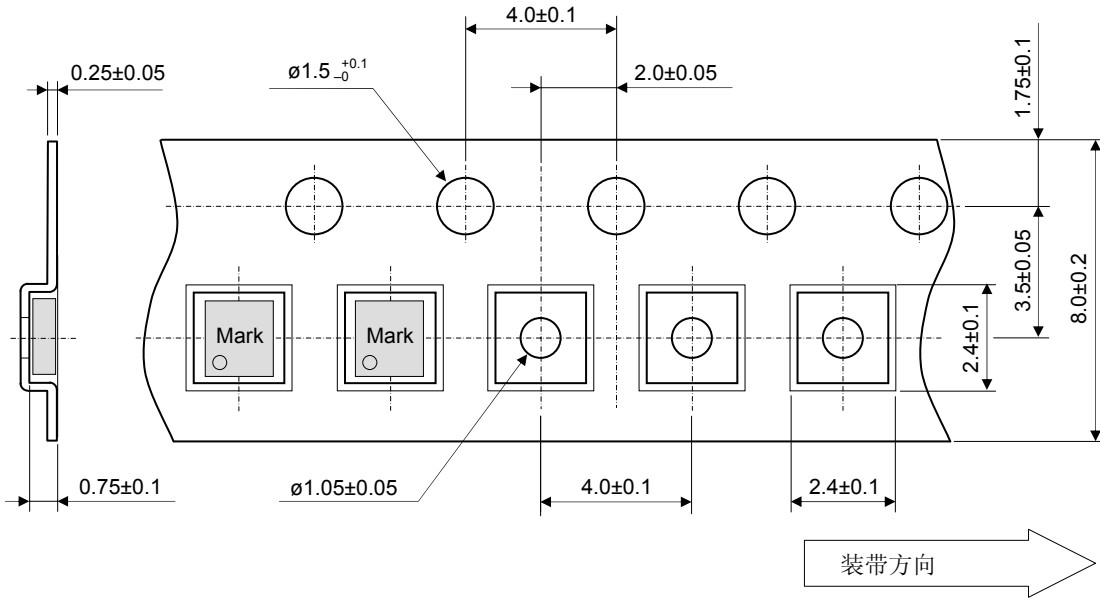

装卷尺寸 (LLP-6)

(单位 : mm)

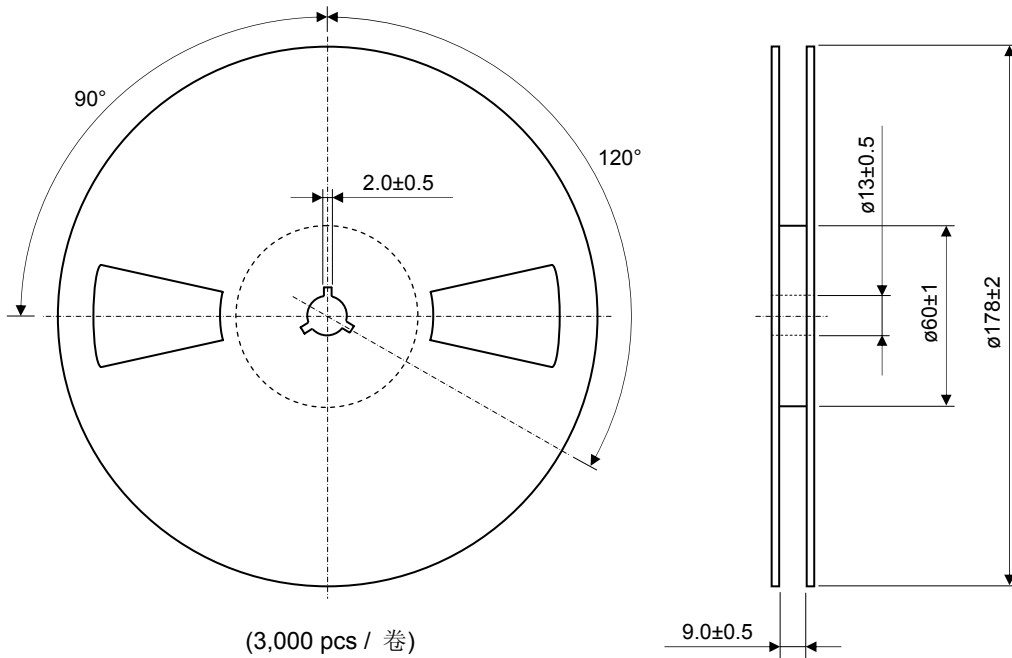

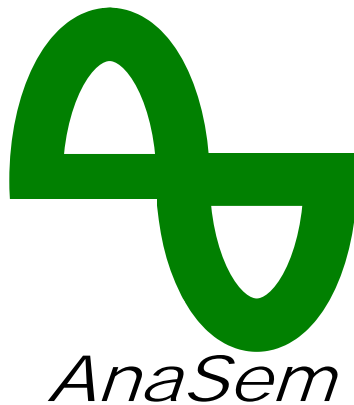

 **深圳市华瑞科电子有限公司**
HUA RUI KE
地址: 深圳市福田区海外装饰大厦A座15A35-15A36 电话: 0755-83019251 13823555393
0755-83019307 E-mail: icshi@163.com <http://www.hrkdz.hqew.com>

安纳森半导体(AnaSem Inc.)能在未作通知的情况下更改在此规格书内形容的产品, 或停产与停止提供相关之产品基于通过不断地设计和功能上的改良来为客户提供最好的产品。我们建议客户在订购安纳森产品前先与核准的销售代理核查最新的资料与更新的产品情报来确保所订购之产品为最新的版本。了解和参照规格书内的指定用法和规格是必要的。此规格书内所形容和提及之产品并不是用于对人体健康或生命做成影响的产品之意向。安纳森半导体(AnaSem Inc.)在此声明不负任何有关客户所设计的产品方案, 产品设计, 软件功能表现, 侵犯专利或服务等项目。安纳森半导体(AnaSem Inc.)并不透露或示意授权基于专利, 复制权力, 电路位置牌照, 或其他智力财产相关于安纳森在产品 and 附上所采用的配套方式和材料, 或覆盖应用方式等的保证; 也不保证在没有正式认同或没有持安纳森半导体(AnaSem Inc.)的代理证之渠道所购买的产品之功能, 质量等规格。客户不应在没有合当的政府部门批准或容许下出口(直接或间接)安纳森之产品。

ANASEM INC.
