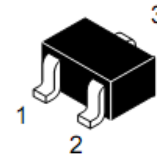
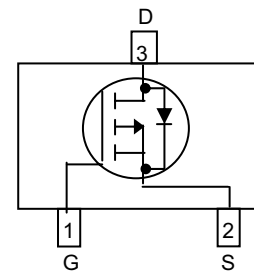

**WPM2015**
**Single P-Channel, -20V, -2.4A, Power MOSFET**
[Http://www.sh-willsemi.com](http://www.sh-willsemi.com)

$V_{DS}$ (V)	$R_{ds(on)}$ ( $\Omega$ )
-20	0.081@ $V_{GS}=-4.5V$
	0.103@ $V_{GS}=-2.5V$

**Descriptions**

The WPM2015 is P-Channel enhancement MOS Field Effect Transistor. Uses advanced trench technology and design to provide excellent  $R_{DS(ON)}$  with low gate charge. This device is suitable for use in DC-DC conversion, power switch and charging circuit. Standard Product WPM2015 is Pb-free and Halogen-free.

**SOT-23**

**Pin configuration (Top view)**
**Features**

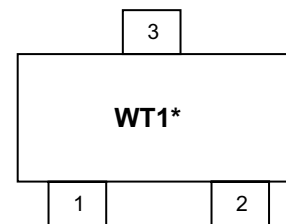
- Trench Technology
- Supper high density cell design
- Excellent ON resistance for higher DC current
- Extremely Low Threshold Voltage
- Small package SOT-23



WT1= Device Code  
\* = Month (A~Z)

**Marking**
**Applications**

- Driver for Relay, Solenoid, Motor, LED etc.
- DC-DC converter circuit
- Power Switch
- Load Switch
- Charging

**Order information**

Device	Package	Shipping
WPM2015-3/TR	SOT-23	3000/Reel&Tape

**Absolute Maximum ratings**

Parameter		Symbol	10 S	Steady State	Unit
Drain-Source Voltage		$V_{DS}$	-20		V
Gate-Source Voltage		$V_{GS}$	$\pm 8$		
Continuous Drain Current <sup>a</sup>	$T_A=25^\circ\text{C}$	$I_D$	-2.4	-2.2	A
	$T_A=70^\circ\text{C}$		-1.9	-1.7	
Maximum Power Dissipation <sup>a</sup>	$T_A=25^\circ\text{C}$	$P_D$	0.9	0.8	W
	$T_A=70^\circ\text{C}$		0.5	0.5	
Continuous Drain Current <sup>b</sup>	$T_A=25^\circ\text{C}$	$I_D$	-2.2	-2.0	A
	$T_A=70^\circ\text{C}$		-1.7	-1.6	
Maximum Power Dissipation <sup>b</sup>	$T_A=25^\circ\text{C}$	$P_D$	0.7	0.6	W
	$T_A=70^\circ\text{C}$		0.5	0.4	
Pulsed Drain Current <sup>c</sup>		$I_{DM}$	-10		A
Operating Junction Temperature		$T_J$	150		$^\circ\text{C}$
Lead Temperature		$T_L$	260		$^\circ\text{C}$
Storage Temperature Range		$T_{stg}$	-55 to 150		$^\circ\text{C}$

**Thermal resistance ratings**

Parameter		Symbol	Typical	Maximum	Unit
Junction-to-Ambient Thermal Resistance <sup>a</sup>	$t \leq 10 \text{ s}$	$R_{\theta JA}$	105	135	$^\circ\text{C/W}$
	Steady State		120	155	
Junction-to-Ambient Thermal Resistance <sup>b</sup>	$t \leq 10 \text{ s}$	$R_{\theta JA}$	130	160	
	Steady State		145	190	
Junction-to-Case Thermal Resistance		$R_{\theta JC}$	60	75	

a Surface mounted on FR-4 Board using 1 square inch pad size, 1oz copper

b Surface mounted on FR-4 board using minimum pad size, 1oz copper

c Pulse width < 380 $\mu\text{s}$ , Duty Cycle < 2%

d Maximum junction temperature  $T_J=150^\circ\text{C}$ .

**Electronics Characteristics (Ta=25°C, unless otherwise noted)**

Parameter	Symbol	Test Conditions	Min	Typ	Max	Unit
<b>OFF CHARACTERISTICS</b>						
Drain-to-Source Breakdown Voltage	$BV_{DSS}$	$V_{GS} = 0\text{ V}, I_D = -250\mu\text{A}$	-20			V
Zero Gate Voltage Drain Current	$I_{DSS}$	$V_{DS} = -16\text{ V}, V_{GS} = 0\text{ V}$			-1	$\mu\text{A}$
Gate-to-source Leakage Current	$I_{GSS}$	$V_{DS} = 0\text{ V}, V_{GS} = \pm 8\text{ V}$			$\pm 100$	nA
<b>ON CHARACTERISTICS</b>						
Gate Threshold Voltage	$V_{GS(TH)}$	$V_{GS} = V_{DS}, I_D = -250\mu\text{A}$	-0.40	-0.62	-0.81	V
Drain-to-source On-resistance <sup>b, c</sup>	$R_{DS(on)}$	$V_{GS} = -4.5\text{ V}, I_D = -2.7\text{ A}$		81	110	m $\Omega$
		$V_{GS} = -2.5\text{ V}, I_D = -2.2\text{ A}$		103	150	
<b>CAPACITANCES, CHARGES</b>						
Input Capacitance	$C_{ISS}$	$V_{GS} = 0\text{ V},$ $f = 1.0\text{ MHz},$ $V_{DS} = -10\text{ V}$		534		pF
Output Capacitance	$C_{OSS}$			62		
Reverse Transfer Capacitance	$C_{RSS}$			54		
Total Gate Charge	$Q_{G(TOT)}$	$V_{GS} = -4.5\text{ V},$ $V_{DS} = -10\text{ V},$ $I_D = -2.7\text{ A}$		7.3		nC
Threshold Gate Charge	$Q_{G(TH)}$			0.5		
Gate-to-Source Charge	$Q_{GS}$			1.25		
Gate-to-Drain Charge	$Q_{GD}$			1.15		
<b>SWITCHING CHARACTERISTICS</b>						
Turn-On Delay Time	$t_d(ON)$	$V_{GS} = -4.5\text{ V},$ $V_{DS} = -10\text{ V},$ $I_D = -1.2\text{ A},$ $R_G = 6\ \Omega$		8.0		ns
Rise Time	$t_r$			6.4		
Turn-Off Delay Time	$t_d(OFF)$			41.0		
Fall Time	$t_f$			7.0		
<b>BODY DIODE CHARACTERISTICS</b>						
Forward Voltage	$V_{SD}$	$V_{GS} = 0\text{ V}, I_S = -0.9\text{ A}$		-0.74	-1.5	V

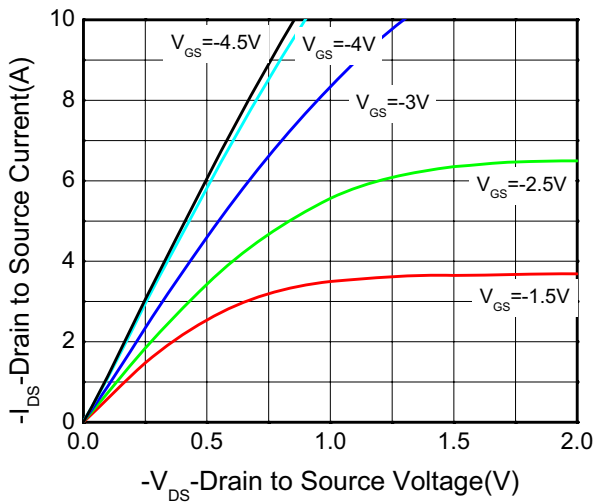
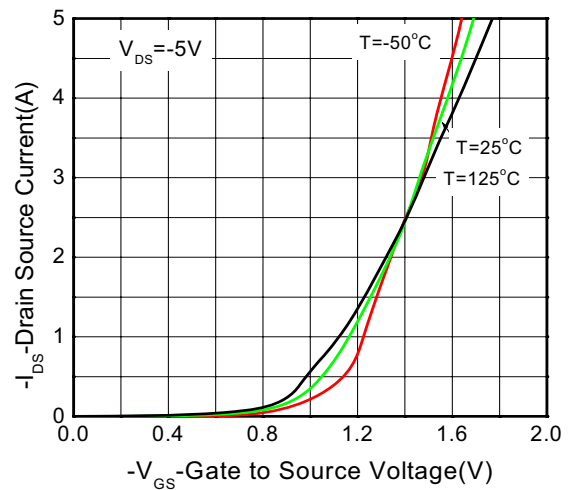
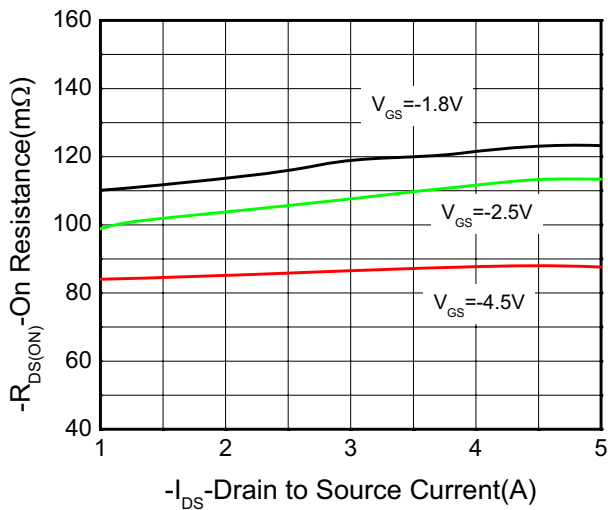
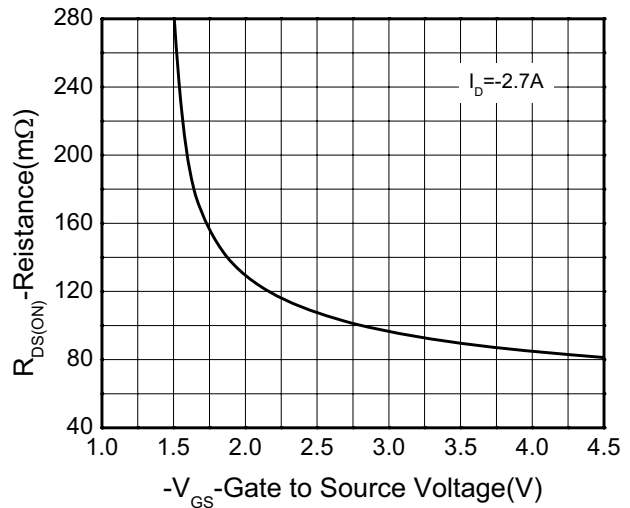
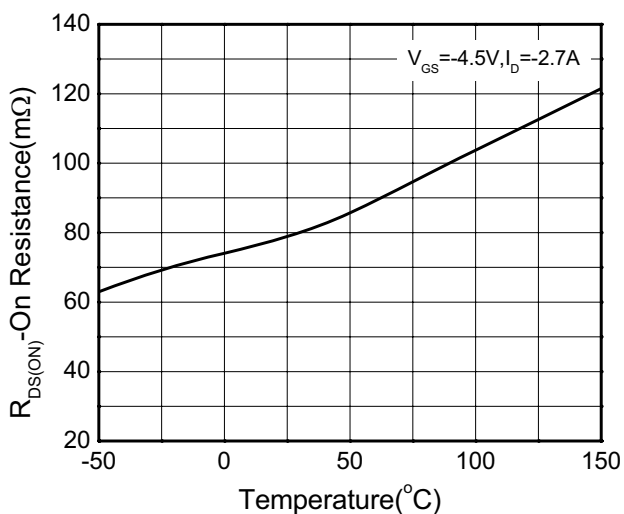
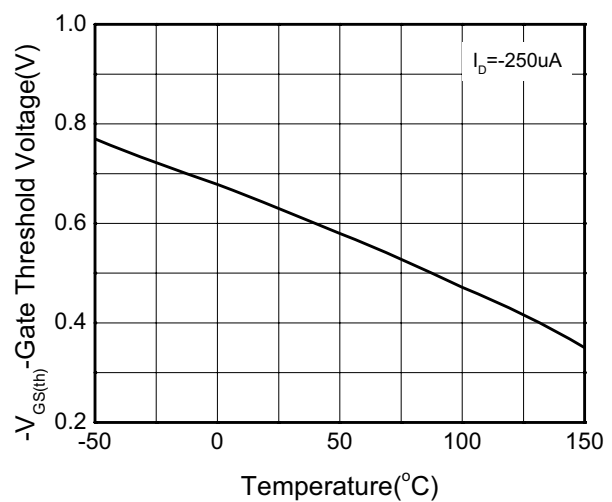
**Typical Characteristics (Ta=25°C, unless otherwise noted)**

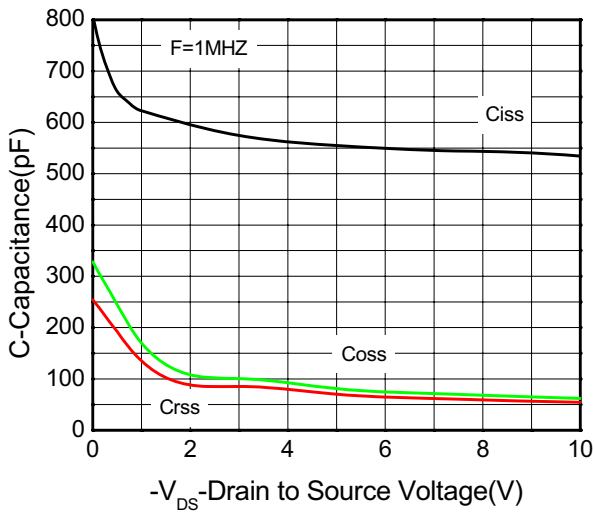
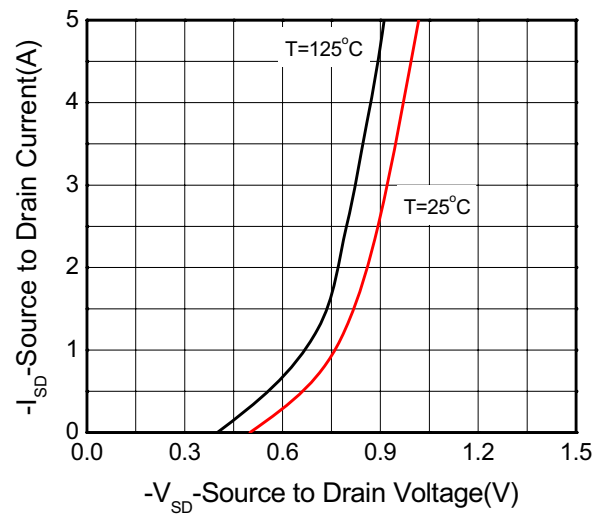
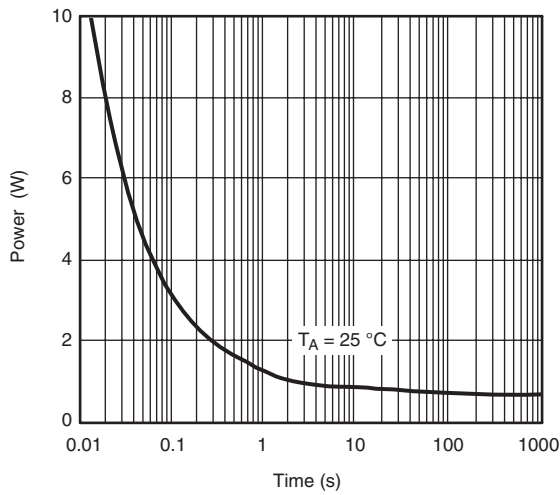
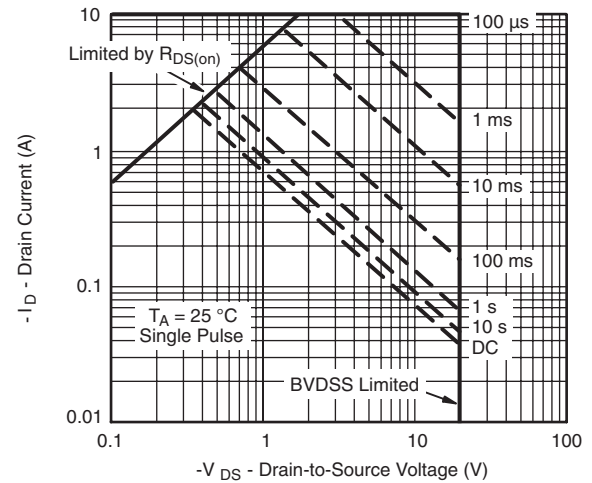
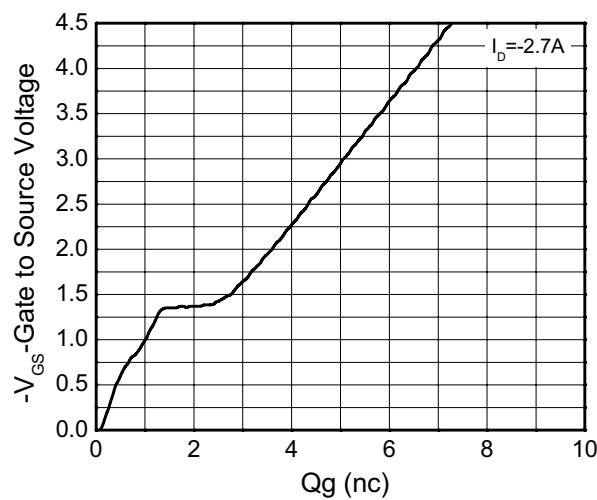
**Output characteristics**

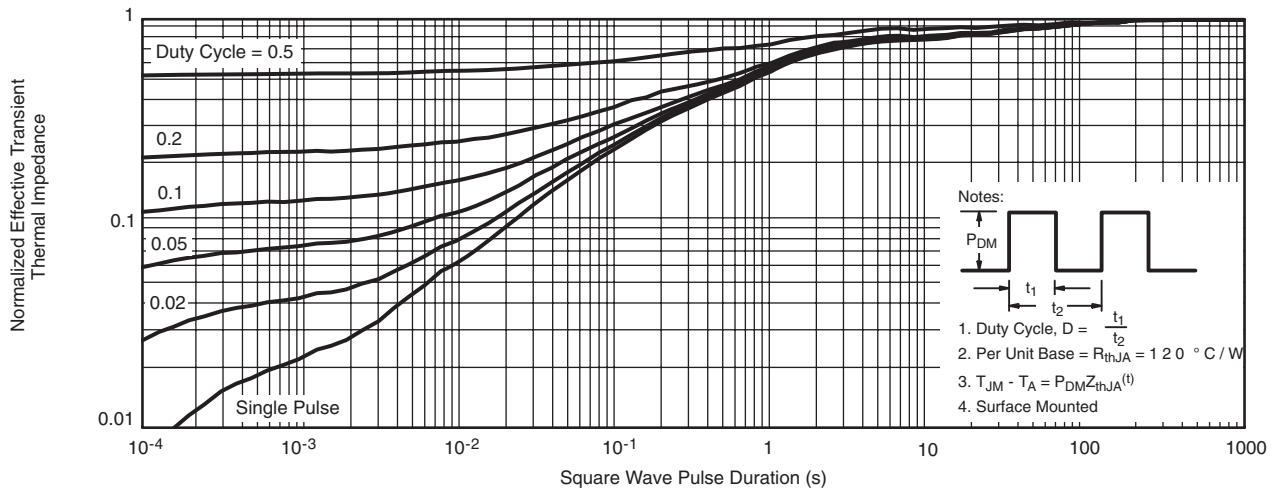
**Transfer characteristics**

**On-Resistance vs. Drain current**

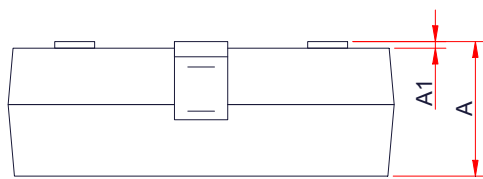
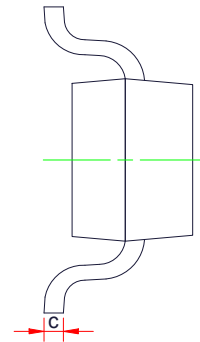
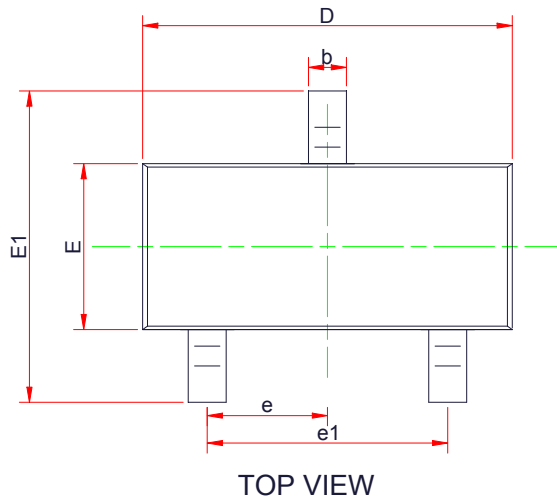
**On-Resistance vs. Gate-to-Source voltage**

**On-Resistance vs. Junction temperature**

**Threshold voltage vs. Temperature**



**Capacitance**

**Body diode forward voltage**

**Single pulse power**

**Safe operating power**

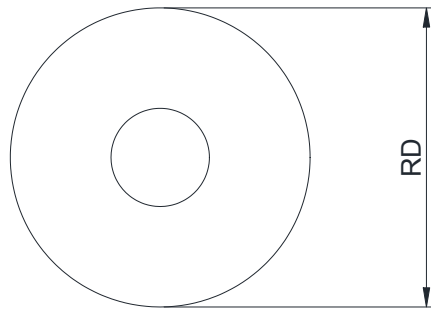
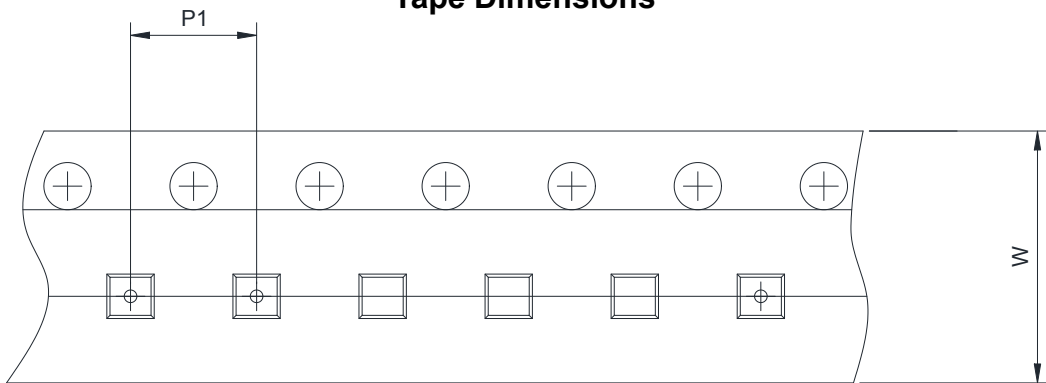
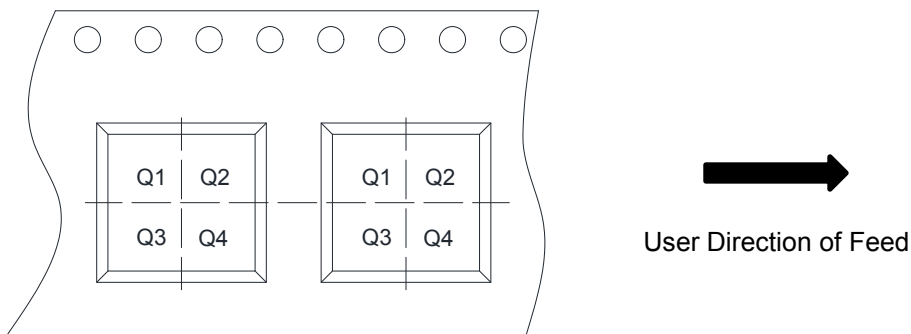
**Gate Charge Characteristics**



**Transient thermal response (Junction-to-Ambient)**

**Package outline dimensions**
**SOT-23**

**SIDE VIEW**

Symbol	Dimensions in Millimeters		
	Min.	Typ.	Max.
A	0.89	1.10	1.30
A1	0.00	-	0.10
b	0.30	0.43	0.55
c	0.05	-	0.20
D	2.70	2.90	3.10
E	1.15	1.33	1.50
E1	2.10	2.40	2.70
e	0.95 Typ.		
e1	1.70	1.90	2.10

**TAPE AND REEL INFORMATION**
**Reel Dimensions**

**Tape Dimensions**

**Quadrant Assignments For PIN1 Orientation In Tape**

RD	Reel Dimension	<input checked="" type="checkbox"/> 7inch	<input type="checkbox"/> 13inch
W	Overall width of the carrier tape	<input checked="" type="checkbox"/> 8mm	<input type="checkbox"/> 12mm <input type="checkbox"/> 16mm
P1	Pitch between successive cavity centers	<input type="checkbox"/> 2mm	<input checked="" type="checkbox"/> 4mm <input type="checkbox"/> 8mm
Pin1	Pin1 Quadrant	<input type="checkbox"/> Q1	<input type="checkbox"/> Q2 <input checked="" type="checkbox"/> Q3 <input type="checkbox"/> Q4