

# APPROVAL SHEET

**WW25C**

**±5%, ±1%**

Thick Film Power Low Ohm Chip Resistors

Size 2512, 1W

\*Contents in this sheet are subject to change without prior notice.

## FEATURE

1. High power rating and low range
2. High reliability and stability
3. Suitable for current sensing of small mobile devices
4. RoHS compliant & Lead free
5. Up side down mounting to minimize resistance drift after soldering

## APPLICATION

- Game equipment
- Mobile phone
- Battery pack
- Power supply
- DSC
- HDD

## DESCRIPTION

The resistors are constructed in a high grade ceramic body (aluminum oxide). Internal metal electrodes are added at each end and connected by a resistive paste that is applied to the top surface of the substrate. The composition of the paste is adjusted to give the approximate resistance required and the value is trimmed to nominated value within tolerance which controlled by laser trimming of this resistive layer.

The resistive layer is covered with a protective coat. Finally, the two external end terminations are added. For ease of soldering the outer layer of these end terminations is a Tin (lead free) alloy.



Fig 1. Construction of Chip-R

**QUICK REFERENCE DATA**

| Item                                       | General Specification        |
|--|------------------------------|
| Series No.                                 | WW25C                        |
| Size code                                  | 2512 ( 6332 )                |
| Resistance Tolerance                       | ±5%, ±1%                     |
| Resistance Range                           | 0.020Ω ~ 0.100Ω ( E24 +E96 ) |
| TCR (ppm/°C)<br>0.020Ω ~ 0.100Ω            | ±100 ppm                     |
| Max. dissipation at T <sub>amb</sub> =70°C | 1 W                          |
| Max. Operation Current (DC or RMS)         | 3.1A ~ 7 A                   |
| Operation temperature                      | -55 ~ +125°C                 |

Note :

- This is the maximum current that may be continuously supplied to the resistor element, see "IEC publication 60115-8"
- Max. Operation current : So called RCWC (Rated Continuous Working Current) is determined by  

$$RCWC = \sqrt{\text{Rated Power} / \text{Resistance Value}}$$

**MECHANICAL DATA(unit: mm)**

| Symbol | WW25C       |
|--------|-------------|
| L      | 6.30 ± 0.20 |
| W      | 3.20 ± 0.15 |
| H      | 0.60 ± 0.15 |
| c      | 1.10 ± 0.20 |
| d      | 1.10 ± 0.20 |

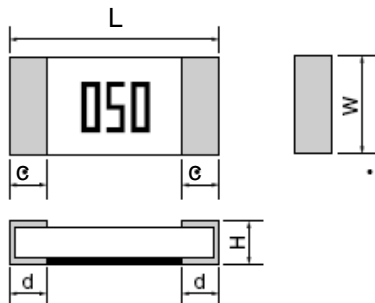

## MARKING

Each resistor is marked with a three-digit code on the substrate to designate the nominal resistance value.

Example: R10 = 0.100Ω  
050 = 0.050Ω

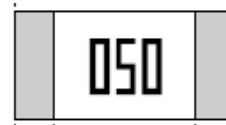

## FUNCTIONAL DESCRIPTION

### Product characterization

Standard values of nominal resistance are taken from the E96 & E24 series for resistors with a tolerance of  $\pm 5\%$  &  $\pm 1\%$ . The values of the E24/E96 series are in accordance with "IEC publication 60063".

### De-rating curve

The power that the resistor can dissipate depends on the operating temperature; see Fig.2

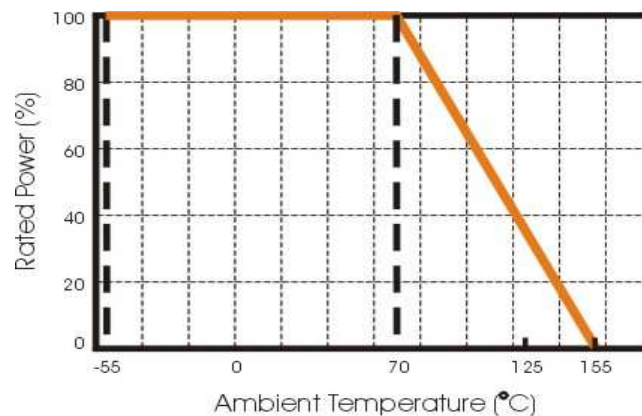

Fig.2 Maximum dissipation in percentage of rated power  
As a function of the ambient temperature

## MOUNTING

Due to their rectangular shapes and small tolerances, Surface Mountable Resistors are suitable for handling by automatic placement systems.

Chip placement can be on ceramic substrates and printed-circuit boards (PCBs).

Electrical connection to the circuit is by individual soldering condition.

The end terminations guarantee a reliable contact.

Resistive layer is on the bottom side as below !

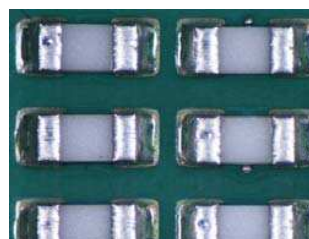
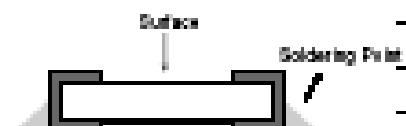

### SOLDERING CONDITION

The robust construction of chip resistors allows them to be completely immersed in a solder bath of 260°C for 10 seconds. Therefore, it is possible to mount Surface Mount Resistors on one side of a PCB and other discrete components on the reverse (mixed PCBs).

Surface Mount Resistors are tested for solderability at 235°C during 2 seconds within lead-free solder bath. The test condition for no leaching is 260°C for 30 seconds. Typical examples of soldering processes that provide reliable joints without any damage are given in Fig 3.

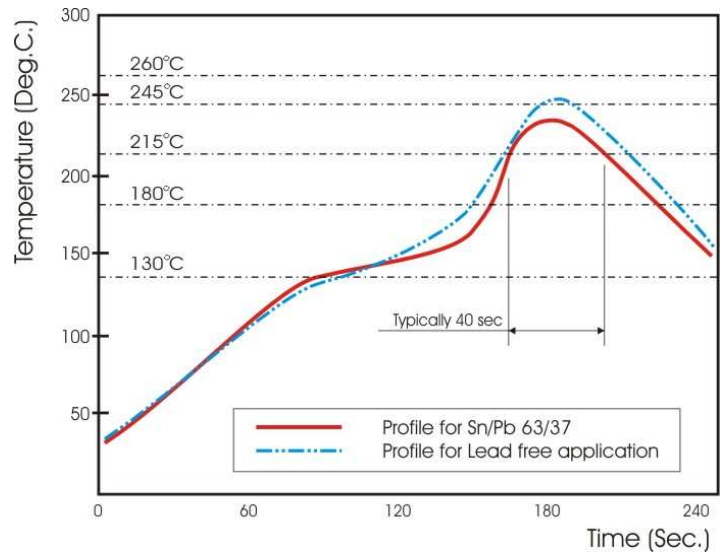

Fig 3. Infrared soldering profile for chip resistor

### CATALOGUE NUMBERS

The resistors have a catalogue number starting with .

| WW25                            | C                            | R050   | F                                      | T   | L  |
|---------------------------------|------------------------------|--|--|---|--|
| <b>Size code</b><br>WW25 : 2512 | <b>Type code</b><br>2512, 1W | <b>Resistance code</b><br>E96 +E24:<br>R is first digit followed by 3 significant digits.<br>0.020Ω = R020<br>0.100Ω = R100<br>0.025Ω = R025 | <b>Tolerance</b><br>J : ±5%<br>F : ±1% | <b>Packaging code</b><br>T : 7" Reel taping | <b>Termination code</b><br>L = Sn base (lead free) |

- Reeled tape packaging      WW25C: 12mm width embossed taping , 4,000pcs per reel.

## TEST AND REQUIREMENTS

| TEST  | PROCEDURE  | REQUIREMENT  |
|---|--|--|
| Temperature Coefficient of Resistance ( TCR )   | Natural resistance change per change in degree centigrade.<br>$\frac{R_2 - R_1}{R_1(t_2 - t_1)} \times 10^6 \text{ (ppm/}^\circ\text{C)}$ R <sub>1</sub> : Resistance at reference temperature<br>R <sub>2</sub> : Resistance at test temperature<br>t <sub>1</sub> : 25°C<br>t <sub>2</sub> : 125°C | Test temperature -55 ~ +125°C<br>As defined in P.3 |
| Short time overload ( STOL )<br>Sub-clause 4.13 | Permanent resistance change after 2 second application of a current 2.5 times RCWC specified.  | ΔR/R max. ±1%<br>no visible damage                 |
| Resistance to soldering heat<br>Sub-clause 4.18 | Unmounted chips 10±0.5 seconds, 260±5°C  | no visible damage<br>Δ R/R max. ±1%                |
| Solderability<br>Sub-clause 4.17                | Termination Sn base (lead free) : Unmounted chip completely immersed in a lead free solder bath, 235°C±5°C, 2±0.5 sec  | good tinning (>95% covered)<br>no visible damage   |
| Temperature cycling<br>Sub-clause 4.19          | 1. 30 minutes at -55°C±3°C,<br>2. 2~3 minutes at room temperature,<br>3. 30 minutes at +125°C±3°C,<br>4. 2~3 minutes at room temperature,<br>Total 5 continuous cycles   | no visible damage<br>ΔR/R max. ±1%                 |
| Load life (endurance)<br>Sub-clause 4.25.1      | 70±2°C, 1000 hours, loaded with rated current, 1.5 hours on and 0.5 hours off  | ΔR/R max. ±5%<br>no visible damage                 |
| Steady state in Humidity<br>sub-clause 4.24     | 1000hrs without current applied in humidity chamber controller at 40°C±2°C and 90~95% relative humidity  | ΔR/R max. ±5%<br>no visible damage                 |
| Bending strength<br>Sub-clause 4.33             | Resistors mounted on a 90mm glass epoxy resin PCB(FR4); bending : 1 mm, once for 10 seconds  | ΔR/R max. ±1%<br>no visible damage                 |
| Adhesion<br>Sub-clause 4.32                     | Clause 4.32 5N, 10s  | No visible damage                                  |
| High temperature exposure<br>Sub-clause 4.25.3  | 125°C no load, 1000hrs   | No visible damage<br>ΔR/R max. ±5%                 |

**PACKAGING**

Paper Tape specifications (unit :mm)

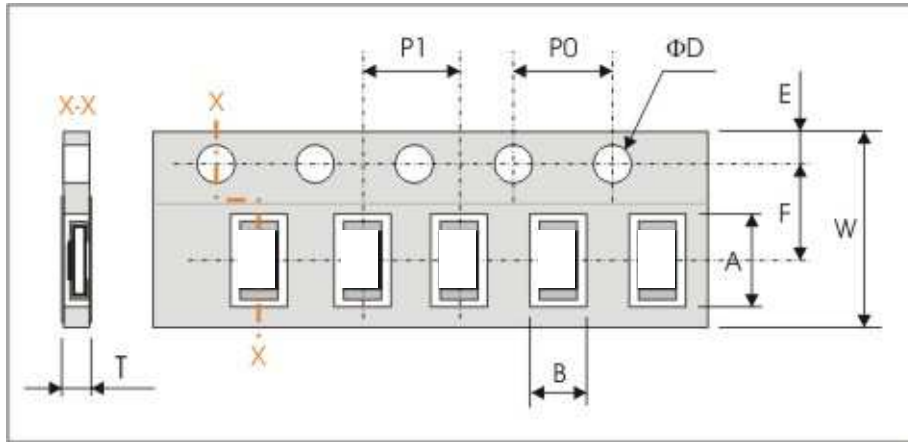

| Series No. | A         | B         | W          | F         | E         |
|------------|-----------|-----------|------------|-----------|-----------|
| WW25C      | 6.90±0.20 | 3.60±0.20 | 12.00±0.30 | 5.50±0.10 | 1.75±0.10 |

| Series No. | P1        | P0        | ΦD                                    | T         |
|------------|-----------|-----------|---------------------------------------|-----------|
| WW25C      | 4.00±0.10 | 4.00±0.10 | Φ1.50 <sup>+0.1</sup> <sub>-0.0</sub> | 1.10±0.15 |

**Reel dimensions**

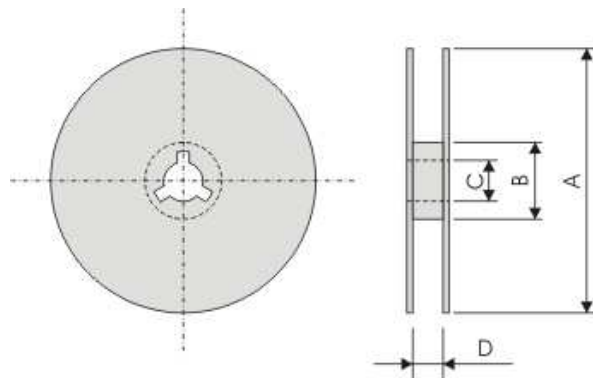

| Symbol      | A           | B         | C        | D        |
|-------------|-------------|-----------|----------|----------|
| (unit : mm) | Φ180.0 -1.5 | Φ60.0±1.0 | 13.0±0.2 | 13.0±1.0 |