

# SMF05C, SMF12C, SMF15C, SMF24C

## 5-Line Transient Voltage Suppressor Array

This 5-line voltage transient suppressor array is designed for application requiring transient voltage protection capability. It is intended for use in over-transient voltage and ESD sensitive equipment such as computers, printers, automotive electronics, networking communication and other applications. This device features a monolithic common anode design which protects five independent lines in a single SC-88 package.

### Features

- Protects up to 5-Line in a Single SC-88 Package
- Peak Power Dissipation – 100 W (8 x 20  $\mu$ s Waveform)
- ESD Rating of Class 3B (Exceeding 8 kV) per Human Body Model and Class C (Exceeding 400 V) per Machine Model.
- Compliance with IEC 61000-4-2 (ESD) 15 kV (Air), 8 kV (Contact)
- Flammability Rating of UL 94 V-0
- Pb-Free Packages are Available

### Applications

- Hand-Held Portable Applications
- Networking and Telecom
- Automotive Electronics
- Serial and Parallel Ports
- Notebooks, Desktops, Servers

### MAXIMUM RATINGS ( $T_J=25^\circ\text{C}$ unless otherwise specified)

Symbol	Rating	Value	Unit
$P_{PK}$ 1	Peak Power Dissipation 8 x 20 $\mu$ s Double Exponential Waveform (Note 1)	100	W
$T_J$	Operating Junction Temperature Range	-40 to 125	$^\circ\text{C}$
$T_{STG}$	Storage Temperature Range	-55 to 150	$^\circ\text{C}$
$T_L$	Lead Solder Temperature (10 s)	260	$^\circ\text{C}$
ESD	Human Body Model (HBM) Machine Model (MM) IEC 61000-4-2 Air (ESD) IEC 61000-4-2 Contact (ESD)	16000 400 15000 15000	V

Maximum ratings are those values beyond which device damage can occur. Maximum ratings applied to the device are individual stress limit values (not normal operating conditions) and are not valid simultaneously. If these limits are exceeded, device functional operation is not implied, damage may occur and reliability may be affected.

1. Nonrepetitive current pulse per Figure 3.



**ON Semiconductor**<sup>®</sup>

<http://onsemi.com>

## SC-88 FIVE TRANSIENT VOLTAGE SUPPRESSOR 100 W PEAK POWER

### MARKING DIAGRAM

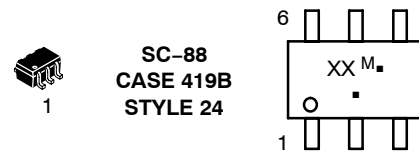

XX = Specific Device Code  
 6J = SMF05C  
 6K = SMF12C  
 6L = SMF15C  
 6M = SMF24C  
 M = Date Code  
 ■ = Pb-Free Package

### PIN ASSIGNMENT

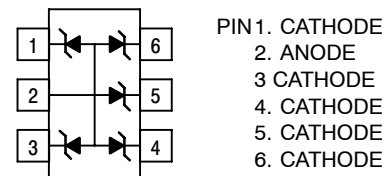

### ORDERING INFORMATION

See detailed ordering and shipping information in the package dimensions section on page 4 of this data sheet.

## SMF05C, SMF12C, SMF15C, SMF24C

### SMF05C ELECTRICAL CHARACTERISTICS ( $T_J = 25^\circ\text{C}$ unless otherwise specified)

Parameter	Symbol	Conditions	Min	Typ	Max	Unit
Reverse Working Voltage	$V_{RWM}$	(Note 2)			5.0	V
Breakdown Voltage	$V_{BR}$	$I_T = 1\text{ mA}$ , (Note 3)	6.2		7.2	V
Reverse Leakage Current	$I_R$	$V_{RWM} = 5\text{ V}$		0.07	5.0	$\mu\text{A}$
Clamping Voltage	$V_C$	$I_{PP} = 5\text{ A}$ (8 x 20 $\mu\text{s}$ Waveform)			9.8	V
Clamping Voltage	$V_C$	$I_{PP} = 8\text{ A}$ (8 x 20 $\mu\text{s}$ Waveform)			12.5	V
Maximum Peak Pulse Current	$I_{PP}$	8 x 20 $\mu\text{s}$ Waveform			8.0	A
Capacitance	$C_J$	$V_R = 0\text{ V}$ , $f = 1\text{ MHz}$ (Line to GND)		80	130	pF

### SMF12C ELECTRICAL CHARACTERISTICS ( $T_J = 25^\circ\text{C}$ unless otherwise specified)

Parameter	Symbol	Conditions	Min	Typ	Max	Unit
Reverse Working Voltage	$V_{RWM}$	(Note 2)			12	V
Breakdown Voltage	$V_{BR}$	$I_T = 1\text{ mA}$ , (Note 3)	13.3		15	V
Reverse Leakage Current	$I_R$	$V_{RWM} = 12\text{ V}$		0.01	0.1	$\mu\text{A}$
Clamping Voltage	$V_C$	$I_{PP} = 3\text{ A}$ (8 x 20 $\mu\text{s}$ Waveform)			21	V
Clamping Voltage	$V_C$	$I_{PP} = 6\text{ A}$ (8 x 20 $\mu\text{s}$ Waveform)			23	V
Maximum Peak Pulse Current	$I_{PP}$	8 x 20 $\mu\text{s}$ Waveform			6.0	A
Capacitance	$C_J$	$V_R = 0\text{ V}$ , $f = 1\text{ MHz}$ (Line to GND)		40	60	pF

### SMF15C ELECTRICAL CHARACTERISTICS ( $T_J = 25^\circ\text{C}$ , unless otherwise specified)

Parameter	Symbol	Conditions	Min	Typ	Max	Unit
Reverse Working Voltage	$V_{RWM}$	(Note 2)			15	V
Breakdown Voltage	$V_{BR}$	$I_T = 1\text{ mA}$ , (Note 3)	17		19	V
Reverse Leakage Current	$I_R$	$V_{RWM} = 15\text{ V}$		0.01	1.0	$\mu\text{A}$
Clamping Voltage	$V_C$	$I_{PP} = 1\text{ A}$ (8 x 20 $\mu\text{s}$ Waveform)			23	V
Clamping Voltage	$V_C$	$I_{PP} = 5\text{ A}$ (8 x 20 $\mu\text{s}$ Waveform)			29	V
Maximum Peak Pulse Current	$I_{PP}$	8 x 20 $\mu\text{s}$ Waveform			5.0	A
Capacitance	$C_J$	$V_R = 0\text{ V}$ , $f = 1\text{ MHz}$ (Line to GND)		33	45	pF

### SMF24C ELECTRICAL CHARACTERISTICS ( $T_J = 25^\circ\text{C}$ , unless otherwise specified)

Parameter	Symbol	Conditions	Min	Typ	Max	Unit
Reverse Working Voltage	$V_{RWM}$	(Note 2)			24	V
Breakdown Voltage	$V_{BR}$	$I_T = 1\text{ mA}$ , (Note 3)	26.7		32	V
Reverse Leakage Current	$I_R$	$V_{RWM} = 24\text{ V}$		0.01	1.0	$\mu\text{A}$
Clamping Voltage	$V_C$	$I_{PP} = 1\text{ A}$ (8 x 20 $\mu\text{s}$ Waveform)			40	V
Clamping Voltage	$V_C$	$I_{PP} = 2.5\text{ A}$ (8 x 20 $\mu\text{s}$ Waveform)			44	V
Maximum Peak Pulse Current	$I_{PP}$	8 x 20 $\mu\text{s}$ Waveform			2.5	A
Capacitance	$C_J$	$V_R = 0\text{ V}$ , $f = 1\text{ MHz}$ (Line to GND)		21	25	pF

2. TVS devices are normally selected according to the working peak reverse voltage ( $V_{RWM}$ ), which should be equal or greater than the DC or continuous peak operating voltage level.

3.  $V_{BR}$  is measured at pulse test current  $I_T$ .

# SMF05C, SMF12C, SMF15C, SMF24C

## TYPICAL PERFORMANCE CURVES

( $T_J = 25^\circ\text{C}$  unless otherwise specified)

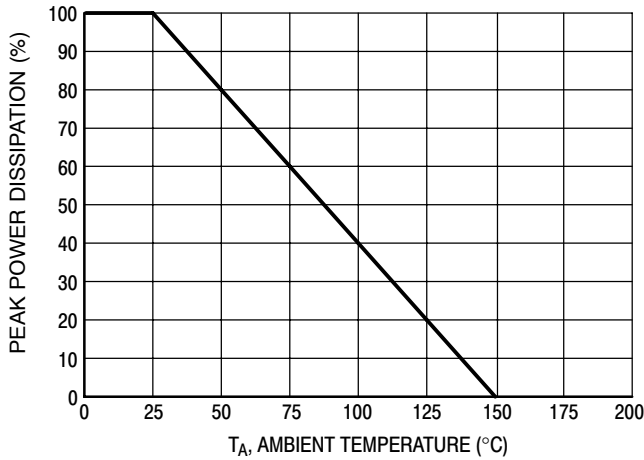

Figure 1. Pulse Derating Curve

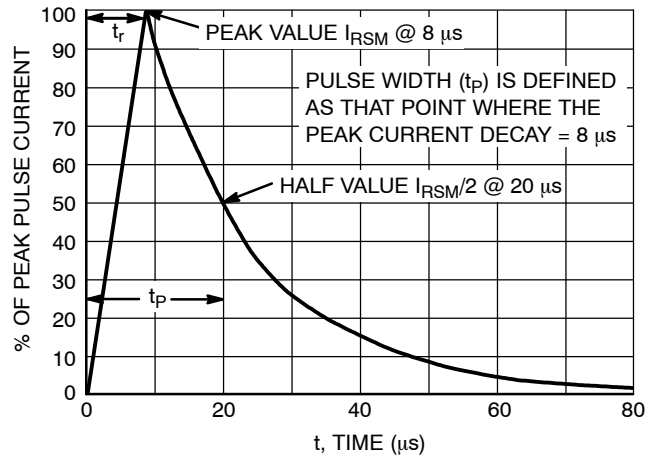

Figure 2.  $8 \times 20 \mu\text{s}$  Pulse Waveform

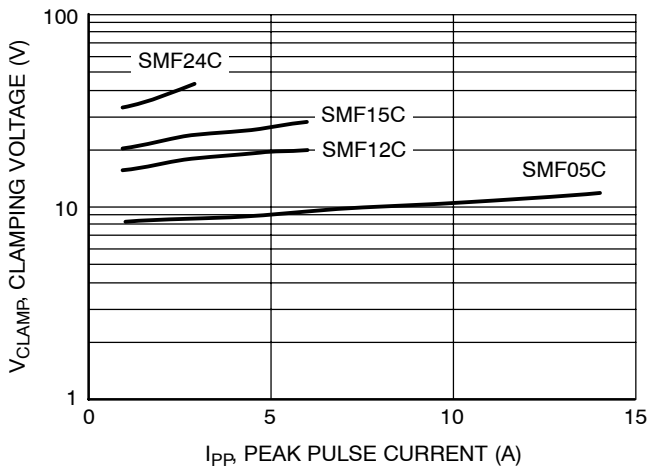

Figure 3. Clamping Voltage vs Peak Pulse Current

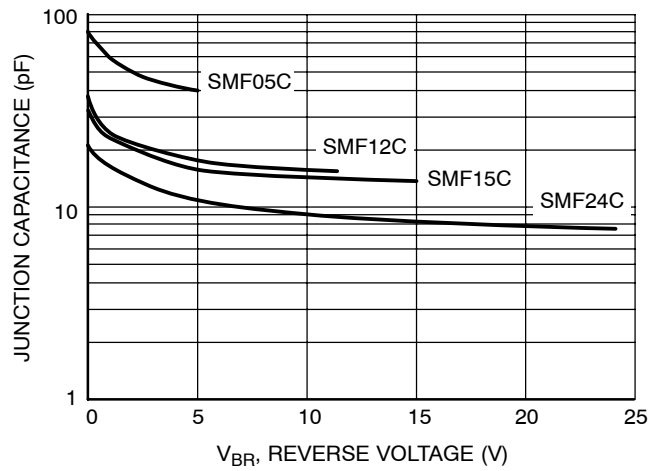

Figure 4. Junction Capacitance vs Reverse Voltage

## SMF05C, SMF12C, SMF15C, SMF24C

### ORDERING INFORMATION

Device	Package	Shipping†
SMF05CT1	SC-88	3000 / Tape & Reel
SMF05CT1G	SC-88 (Pb-Free)	3000 / Tape & Reel
SMF05CT2*	SC-88	3000 / Tape & Reel
SMF05CT2G*	SC-88 (Pb-Free)	3000 / Tape & Reel
SMF12CT1	SC-88	3000 / Tape & Reel
SMF12CT1G	SC-88 (Pb-Free)	3000 / Tape & Reel
SMF15CT1	SC-88	3000 / Tape & Reel
SMF15CT1G	SC-88 (Pb-Free)	3000 / Tape & Reel
SMF24CT1	SC-88	3000 / Tape & Reel
SMF24CT1G	SC-88 (Pb-Free)	3000 / Tape & Reel

†For information on tape and reel specifications, including part orientation and tape sizes, please refer to our Tape and Reel Packaging Specifications Brochure, BRD8011/D.

\*The "T2" suffix refers to an alternate tape & reel orientation.

# SMF05C, SMF12C, SMF15C, SMF24C

## PACKAGE DIMENSIONS

SC-88/SC70-6/SOT-363  
CASE 419B-02  
ISSUE V

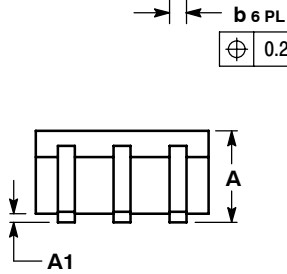
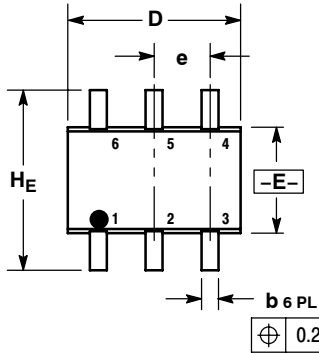

b 6 PL  
⊕ 0.2 (0.008) M E M

- NOTES:
1. DIMENSIONING AND TOLERANCING PER ANSI Y14.5M, 1982.
  2. CONTROLLING DIMENSION: INCH.
  3. 419B-01 OBSOLETE, NEW STANDARD 419B-02.

DIM	MILLIMETERS			INCHES		
	MIN	NOM	MAX	MIN	NOM	MAX
A	0.80	0.95	1.10	0.031	0.037	0.043
A1	0.00	0.05	0.10	0.000	0.002	0.004
A3	0.20 REF			0.008 REF		
b	0.10	0.21	0.30	0.004	0.008	0.012
C	0.10	0.14	0.25	0.004	0.005	0.010
D	1.80	2.00	2.20	0.070	0.078	0.086
E	1.15	1.25	1.35	0.045	0.049	0.053
e	0.65 BSC			0.026 BSC		
L	0.10	0.20	0.30	0.004	0.008	0.012
HE	2.00	2.10	2.20	0.078	0.082	0.086

- STYLE 24:  
PIN 1. CATHODE  
2. ANODE  
3. CATHODE  
4. CATHODE  
5. CATHODE  
6. CATHODE

### SOLDERING FOOTPRINT\*

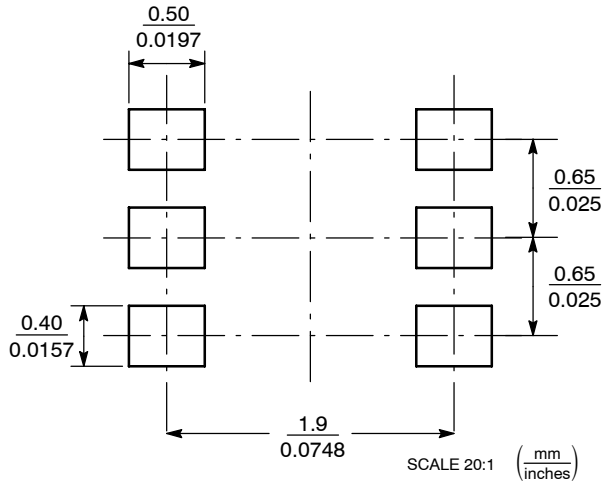

\*For additional information on our Pb-Free strategy and soldering details, please download the ON Semiconductor Soldering and Mounting Techniques Reference Manual, SOLDERRM/D.

# SMF05C, SMF12C, SMF15C, SMF24C

**ON Semiconductor** and **ON** are registered trademarks of Semiconductor Components Industries, LLC (SCILLC). SCILLC reserves the right to make changes without further notice to any products herein. SCILLC makes no warranty, representation or guarantee regarding the suitability of its products for any particular purpose, nor does SCILLC assume any liability arising out of the application or use of any product or circuit, and specifically disclaims any and all liability, including without limitation special, consequential or incidental damages. "Typical" parameters which may be provided in SCILLC data sheets and/or specifications can and do vary in different applications and actual performance may vary over time. All operating parameters, including "Typicals" must be validated for each customer application by customer's technical experts. SCILLC does not convey any license under its patent rights nor the rights of others. SCILLC products are not designed, intended, or authorized for use as components in systems intended for surgical implant into the body, or other applications intended to support or sustain life, or for any other application in which the failure of the SCILLC product could create a situation where personal injury or death may occur. Should Buyer purchase or use SCILLC products for any such unintended or unauthorized application, Buyer shall indemnify and hold SCILLC and its officers, employees, subsidiaries, affiliates, and distributors harmless against all claims, costs, damages, and expenses, and reasonable attorney fees arising out of, directly or indirectly, any claim of personal injury or death associated with such unintended or unauthorized use, even if such claim alleges that SCILLC was negligent regarding the design or manufacture of the part. SCILLC is an Equal Opportunity/Affirmative Action Employer. This literature is subject to all applicable copyright laws and is not for resale in any manner.

## PUBLICATION ORDERING INFORMATION

### LITERATURE FULFILLMENT:

Literature Distribution Center for ON Semiconductor  
P.O. Box 61312, Phoenix, Arizona 85082-1312 USA  
**Phone:** 480-829-7710 or 800-344-3860 Toll Free USA/Canada  
**Fax:** 480-829-7709 or 800-344-3867 Toll Free USA/Canada  
**Email:** [orderlit@onsemi.com](mailto:orderlit@onsemi.com)

**N. American Technical Support:** 800-282-9855 Toll Free  
USA/Canada

**Japan:** ON Semiconductor, Japan Customer Focus Center  
2-9-1 Kamimeguro, Meguro-ku, Tokyo, Japan 153-0051  
**Phone:** 81-3-5773-3850

**ON Semiconductor Website:** <http://onsemi.com>

**Order Literature:** <http://www.onsemi.com/litorder>

For additional information, please contact your  
local Sales Representative.