

Surface Mount Glass Passivated Standard Rectifier  
Reverse Voltage -50~1000 V  
Forward Current - 1.0A



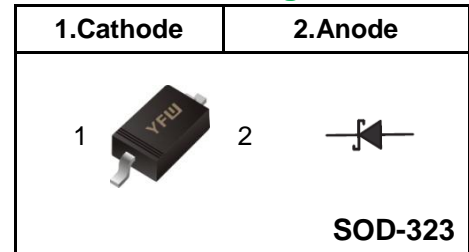
**FEATURES**

- ◆ Low Forward Voltage Drop
- ◆ Guard Ring Construction for Transient Protection
- ◆ Negligible Reverse Recovery Time
- ◆ Low Capacitance
- ◆ Lead free in comply with EU RoHS 2011/65/EU directives

**MECHANICAL DATA**

- ◆ Case: SOD-323
- ◆ Terminals: Solderable per MIL-STD-750, Method 2026
- ◆ Approx. Weight: 5.48mg /0.00019oz

**Pinning**



**Marking Code**

<b>1N4001WS</b>	<b>1A</b>
<b>1N4002WS</b>	<b>2A</b>
<b>1N4003WS</b>	<b>3A</b>
<b>1N4004WS</b>	<b>4A</b>
<b>1N4005WS</b>	<b>5A</b>
<b>1N4006WS</b>	<b>6A</b>
<b>1N4007WS</b>	<b>7A</b>

**Maximum Ratings and Electrical characteristics**

Ratings at 25 °C ambient temperature unless otherwise specified.

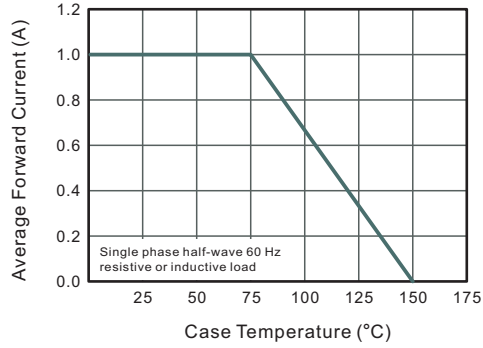
Parameter	Symbols	1N4001WS	1N4002WS	1N4003WS	1N4004WS	1N4005WS	1N4006WS	1N4007WS	Units
Peak Repetitive Reverse Voltage	$V_{RRM}$	50	100	200	400	600	800	1000	V
RMS reverse voltage	$V_{RMS}$	35	70	140	280	420	560	700	V
Working Peak Reverse Voltage	$V_{DC}$	50	100	200	400	600	800	1000	V
Maximum Average Forward Rectified Current	$I_{F(AV)}$	1							A
Peak Forward Surge Current, 8.3ms Single Half Sine-wave Superimposed On Rated Load	$I_{FSM}$	15							A
Maximum Instantaneous Forward Voltage 1A	$V_F$	1.1							v
Maximum DC Reverse Current Ta=25 °C at Rated DC Blocking Voltage Ta=125 °C	$I_R$	5 50							uA
Typical Thermal Resistance <sup>(1)</sup>	$R_{\theta JA}$	55							°C/W
Typical reverse recovery time <sup>(2)</sup>	$T_{rr}$	1.8							uS
Typical junction capacitance <sup>(3)</sup>	$C_j$	5							pF
Operating and Storage Temperature Range	$T_j, T_{stg}$	-55 ~ +150							°C

(1) P.C.B. mounted with 0.2" X 0.2" (5 X 5 mm) copper pad areas.

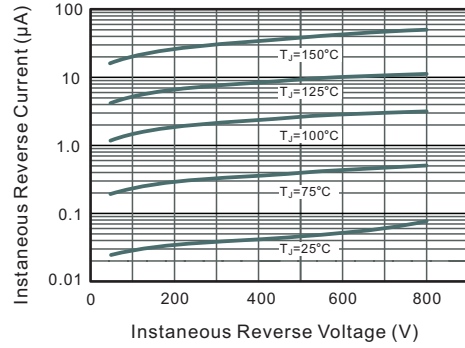
(2) Measured with  $I_F=0.5A, I_R=1A, I_{rr}=0.25A$

(3) Measured at 1 MHz and applied reverse voltage of 4 V D.C

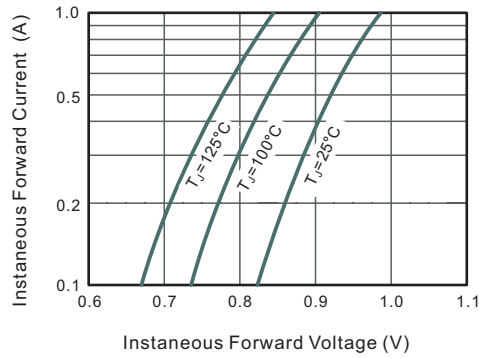
**Fig.1 Forward Current Derating Curve**



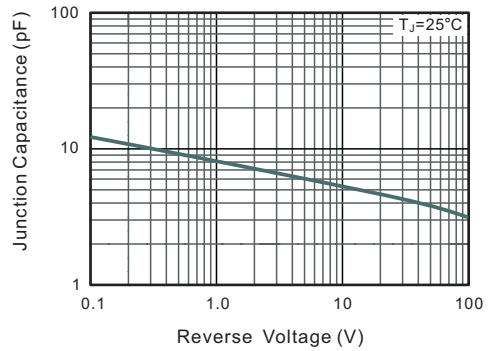
**Fig.2 Typical Instaneous Reverse Characteristics**



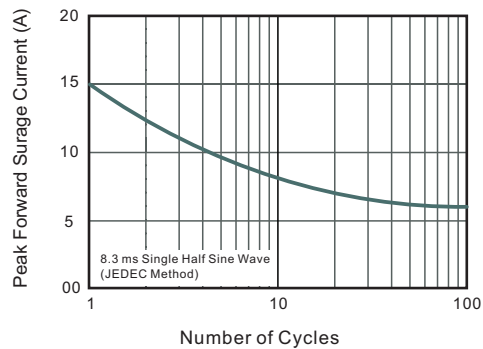
**Fig.3 Typical Forward Characteristic**



**Fig.4 Typical Junction Capacitance**

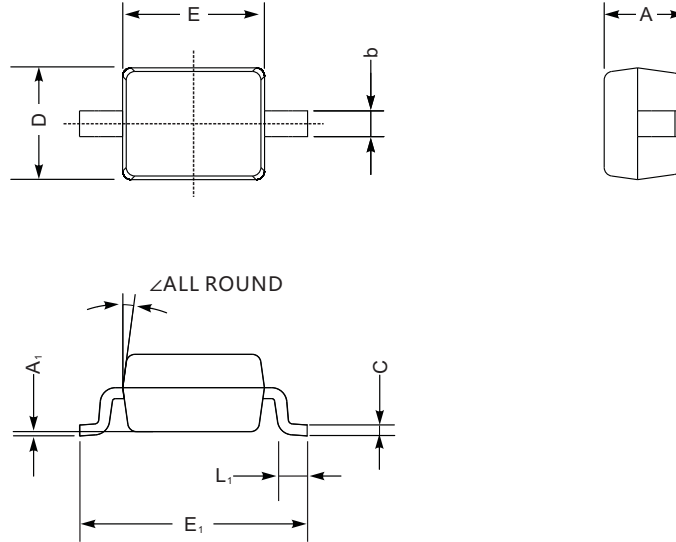


**Fig.5 Maximum Non-Repetitive Peak Forward Surage Current**



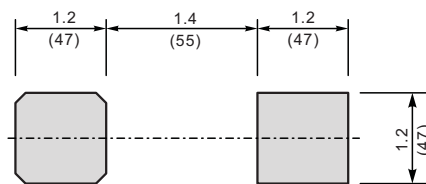
**Package Outline SOD-323**

Plastic surface mounted package; 2 leads



UNIT		A	C	D	E	E <sub>1</sub>	b	L <sub>1</sub>	A <sub>1</sub>	∠
mm	max	1.1	0.15	1.4	1.8	2.75	0.4	0.45	0.2	9°
	min	0.8	0.08	1.2	1.4	2.55	0.25	0.2	—	
mil	max	43	5.9	55	70	108	16	16	8	
	min	32	3.1	47	63	100	9.8	7.9	—	

**The recommended mounting pad size**



Unit:  $\frac{\text{mm}}{\text{mil}}$

**Summary of Packing Options**

Package	Packing Description	Packing Quantity	Industry Standard
SOD-323	Tape/Reel, 7" reel	3000	EIA-481-1