

PROCESS DETAILS

Process	EPITAXIAL PLANAR
Die Size	40 x 40 MILS
Die Thickness	9.0 MILS
Base Bonding Pad Area	7.9 x 8.7 MILS
Emitter Bonding Pad Area	9.0 x 14 MILS
Top Side Metalization	Al - 30,000Å
Back Side Metalization	Au - 18,000Å

GEOMETRY

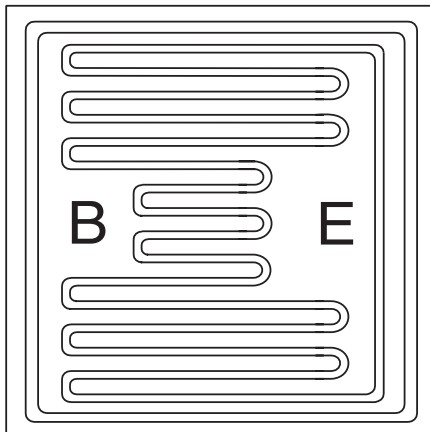

BACKSIDE COLLECTOR R0

GROSS DIE PER 4 INCH WAFER

6,936

PRINCIPAL DEVICE TYPES

CBCP68
CBCX68
CZT651
MPS650
MPS651

145 Adams Avenue
Hauppauge, NY 11788 USA
Tel: (631) 435-1110
Fax: (631) 435-1824
www.centrasemi.com

R3 (8-October 2008)

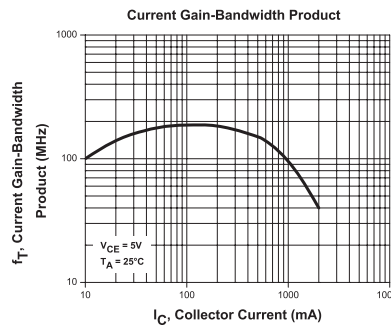
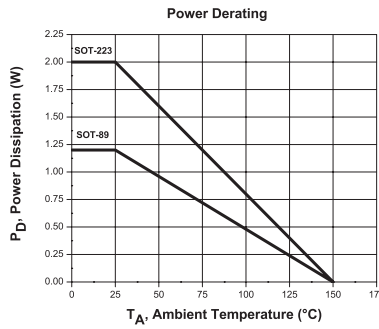
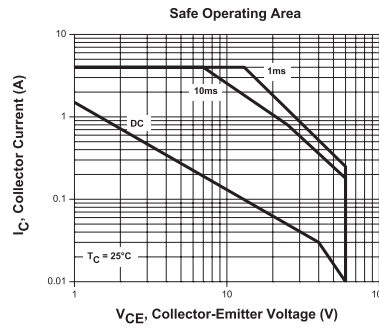
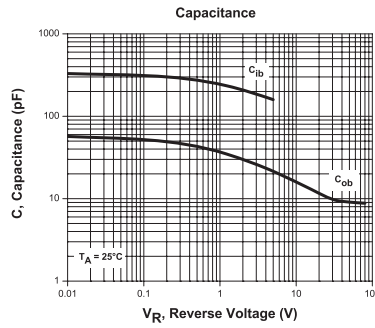
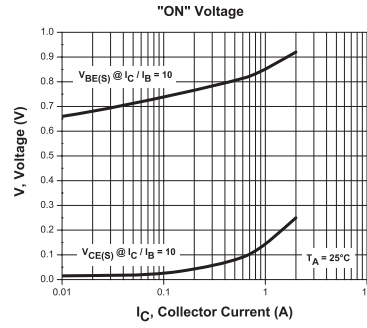
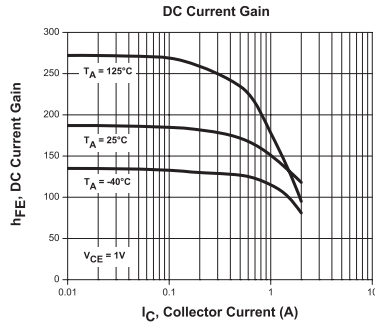

145 Adams Avenue
Hauppauge, NY 11788 USA
Tel: (631) 435-1110
Fax: (631) 435-1824
www.centralsemi.com

R3 (8-October 2008)