

### General Description

The MIC2290 is a 1.2MHz, PWM, boost-switching regulator housed in the small size 2mm × 2mm 8-pin MLF<sup>®</sup> package. The MIC2290 features an internal Schottky diode that reduces circuit board area and total solution cost. High power density is achieved with the MIC2290's internal 34V/0.5A switch, allowing it to power large loads in a tiny footprint.

The MIC2290 implements a constant frequency 1.2MHz PWM control scheme. The high frequency operation saves board space by reducing external component sizes. The fixed frequency PWM topology also reduces switching noise and ripple to the input power source.

The MIC2290's wide 2.5V to 10V input voltage allows direct operation from 3- to 4-cell NiCad/NiMH/Alkaline batteries, 1-and 2-cell Li-Ion batteries, as well as fixed 3.3V and 5V systems.

The MIC2290 is available in a low-profile 2mm×2mm 8-pin MLF<sup>®</sup> leadless package and operates from a junction temperature range of -40°C to +125°C.

Data sheets and support documentation can be found on Micrel's web site at: [www.micrel.com](http://www.micrel.com).

### Features

- Internal Schottky diode
- 2.5V to 10V input voltage
- Output voltage adjustable to 34V
- Over 500mA switch current
- 1.2MHz PWM operation
- Stable with ceramic capacitors
- <1% line and load regulation
- Low input and output ripple
- <1µA shutdown current
- UVLO
- Output overvoltage protection
- Over temperature protection
- 2mm × 2mm 8-pin MLF<sup>®</sup> package
- -40°C to +125°C junction temperature range

### Applications

- Organic EL power supply
- TFT LCD bias supply
- 12V DSL power supply
- CCD bias supply
- SEPIC converters

### Typical Application

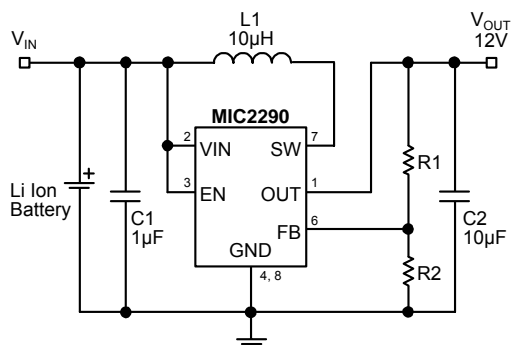

Simple 12V Boost Regulator

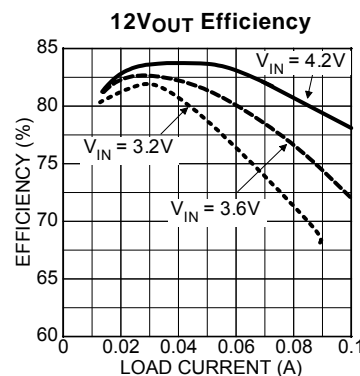

## Ordering Information

Part Number	Marking Code	Output Voltage	Overshoot Protection	Junction Temp. Range	Package	Lead Finish
MIC2290BML	SRC	Adj.	34V	-40° to +125°C	8-Pin 2x2 MLF <sup>®</sup>	Standard
MIC2290YML	SRC	Adj.	34V	-40° to +125°C	8-Pin 2x2 MLF <sup>®</sup>	Pb-Free

## Pin Configuration

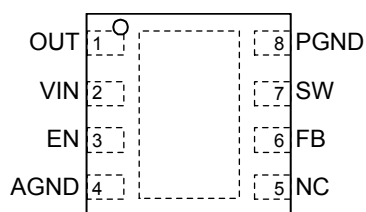

8-Pin 2mm x 2mm MLF<sup>®</sup> (ML)  
(Top View)

## Pin Description

Pin Number	Pin Name	Pin Function
1	OUT	Output pin (Output): Output voltage. Connect to FB resistor divider. This pin has an internal 34V output overvoltage clamp. See "Block Diagram" and "Applications" section for more information.
2	VIN	Supply (Input): 2.5V to 10V input voltage.
3	EN	Enable (Input): Logic high enables regulator. Logic low shuts down regulator.
4	AGND	Analog ground.
5	NC	No connect (no internal connection to die).
6	FB	Feedback (Input): Output voltage sense node. Connect feedback resistor network to this pin. $V_{OUT} = 1.24V \left( 1 + \frac{R1}{R2} \right)$ .
7	SW	Switch node (Input): Internal power Bipolar collector.
8	PGND	Power ground.
EP	GND	Ground (Return): Exposed backside pad.

**Absolute Maximum Ratings<sup>(1)</sup>**

Supply Voltage ( $V_{IN}$ )	12V
Switch Voltage ( $V_{SW}$ )	-0.3V to 34V
Enable Pin Voltage ( $V_{EN}$ )	-0.3V to $V_{IN}$
FB Voltage ( $V_{FB}$ )	6V
Switch Current ( $I_{SW}$ )	2A
Storage Temperature ( $T_s$ )	-65°C to +150°C
ESD Rating <sup>(3)</sup>	2kV

**Operating Ratings<sup>(2)</sup>**

Supply Voltage ( $V_{IN}$ )	2.5V to 10V
Ambient Temperature ( $T_J$ )	-40°C to +125°C
Package Thermal Resistance	
2x2 MLF-8 ( $\theta_{JA}$ )	93°C/W

**Electrical Characteristics<sup>(4)</sup>**

$T_A = 25^\circ\text{C}$ ,  $V_{IN} = V_{EN} = 3.6\text{V}$ ,  $V_{OUT} = 15\text{V}$ ,  $I_{OUT} = 40\text{mA}$ , unless otherwise noted. **Bold** values indicate  $-40^\circ\text{C} \leq T_J \leq \pm 125^\circ\text{C}$ .

Symbol	Parameter	Condition	Min	Typ	Max	Units
$V_{IN}$	Supply Voltage Range		<b>2.5</b>		<b>10</b>	V
$V_{UVLO}$	Undervoltage Lockout		1.8	2.1	2.4	V
$I_{VIN}$	Quiescent Current	$V_{FB} = 2\text{V}$ , (not switching)		2.5	5	mA
$I_{SD}$	Shutdown Current	$V_{EN} = 0\text{V}$ , <b>Note 5</b>		0.2	<b>1</b>	$\mu\text{A}$
$V_{FB}$	Feedback Voltage	( $\pm 1\%$ ) ( $\pm 2\%$ ) (Over Temp)	1.227 <b>1.215</b>	1.24	1.252 <b>1.265</b>	V V
$I_{FB}$	Feedback Input Current	$V_{FB} = 1.24\text{V}$		-450		nA
	Line Regulation	$3\text{V} \leq V_{IN} \leq 5\text{V}$		0.1	<b>1</b>	%
	Load Regulation	$5\text{mA} \leq I_{OUT} \leq 20\text{mA}$		0.2		%
$D_{MAX}$	Maximum Duty Cycle		<b>85</b>	90		%
$I_{SW}$	Switch Current Limit			0.75		A
$V_{SW}$	Switch Saturation Voltage	$I_{SW} = 0.5\text{A}$		450		mV
$I_{SW}$	Switch Leakage Current	$V_{EN} = 0\text{V}$ , $V_{SW} = 10\text{V}$		0.01	<b>5</b>	$\mu\text{A}$
$V_{EN}$	Enable Threshold	Turn on Turn off	<b>1.5</b>		<b>0.4</b>	V V
$I_{EN}$	Enable Pin Current	$V_{EN} = 10\text{V}$		20	40	$\mu\text{A}$
$f_{SW}$	Oscillator Frequency		1.05	1.2	1.35	MHz
$V_D$	Schottky Forward Drop	$I_D = 150\text{mA}$		0.8	1	V
$I_{RD}$	Schottky Leakage Current	$V_R = 30\text{V}$			<b>4</b>	$\mu\text{A}$
$V_{OVP}$	Overvoltage Protection	(nominal voltage)	30	32	34	V
$T_J$	Overtemperature Threshold Shutdown	Hysteresis		150 10		$^\circ\text{C}$ $^\circ\text{C}$

**Notes:**

1. Absolute maximum ratings indicate limits beyond which damage to the component may occur. Electrical specifications do not apply when operating the device outside of its operating ratings. The maximum allowable power dissipation is a function of the maximum junction temperature,  $T_{J(max)}$ , the junction-to-ambient thermal resistance,  $\theta_{JA}$ , and the ambient temperature,  $T_A$ . The maximum allowable power dissipation will result in excessive die temperature, and the regulator will go into thermal shutdown.
2. The device is not guaranteed to function outside its operating rating.
3. IC devices are inherently ESD sensitive. Handling precautions required. Human body model rating: 1.5K in series with 100pF.
4. Specification for packaged product only.
5.  $I_{SD} = I_{VIN}$ .

# Typical Characteristics

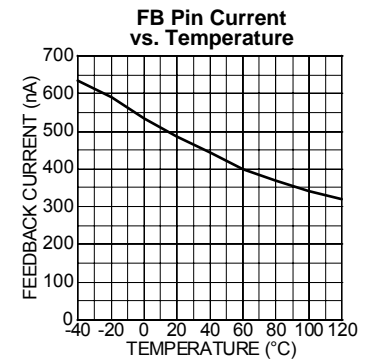
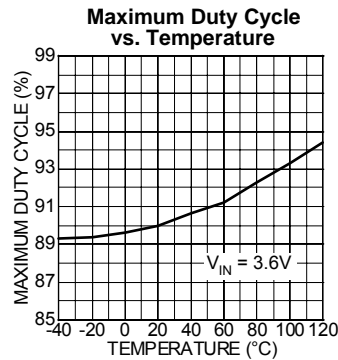
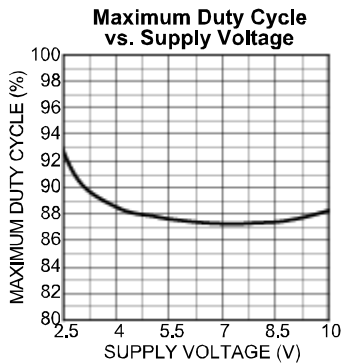
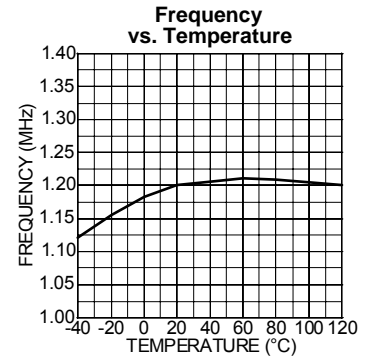
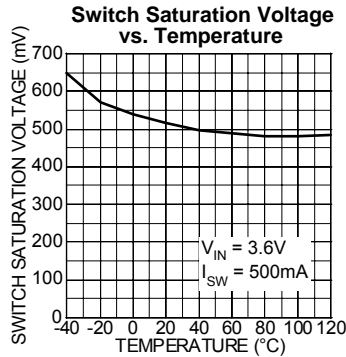
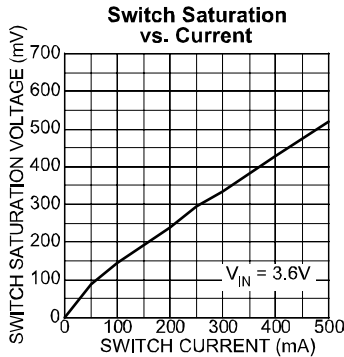
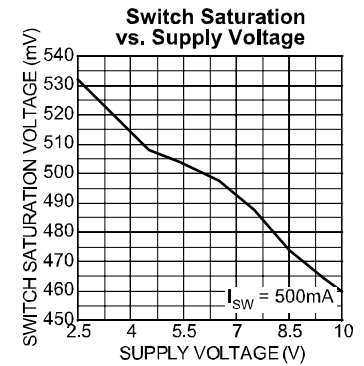
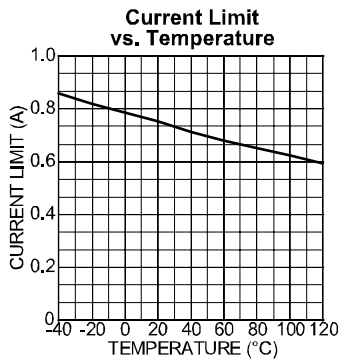
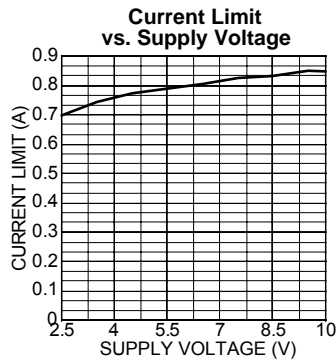
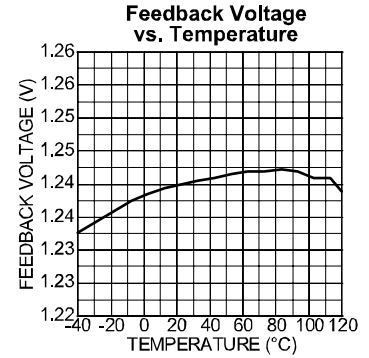
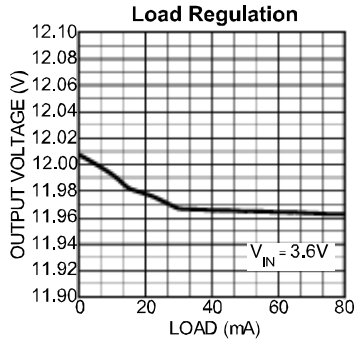
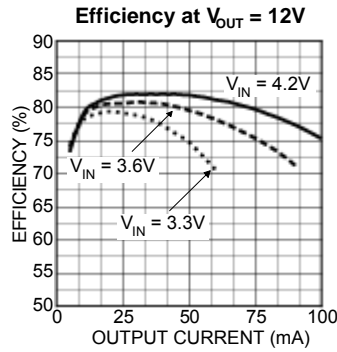

## Typical Characteristics (continued)

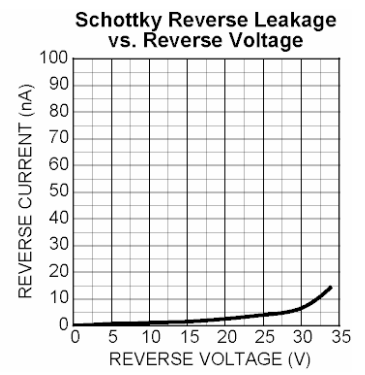
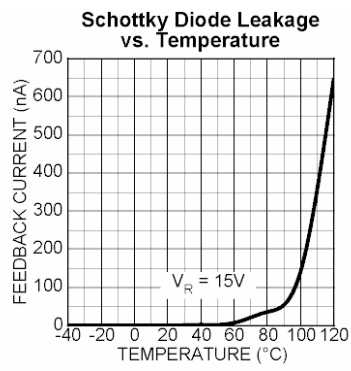
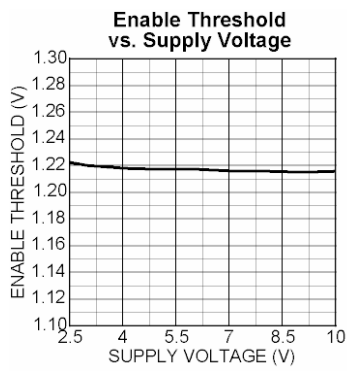

## Functional Characteristics

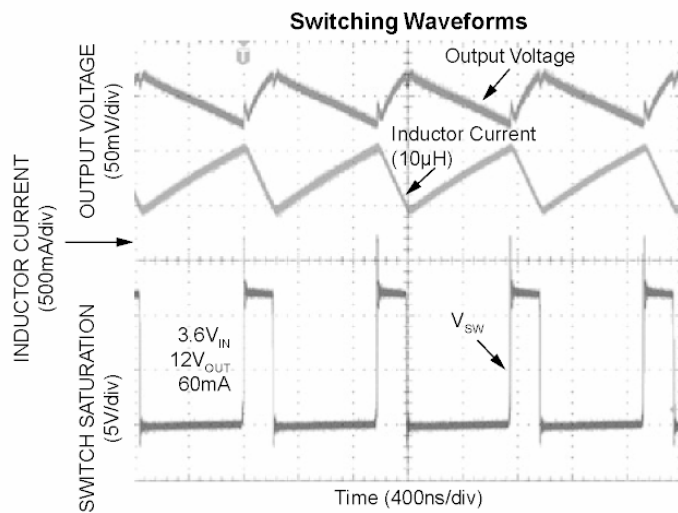
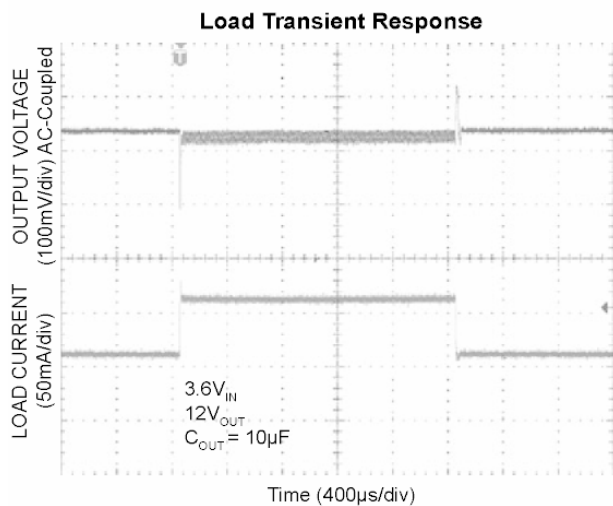
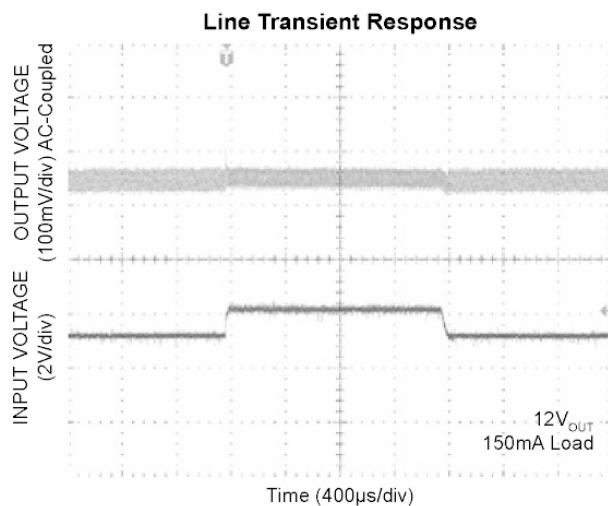
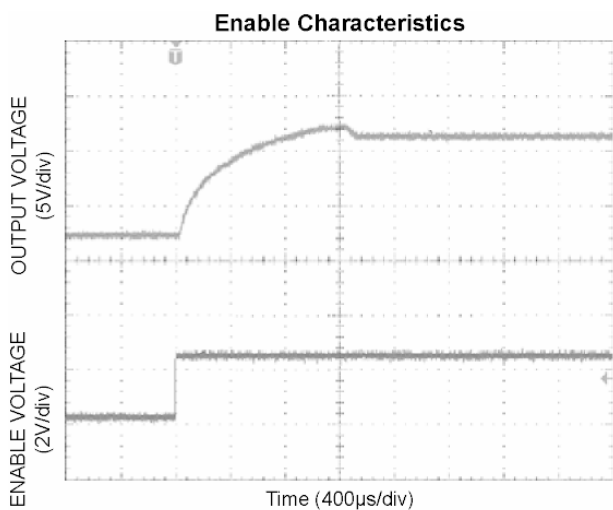

## Functional Diagram

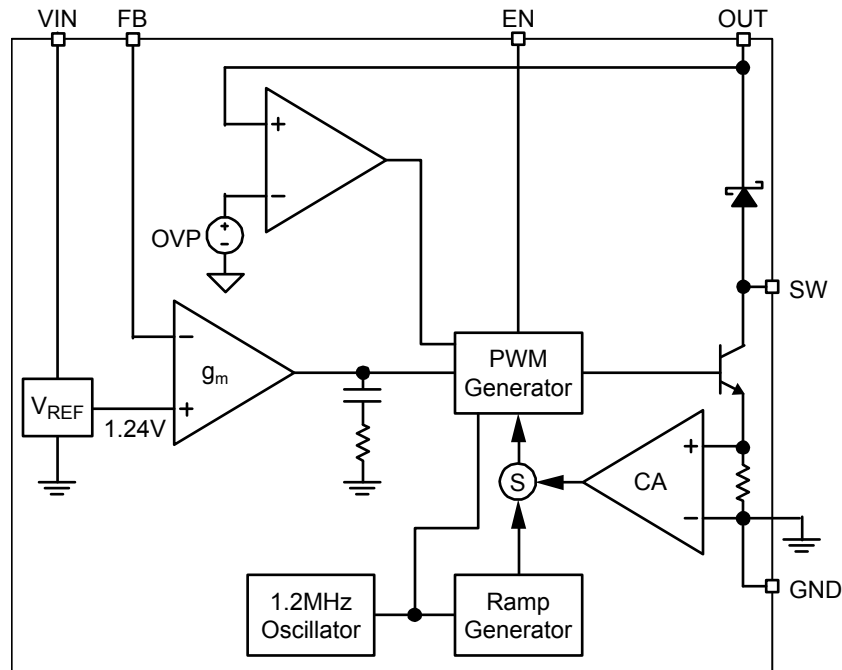

Figure 1. MIC2290 Block Diagram

## Functional Description

The MIC2290 is a constant frequency, PWM current mode boost regulator. The block diagram is shown in Figure 1. The MIC2290 is composed of an oscillator, slope compensation ramp generator, current amplifier,  $g_m$  error amplifier, PWM generator, and a 0.5A bipolar output transistor. The oscillator generates a 1.2MHz clock. The clock's two functions are to trigger the PWM generator that turns on the output transistor, and to reset the slope compensation ramp generator. The current amplifier is used to measure the switch current by amplifying the voltage signal from the internal sense resistor. The output of the current amplifier is summed with the output of the slope compensation ramp generator. This summed current-loop signal is fed to one of the inputs of the PWM generator.

The  $g_m$  error amplifier measures the feedback voltage through the external feedback resistors and amplifies the error between the detected signal and the 1.24V reference voltage. The output of the  $g_m$  error amplifier provides the voltage-loop signal that is fed to the other input of the PWM generator. When the current-loop signal exceeds the voltage-loop signal, the PWM generator turns off the bipolar output transistor. The next clock period initiates the next switching cycle, maintaining the constant frequency current-mode PWM control.

## Application Information

### DC-to-DC PWM Boost Conversion

The MIC2290 is a constant frequency boost converter. It operates by taking a DC input voltage and regulating a higher DC output voltage. Figure 2 shows a typical circuit. Boost regulation is achieved by turning on an internal switch, which draws current through the inductor (L1). When the switch turns off, the inductor's magnetic field collapses, causing the current to be discharged into the output capacitor through an internal Schottky diode (D1). Voltage regulation is achieved through pulse-width modulation (PWM).

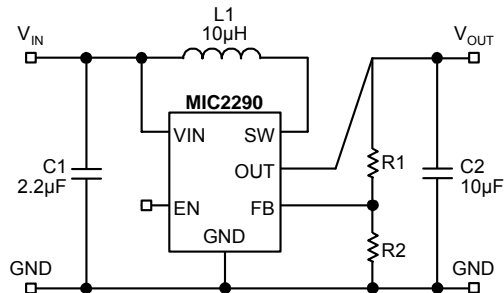

Figure 2. Typical Application Circuit

### Duty Cycle Considerations

Duty cycle refers to the switch on-to-off time ratio and can be calculated as follows for a boost regulator:

$$D = 1 - \frac{V_{IN}}{V_{OUT}}$$

The duty cycle required for voltage conversion should be less than the maximum duty cycle of 85%. Also, in light load conditions where the input voltage is close to the output voltage, the minimum duty cycle can cause pulse skipping. This is due to the energy stored in the inductor causing the output to overshoot slightly over the regulated output voltage. During the next cycle, the error amplifier detects the output as being high and skips the following pulse. This effect can be reduced by increasing the minimum load or by increasing the inductor value. Increasing the inductor value reduces peak current, which in turn reduces energy transfer in each cycle.

### Overvoltage Protection

For the MFLF<sup>®</sup> package option, there is an overvoltage protection function. If the feedback resistors are disconnected from the circuit or the feedback pin is shorted to ground, the feedback pin will fall to ground potential. This will cause the MIC2290 to switch at full duty cycle in an attempt to maintain the feedback voltage. As a result, the output voltage will climb out of control. This may cause the switch node voltage to exceed its maximum voltage rating, possibly damaging the IC and the external components. To ensure the highest level of protection, the MIC2290 OVP pin will shut the switch off

when an overvoltage condition is detected, saving itself and other sensitive circuitry downstream.

## Component Selection

### Inductor

Inductor selection is a balance between efficiency, stability, cost, size, and rated current. For most applications, a 10µH is the recommended inductor value; it is usually a good balance between these considerations.

Large inductance values reduce the peak-to-peak ripple current, affecting efficiency. This has an effect of reducing both the DC losses and the transition losses. There is also a secondary effect of an inductor's DC resistance (DCR). The DCR of an inductor will be higher for more inductance in the same package size. This is due to the longer windings required for an increase in inductance. Since the majority of input current (minus the MIC2290 operating current) is passed through the inductor, higher DCR inductors will reduce efficiency.

To maintain stability, increasing inductor size will have to be met with an increase in output capacitance. This is due to the unavoidable "right half plane zero" effect for the continuous current boost converter topology. The frequency at which the right half plane zero occurs can be calculated as follows:

$$F_{rhpz} = \frac{V_{IN}^2}{V_{OUT} \times L \times I_{OUT} \times 2\pi}$$

The right half plane zero has the undesirable effect of increasing gain, while decreasing phase. This requires that the loop gain is rolled off before this has significant effect on the total loop response. This can be accomplished by either reducing inductance (increasing RHPZ frequency) or increasing the output capacitor value (decreasing loop gain).

### Output Capacitor

Output capacitor selection is also a trade-off between performance, size, and cost. Increasing output capacitance will lead to an improved transient response, but also an increase in size and cost. X5R or X7R dielectric ceramic capacitors are recommended for designs with the MIC2290. Y5V values may be used, but to offset their tolerance over temperature, more capacitance is required. The following table shows the recommended ceramic (X5R) output capacitor value vs. output voltage.

Output Voltage	Recommended Output Capacitance
<6V	22µF
<16V	10µF
<34V	4.7µF

Table 1. Output Capacitor Selection



**Input capacitor**

A minimum 1 $\mu$ F ceramic capacitor is recommended for designing with the MIC2290. Increasing input capacitance will improve performance and greater noise immunity on the source. The input capacitor should be as close as possible to the inductor and the MIC2290, with short traces for good noise performance.

**Feedback Resistors**

The MIC2290 utilizes a feedback pin to compare the output to an internal reference. The output voltage is adjusted by selecting the appropriate feedback resistor network values. The R2 resistor value must be less than or equal to 5k $\Omega$  ( $R2 \leq 5k\Omega$ ). The desired output voltage can be calculated as follows:

$$V_{OUT} = V_{REF} \times \left( \frac{R1}{R2} + 1 \right)$$

where VREF is equal to 1.24V.

### Application Circuits

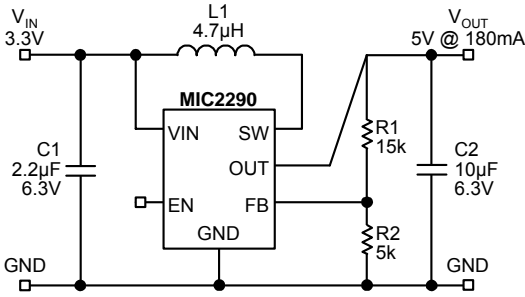

<b>C1</b>	2.2µF, 6.3V, 0805 X5R Ceramic Capacitor	08056D475MAT	AVX
<b>C2</b>	10µF, 6.3V, 0805 X5R Ceramic Capacitor	08056D106MAT	AVX
<b>L1</b>	4.7µH, 450mA Inductor	LQH32CN4R7N11	Murata

**Figure 3. 3.3V<sub>IN</sub> to 5V<sub>OUT</sub> @ 180mA**

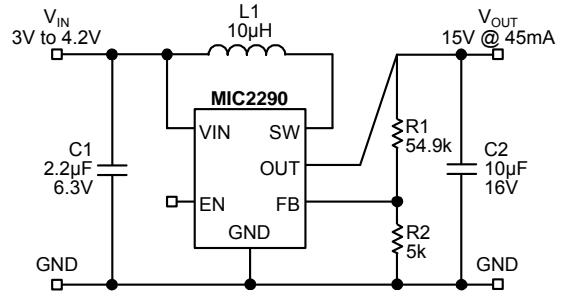

<b>C1</b>	2.2µF, 6.3V, 0603 X5R Ceramic Capacitor	06036D225MAT	AVX
<b>C2</b>	10µF, 16V, 1206 X5R Ceramic Capacitor	1206YD106MAT	AVX
<b>L1</b>	10µH, 450mA Inductor	LQH32CN100K11	Murata

**Figure 6. 3.3V<sub>IN</sub> to 4.2V<sub>OUT</sub> to 15V<sub>OUT</sub> @ 45mA**

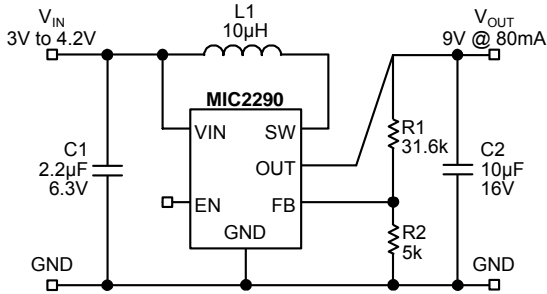

<b>C1</b>	2.2µF, 6.3V, 0603 X5R Ceramic Capacitor	06036D225MAT	AVX
<b>C2</b>	10µF, 16V, 1206 X5R Ceramic Capacitor	1206YD106MAT	AVX
<b>L1</b>	10µH, 450mA Inductor	LQH32CN100K11	Murata

**Figure 4. 3.3V<sub>IN</sub> to 4.2V<sub>OUT</sub> to 9V<sub>OUT</sub> @ 80mA**

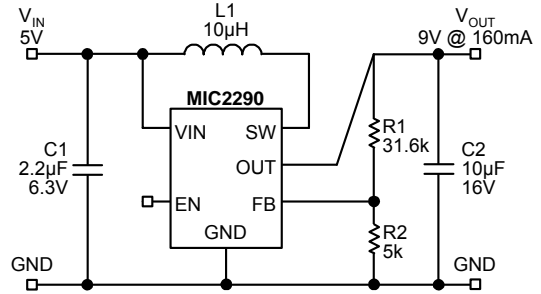

<b>C1</b>	2.2µF, 6.3V, 0603 X5R Ceramic Capacitor	06036D225MAT	AVX
<b>C2</b>	10µF, 16V, 1206 X5R Ceramic Capacitor	1206YD106MAT	AVX
<b>L1</b>	10µH, 450mA Inductor	LQH32CN100K11	Murata

**Figure 7. 5V<sub>IN</sub> to 9V<sub>OUT</sub> @ 160mA**

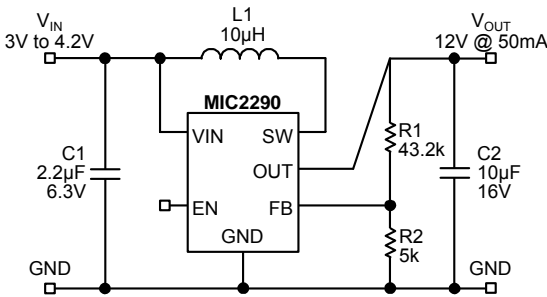

<b>C1</b>	2.2µF, 6.3V, 0603 X5R Ceramic Capacitor	06036D225MAT	AVX
<b>C2</b>	10µF, 16V, 1206 X5R Ceramic Capacitor	1206YD106MAT	AVX
<b>L1</b>	10µH, 450mA Inductor	LQH32CN100K11	Murata

**Figure 5. 3.3V<sub>IN</sub> to 4.2V<sub>OUT</sub> to 12V<sub>OUT</sub> @ 50mA**

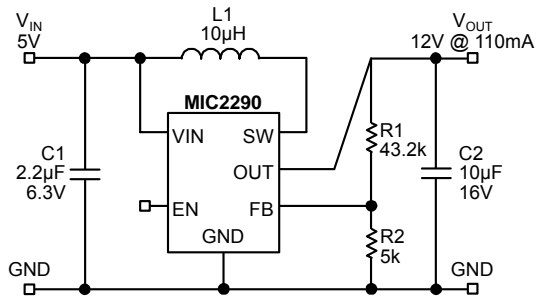

<b>C1</b>	2.2µF, 6.3V, 0603 X5R Ceramic Capacitor	06036D225MAT	AVX
<b>C2</b>	10µF, 16V, 1206 X5R Ceramic Capacitor	1206YD106MAT	AVX
<b>L1</b>	10µH, 450mA Inductor	LQH32CN100K11	Murata

**Figure 8. 5V<sub>IN</sub> to 12V<sub>OUT</sub> @ 110mA**

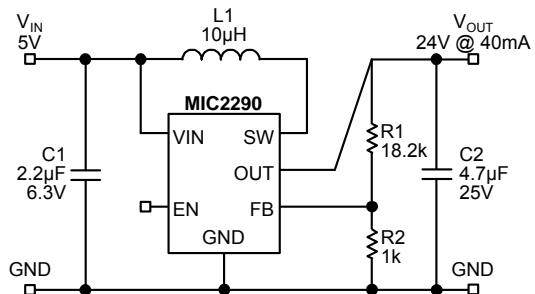

<b>C1</b>	2.2µF, 6.3V, 0603 X5R Ceramic Capacitor	06036D225MAT	AVX
<b>C2</b>	4.7µF, 25V, 1206 X5R Ceramic Capacitor	12063D475MAT	AVX
<b>L1</b>	10µH, 450mA Inductor	LQH32CN100K11	Murata

**Figure 9. 5V<sub>IN</sub> to 24V<sub>OUT</sub> @ 40mA**

# Package Information

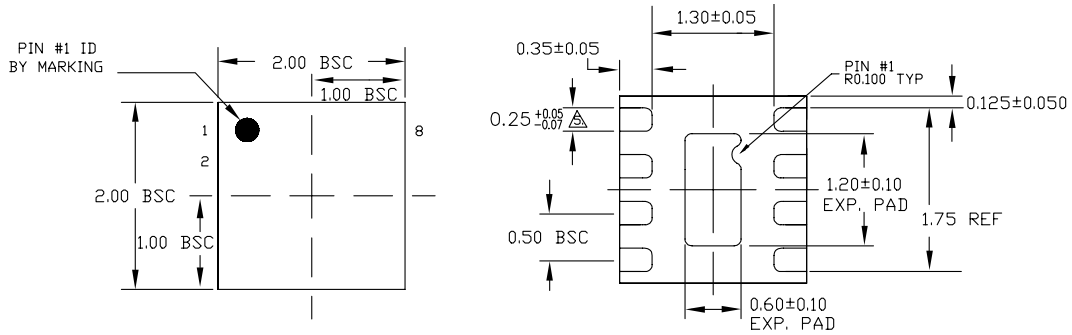

TOP VIEW

BOTTOM VIEW

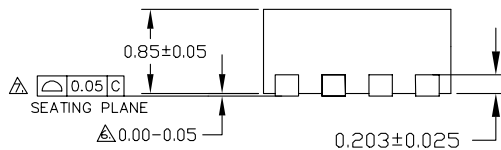

SIDE VIEW

- NOTE:
1. ALL DIMENSIONS ARE IN MILLIMETERS.
  2. MAX. PACKAGE WARPAGE IS 0.05 mm.
  3. MAXIMUM ALLOWABLE BURRS IS 0.076 mm IN ALL DIRECTIONS.
  4. PIN #1 ID ON TOP WILL BE LASER/INK MARKED.
- △ DIMENSION APPLIES TO METALIZED TERMINAL AND IS MEASURED BETWEEN 0.20 AND 0.25 mm FROM TERMINAL TIP.
- △ APPLIED ONLY FOR TERMINALS.
- △ APPLIED FOR EXPOSED PAD AND TERMINALS.

## 8-Pin 2mm x 2mm MLF<sup>®</sup> (ML)

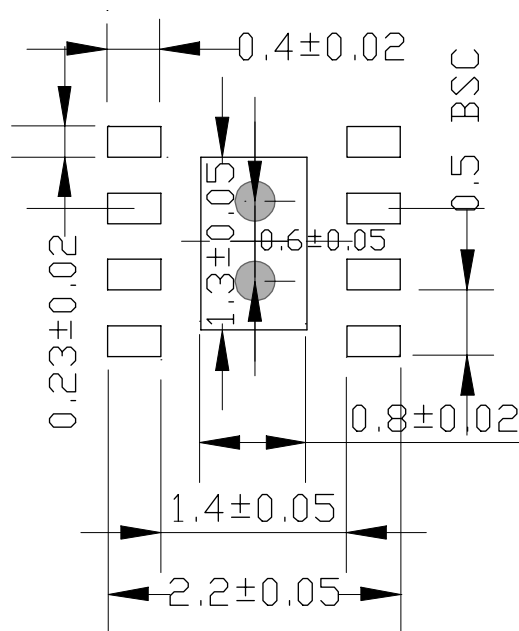

Grey Shaded area indicates Thermal Via. Size should be 0.300mm in diameter and it should be connected to GND for maximum thermal performance

## Recommended Land Pattern for (2mm x 2mm) 8-Pin MLF<sup>®</sup>

---

**MICREL, INC. 2180 FORTUNE DRIVE SAN JOSE, CA 95131 USA**  
TEL +1 (408) 944-0800 FAX +1 (408) 474-1000 WEB <http://www.micrel.com>

The information furnished by Micrel in this data sheet is believed to be accurate and reliable. However, no responsibility is assumed by Micrel for its use. Micrel reserves the right to change circuitry and specifications at any time without notification to the customer.

Micrel Products are not designed or authorized for use as components in life support appliances, devices or systems where malfunction of a product can reasonably be expected to result in personal injury. Life support devices or systems are devices or systems that (a) are intended for surgical implant into the body or (b) support or sustain life, and whose failure to perform can be reasonably expected to result in a significant injury to the user. A Purchaser's use or sale of Micrel Products for use in life support appliances, devices or systems is a Purchaser's own risk and Purchaser agrees to fully indemnify Micrel for any damages resulting from such use or sale.

© 2004 Micrel, Incorporated.