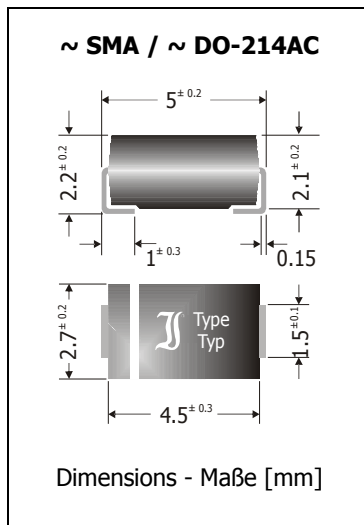

S1A ... S1Y
Standard Recovery SMD Rectifier Diodes
SMD-Gleichrichterdioden mit Standard-Sperrverzug
 $I_{FAV} = 1 \text{ A}$
 $V_F < 1.1 \text{ V}$
 $T_{jmax} = 150^\circ\text{C}$
 $V_{RRM} = 50...2000 \text{ V}$
 $I_{FSM} = 30/32 \text{ A}$
 $t_{rr} \sim 1500 \text{ ns}$

Version 2015-12-09

**Typical Applications**
50/60 Hz Mains Rectification,
Power Supplies, Polarity Protection
Commercial grade ¹⁾
Features
 V_{RRM} up to 2000 V
Compliant to RoHS, REACH,
Conflict Minerals ¹⁾
Mechanical Data ¹⁾
Taped and reeled 7500 / 13"
Weight approx. 0.07 g
Case material UL 94V-0
Solder & assembly conditions 260°C/10s
MSL = 1
**Typische Anwendungen**
50/60 Hz Netzgleichrichtung,
Stromversorgungen, Verpolschutz
Standardausführung ¹⁾
Besonderheiten
 V_{RRM} bis zu 2000 V
Konform zu RoHS, REACH,
Konfliktmineralien ¹⁾
Mechanische Daten ¹⁾
Gegurtet auf Rolle
Gewicht ca.
Gehäusematerial
Löt- und Einbaubedingungen
Maximum ratings ²⁾**Grenzwerte ²⁾**

Type	(Repetitive) Peak reverse volt. Typ (Periodische-)Spitzensperrspg.	Average forward current Dauergrenzstrom $T_T = 100^\circ\text{C}$	Repet. peak forward curr. Periodischer Spitzenstrom $f > 15 \text{ Hz}^3$	Peak forw. surge curr. Stoßstrom 50/60 Hz (10/8.3 ms)
	$V_{RRM} [\text{V}] / V_{RSM} [\text{V}]$	$I_{FAV} [\text{A}]$	$I_{FRM} [\text{A}]$	$I_{FSM} [\text{A}]$
S1A	50	1	6	30/32
S1B	100	1	6	30/32
S1D	200	1	6	30/32
S1G	400	1	6	30/32
S1J	600	1	6	30/32
S1K	800	1	6	30/32
S1M	1000	1	6	30/32
S1T	1300	1	6	30/32
S1W	1600	1	6	30/32
S1X	1800	1	6	30/32
S1Y	2000	1	6	30/32

Characteristics**Kennwerte**

Forward voltage – Durchlass-Spannung	$I_F = 1 \text{ A}$	V_F	< 1.1
Leakage current Sperrstrom	$V_R = V_{RRM}$	$T_j = 25^\circ\text{C}$ $T_j = 100^\circ\text{C}$	I_R I_R
Rating for fusing, $t < 10 \text{ ms}$ – Grenzlastintegral, $t < 10 \text{ ms}$		$T_A = 25^\circ\text{C}$	i^2t
Reverse recovery time – Sperrverzug	$I_F = 0.5 \text{ A}$ through/über $I_R = 1 \text{ A}$ to $I_R = 0.25 \text{ A}$	t_{rr}	typ. 1500 ns
Junction/Storage temperature – Sperrschicht-/Lagerungstemperatur		$T_{j/S}$	-50...+150°C
Thermal resistance junction-ambient – Wärmewiderstand Sperrschicht-Umgebung		R_{thA}	< 75 K/W ³⁾
Thermal resistance junction-terminal – Wärmewiderstand Sperrschicht-Anschluss		R_{thT}	< 30 K/W

1 Please note the [detailed information on our website](#) or at the beginning of the data book
Bitte beachten Sie die [detaillierten Hinweise auf unserer Internetseite](#) bzw. am Anfang des Datenbuches

2 $T_j = 25^\circ\text{C}$ unless otherwise specified – $T_j = 25^\circ\text{C}$ wenn nicht anders angegeben

3 Mounted on P.C. board with 60 mm² copper pads at each terminal – Montage auf Leiterplatte mit 60 mm² Kupferpad je Anschluss

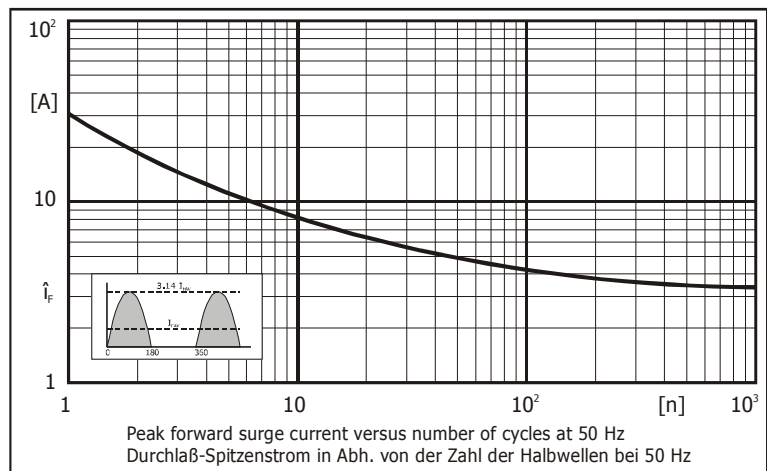
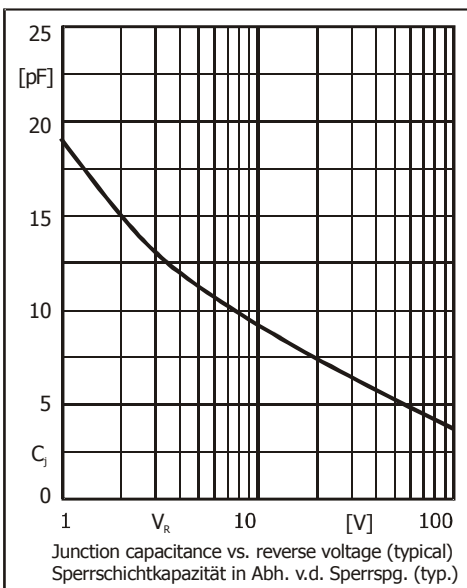
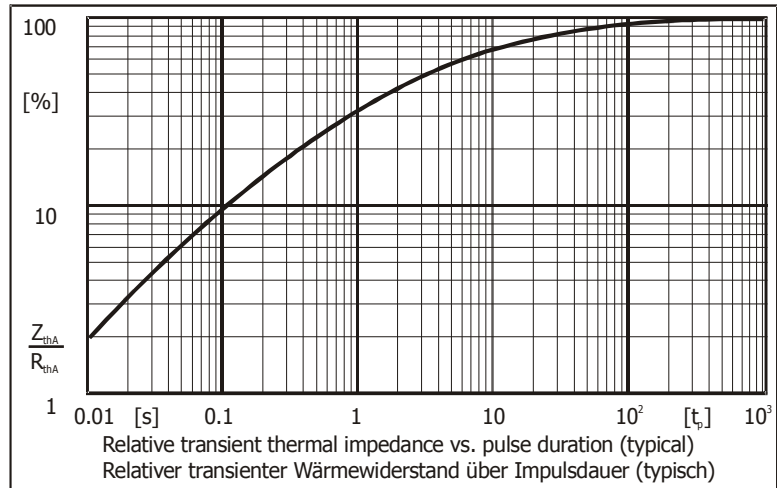
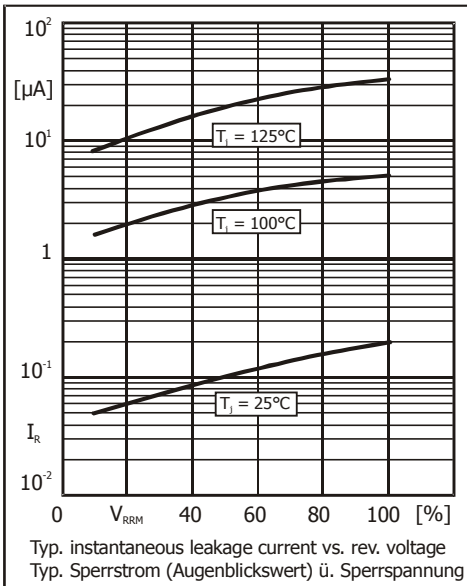
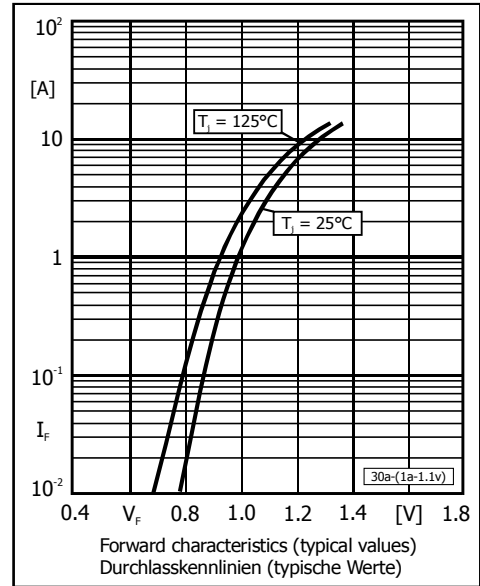
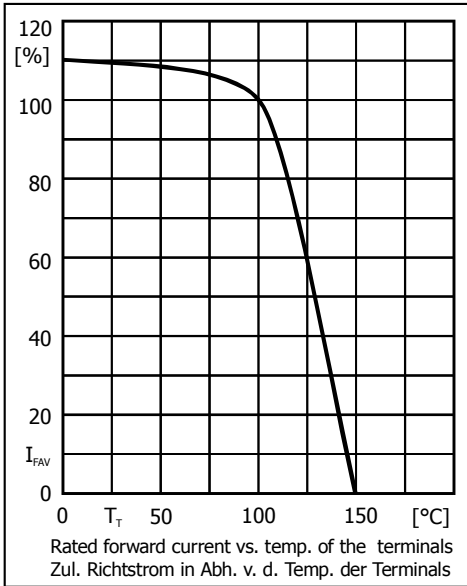

Disclaimer: See data book page 2 or [website](#)

Haftungsausschluss: Siehe Datenbuch Seite 2 oder [Internet](#)