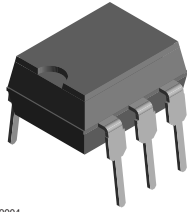
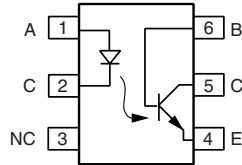


Optocoupler, Phototransistor Output, with Base Connection



H179004



FEATURES

- Current transfer ratio (see order information)
- Isolation test voltage 5300 V_{RMS}
- Lead (Pb)-free component
- Component in accordance to RoHS 2002/95/EC and WEEE 2002/96/EC



RoHS
COMPLIANT

DESCRIPTION

The IL1/IL2/IL5 are optically coupled isolated pairs employing GaAs infrared LEDs and silicon NPN phototransistor. Signal information, including a DC level, can be transmitted by the drive while maintaining a high degree of electrical isolation between input and output. The IL1/IL2/IL5 are especially designed for driving medium-speed logic and can be used to eliminate troublesome ground loop and noise problems. These couplers can be used also to replace relays and transformers in many digital interface applications such as CRT modulation.

AGENCY APPROVALS

- UL1577, file no. E52744 system code H or J, double protection
- DIN EN 60747-5-5 available with option 1
- BSI IEC 60950; IEC 60065

ORDER INFORMATION	
PART	REMARKS
IL1	CTR > 20 %, DIP-6
IL2	CTR > 100 %, DIP-6
IL5	CTR > 50 %, DIP-6
IL1-X006	CTR > 20 %, DIP-6 400 mil (option 6)
IL2-X006	CTR > 100 %, DIP-6 400 mil (option 6)
IL2-X009	CTR > 100 %, SMD-6 (option 9)
IL5-X009	CTR > 50 %, SMD-6 (option 9)

Note

For additional information on the available options refer to option information.

ABSOLUTE MAXIMUM RATINGS (1)					
PARAMETER	TEST CONDITION	PART	SYMBOL	VALUE	UNIT
INPUT					
Reverse voltage			V _R	6.0	V
Forward current			I _F	60	mA
Surge current			I _{FSM}	2.5	A
Power dissipation			P _{diss}	100	mW
Derate linearly from 25 °C				1.33	mW/°C
OUTPUT					
Collector emitter breakdown voltage		IL1	BV _{CEO}	50	V
		IL2	BV _{CEO}	70	V
		IL5	BV _{CEO}	70	V
Emitter base breakdown voltage			BV _{EBO}	7.0	V
Collector base breakdown voltage			BV _{CBO}	70	V
Collector current			I _C	50	mA
	t < 1.0 ms		I _C	400	mA
Power dissipation			P _{diss}	200	mW
Derate linearly from 25 °C				2.6	mW/°C



ABSOLUTE MAXIMUM RATINGS (1)					
PARAMETER	TEST CONDITION	PART	SYMBOL	VALUE	UNIT
COUPLER					
Package power dissipation			P_{tot}	250	mW
Derate linearly from 25 °C				3.3	mW/°C
Isolation test voltage (between emitter and detector referred to standard climate 23 °C/50 % RH, DIN 50014)			V_{ISO}	5300	V_{RMS}
Creepage distance				≥ 7.0	mm
Clearance distance				≥ 7.0	mm
Comparative tracking index per DIN IEC 112/VDE 0303, part 1			CTI	175	
Isolation resistance	$V_{IO} = 500 \text{ V}, T_{amb} = 25 \text{ °C}$		R_{IO}	≥ 10^{12}	Ω
	$V_{IO} = 500 \text{ V}, T_{amb} = 100 \text{ °C}$		R_{IO}	≥ 10^{11}	Ω
Storage temperature			T_{stg}	- 40 to + 150	°C
Operating temperature			T_{amb}	- 40 to + 100	°C
Junction temperature			T_j	100	°C
Soldering temperature (2)	2.0 mm from case bottom		T_{sld}	260	°C

Notes

(1) $T_{amb} = 25 \text{ °C}$, unless otherwise specified.

Stresses in excess of the absolute maximum ratings can cause permanent damage to the device. Functional operation of the device is not implied at these or any other conditions in excess of those given in the operational sections of this document. Exposure to absolute maximum ratings for extended periods of the time can adversely affect reliability.

(2) Refer to reflow profile for soldering conditions for surface mounted devices (SMD). Refer to wave profile for soldering conditions for through hole devices (DIP).

ELECTRICAL CHARACTERISTICS						
PARAMETER	TEST CONDITION	SYMBOL	MIN.	TYP.	MAX.	UNIT
INPUT						
Forward voltage	$I_F = 60 \text{ mA}$	V_F		1.25	1.65	V
Breakdown voltage	$I_R = 10 \text{ }\mu\text{A}$	V_{BR}	6.0	30		V
Reverse current	$V_R = 6.0 \text{ V}$	I_R		0.01	10	μA
Capacitance	$V_R = 0 \text{ V}, f = 1.0 \text{ MHz}$	C_O		40		pF
Thermal resistance junction to lead		R_{thjl}		750		K/W
OUTPUT						
Collector emitter capacitance	$V_{CE} = 5.0 \text{ V}, f = 1.0 \text{ MHz}$	C_{CE}		6.8		pF
Collector base capacitance	$V_{CB} = 5.0 \text{ V}, f = 1.0 \text{ MHz}$	C_{CB}		8.5		pF
Emitter base capacitance	$V_{EB} = 5.0 \text{ V}, f = 1.0 \text{ MHz}$	C_{EB}		11		pF
Collector emitter leakage voltage	$V_{CE} = 10 \text{ V}$	I_{CEO}		5.0	50	nA
Collector emitter saturation voltage	$I_{CE} = 1.0 \text{ mA}, I_B = 20 \text{ }\mu\text{A}$	V_{CEsat}		0.25		V
Base emitter voltage	$V_{CE} = 10 \text{ V}, I_B = 20 \text{ }\mu\text{A}$	V_{BE}		0.65		V
DC forward current gain	$V_{CE} = 10 \text{ V}, I_B = 20 \text{ }\mu\text{A}$	h_{FE}	200	650	1800	
DC forward current gain saturated	$V_{CE} = 0.4 \text{ V}, I_B = 20 \text{ }\mu\text{A}$	h_{FEsat}	120	400	600	
Thermal resistance junction to lead		R_{thjl}		500		K/W
COUPLER						
Capacitance (input to output)	$V_{I-O} = 0 \text{ V}, f = 1.0 \text{ MHz}$	C_{IO}		0.6		pF
Insulation resistance	$V_{I-O} = 500 \text{ V}$	R_S		10^{14}		Ω

Note

$T_{amb} = 25 \text{ °C}$, unless otherwise specified.

Minimum and maximum values are testing requirements. Typical values are characteristics of the device and are the result of engineering evaluation. Typical values are for information only and are not part of the testing requirements.

CURRENT TRANSFER RATIO							
PARAMETER	TEST CONDITION	PART	SYMBOL	MIN.	TYP.	MAX.	UNIT
Current transfer ratio (collector emitter saturated)	$I_F = 10 \text{ mA}$, $V_{CE} = 0.4 \text{ V}$	IL1	CTR_{CEsat}		75		%
		IL2	CTR_{CEsat}		170		%
		IL5	CTR_{CEsat}		100		%
Current transfer ratio (collector emitter)	$I_F = 10 \text{ mA}$, $V_{CE} = 10 \text{ V}$	IL1	CTR_{CE}	20	80	300	%
		IL2	CTR_{CE}	100	200	500	%
		IL5	CTR_{CE}	50	130	400	%
Current transfer ratio (collector base)	$I_F = 10 \text{ mA}$, $V_{CB} = 9.3 \text{ V}$	IL1	CTR_{CB}		0.25		%
		IL2	CTR_{CB}		0.25		%
		IL5	CTR_{CB}		0.25		%

SWITCHING CHARACTERISTICS							
PARAMETER	TEST CONDITION	PART	SYMBOL	MIN.	TYP.	MAX.	UNIT
NON-SATURATED							
Current time	$V_{CE} = 5.0 \text{ V}$, $R_L = 75 \Omega$, t_P measured at 50 % of output	IL1	I_F		20		mA
		IL2			4.0		
		IL5			10		
Delay time	$V_{CE} = 5.0 \text{ V}$, $R_L = 75 \Omega$, t_P measured at 50 % of output	IL1	t_D		0.8		μs
		IL2			1.7		
		IL5			1.7		
Rise time	$V_{CE} = 5.0 \text{ V}$, $R_L = 75 \Omega$, t_P measured at 50 % of output	IL1	t_r		1.9		μs
		IL2			2.6		
		IL5			2.6		
Storage time	$V_{CE} = 5.0 \text{ V}$, $R_L = 75 \Omega$, t_P measured at 50 % of output	IL1	t_s		0.2		μs
		IL2			0.4		
		IL5			0.4		
Fall time	$V_{CE} = 5.0 \text{ V}$, $R_L = 75 \Omega$, t_P measured at 50 % of output	IL1	t_f		1.4		μs
		IL2			2.2		
		IL5			2.2		
Propagation H to L	$V_{CE} = 5.0 \text{ V}$, $R_L = 75 \Omega$, t_P measured at 50 % of output	IL1	t_{PHL}		0.7		μs
		IL2			1.2		
		IL5			1.1		
Propagation L to H	$V_{CE} = 5.0 \text{ V}$, $R_L = 75 \Omega$, t_P measured at 50 % of output	IL1	t_{PLH}		1.4		μs
		IL2			2.3		
		IL5			2.5		
SATURATED							
Current time	$V_{CE} = 0.4 \text{ V}$, $R_L = 1.0 \text{ k}\Omega$, $V_{CL} = 5.0 \text{ V}$, $V_{TH} = 1.5 \text{ V}$	IL1	I_F		20		mA
		IL2			5.0		
		IL5			10		
Delay time	$V_{CE} = 0.4 \text{ V}$, $R_L = 1.0 \text{ k}\Omega$, $V_{CL} = 5.0 \text{ V}$, $V_{TH} = 1.5 \text{ V}$	IL1	t_D		0.8		μs
		IL2			1.0		
		IL5			1.7		
Rise time	$V_{CE} = 0.4 \text{ V}$, $R_L = 1.0 \text{ k}\Omega$, $V_{CL} = 5.0 \text{ V}$, $V_{TH} = 1.5 \text{ V}$	IL1	t_r		1.2		μs
		IL2			2.0		
		IL5			7.0		
Storage time	$V_{CE} = 0.4 \text{ V}$, $R_L = 1.0 \text{ k}\Omega$, $V_{CL} = 5.0 \text{ V}$, $V_{TH} = 1.5 \text{ V}$	IL1	t_s		7.4		μs
		IL2			5.4		
		IL5			4.6		

SWITCHING CHARACTERISTICS							
PARAMETER	TEST CONDITION	PART	SYMBOL	MIN.	TYP.	MAX.	UNIT
SATURATED							
Fall time	$V_{CE} = 0.4 \text{ V}, R_L = 1.0 \text{ k}\Omega,$ $V_{CL} = 5.0 \text{ V}, V_{TH} = 1.5 \text{ V}$	IL1	t_f		7.6		μs
		IL2			13.5		
		IL5			20		
Propagation H to L	$V_{CE} = 0.4 \text{ V}, R_L = 1.0 \text{ k}\Omega,$ $V_{CL} = 5.0 \text{ V}, V_{TH} = 1.5 \text{ V}$	IL1	t_{PHL}		1.6		μs
		IL2			5.4		
		IL5			2.6		
Propagation L to H	$V_{CE} = 0.4 \text{ V}, R_L = 1.0 \text{ k}\Omega,$ $V_{CL} = 5.0 \text{ V}, V_{TH} = 1.5 \text{ V}$	IL1	t_{PLH}		8.6		μs
		IL2			7.4		
		IL5			7.2		

COMMON MODE TRANSIENT IMMUNITY							
PARAMETER	TEST CONDITION	PART	SYMBOL	MIN.	TYP.	MAX.	UNIT
Common mode rejection output high	$V_{CM} = 50 \text{ V}_{P-P}, R_L = 1 \text{ k}\Omega, I_F = 10 \text{ mA}$		$ C_{MH} $		5000		$\text{V}/\mu\text{s}$
Common mode rejection output low	$V_{CM} = 50 \text{ V}_{P-P}, R_L = 1 \text{ k}\Omega, I_F = 10 \text{ mA}$		$ C_{ML} $		5000		$\text{V}/\mu\text{s}$
Common mode coupling capacitance			C_{CM}		0.01		pF

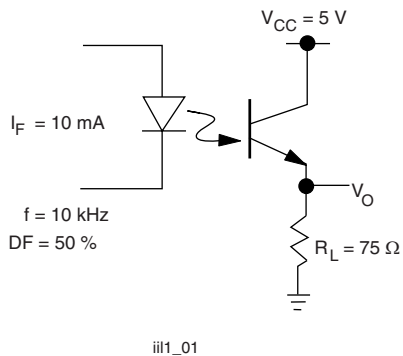
TYPICAL CHARACTERISTICS
 $T_{amb} = 25 \text{ }^\circ\text{C}$, unless otherwise specified


Fig. 1 - Non-Saturated Switching Schematic

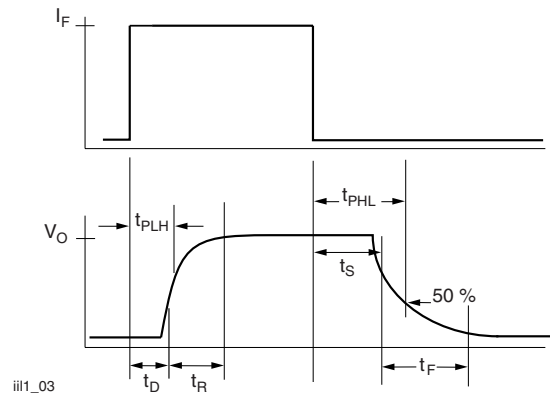


Fig. 3 - Non-Saturated Switching Timing

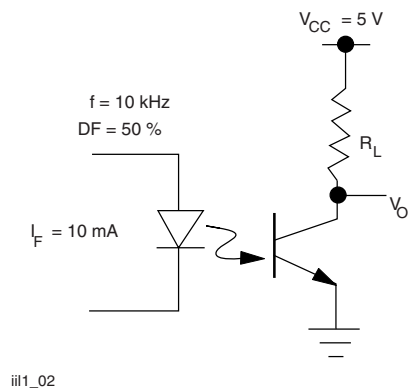


Fig. 2 - Saturated Switching Schematic

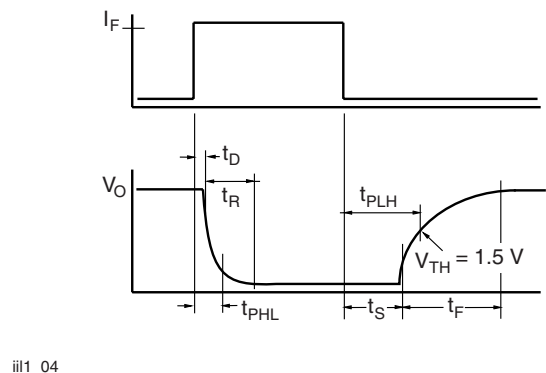


Fig. 4 - Saturated Switching Timing

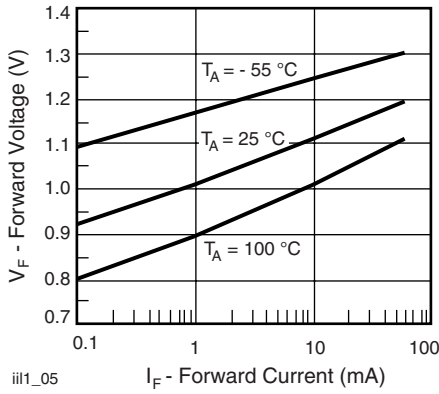


Fig. 5 - Forward Voltage vs. Forward Current

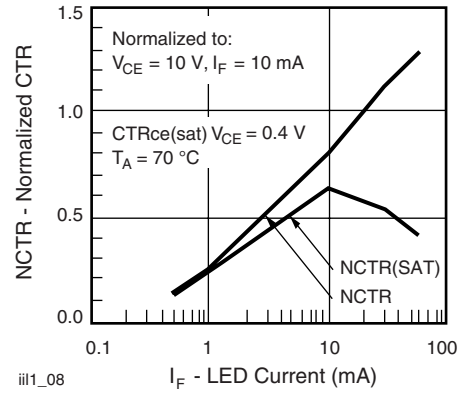


Fig. 8 - Normalized Non-Saturated and Saturated CTR vs. LED Current

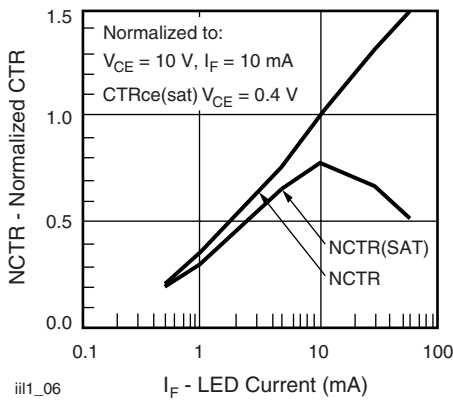


Fig. 6 - Normalized Non-Saturated and Saturated CTR vs. LED Current

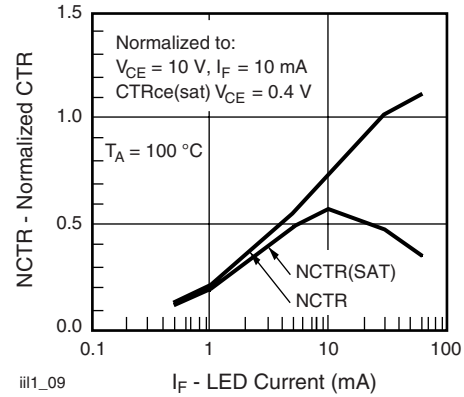


Fig. 9 - Normalized Non-Saturated and Saturated CTR, $T_{amb} = 100\text{ °C}$ vs. LED Current

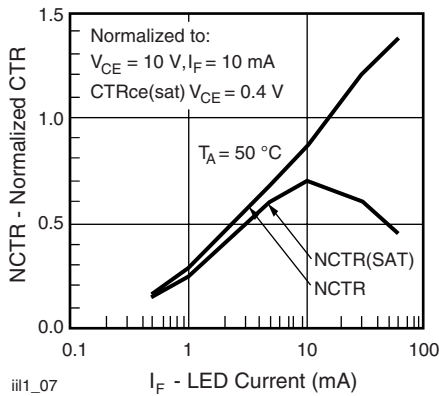


Fig. 7 - Normalized Non-Saturated and Saturated CTR vs. LED Current

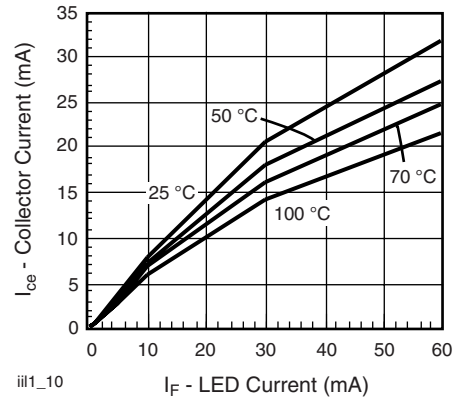


Fig. 10 - Collector Emitter Current vs. Temperature and LED Current

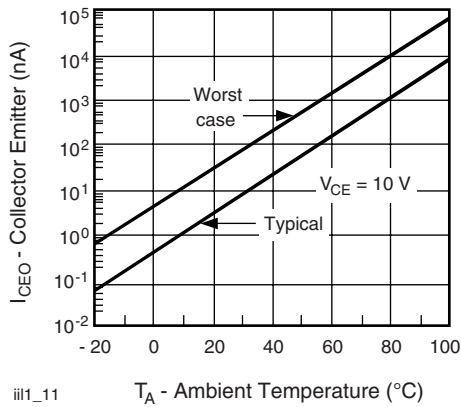


Fig. 11 - Collector Emitter Leakage Current vs. Temperature

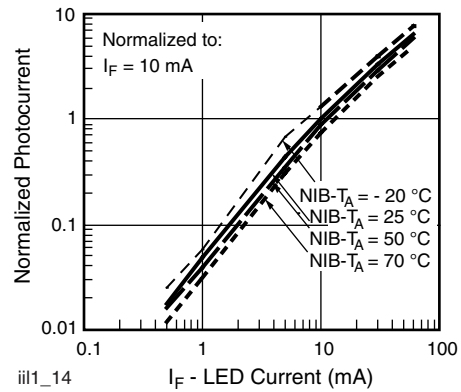
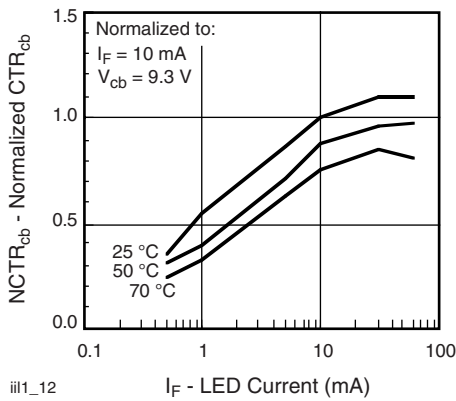
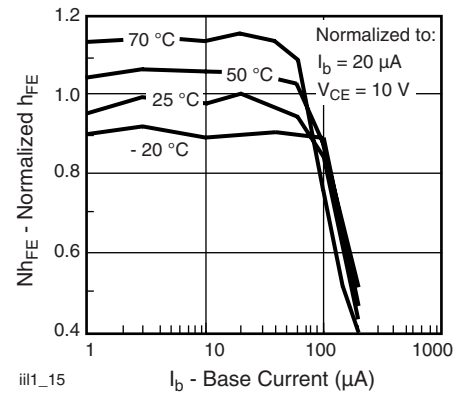
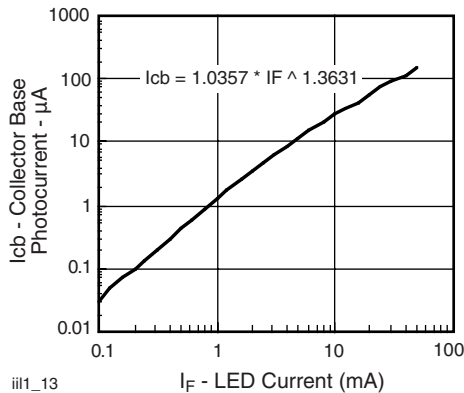
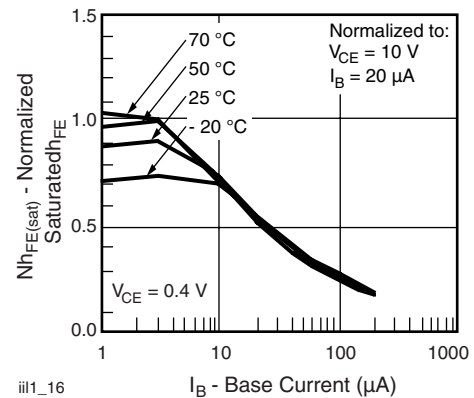

 Fig. 14 - Normalized Photocurrent vs. I_F and Temperature

 Fig. 12 - Normalized CTR_{cb} vs. LED Current and Temperature

 Fig. 15 - Normalized Non-Saturated h_{FE} vs. Base Current and Temperature


Fig. 13 - Collector Base Photocurrent vs. LED Current


 Fig. 16 - Normalized Saturated h_{FE} vs. Base Current and Temperature

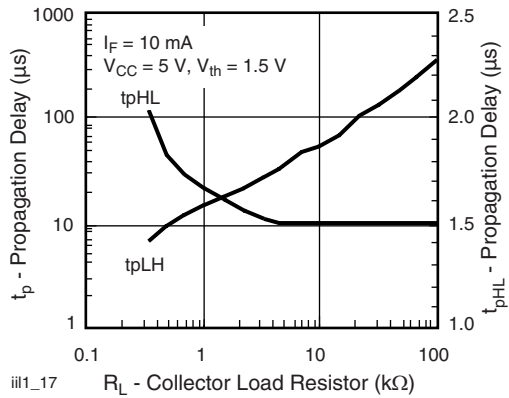
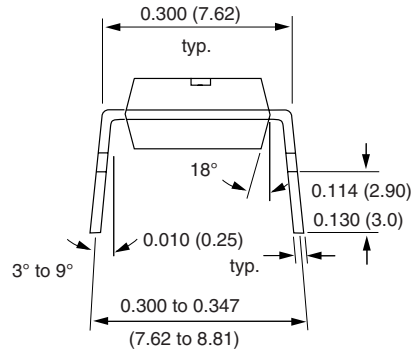
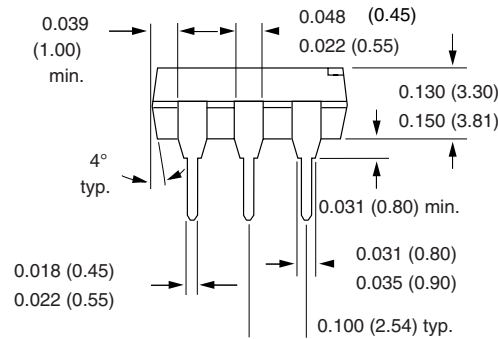
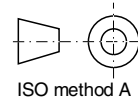
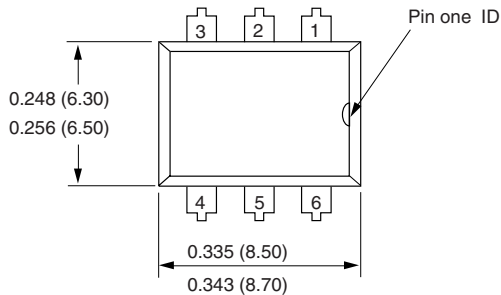


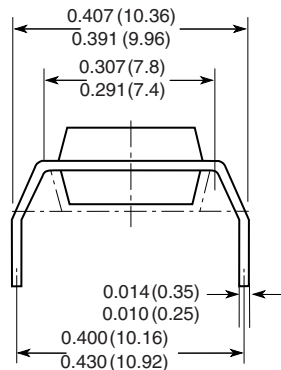
Fig. 17 - Propagation Delay vs. Collector Load Resistor

PACKAGE DIMENSIONS in inches (millimeters)



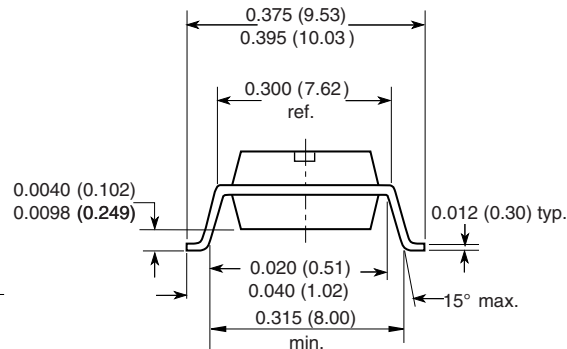
i178004

Option 6



18493

Option 9



**OZONE DEPLETING SUBSTANCES POLICY STATEMENT**

It is the policy of Vishay Semiconductor GmbH to

1. Meet all present and future national and international statutory requirements.
2. Regularly and continuously improve the performance of our products, processes, distribution and operating systems with respect to their impact on the health and safety of our employees and the public, as well as their impact on the environment.

It is particular concern to control or eliminate releases of those substances into the atmosphere which are known as ozone depleting substances (ODSs).

The Montreal Protocol (1987) and its London Amendments (1990) intend to severely restrict the use of ODSs and forbid their use within the next ten years. Various national and international initiatives are pressing for an earlier ban on these substances.

Vishay Semiconductor GmbH has been able to use its policy of continuous improvements to eliminate the use of ODSs listed in the following documents.

1. Annex A, B and list of transitional substances of the Montreal Protocol and the London Amendments respectively.
2. Class I and II ozone depleting substances in the Clean Air Act Amendments of 1990 by the Environmental Protection Agency (EPA) in the USA.
3. Council Decision 88/540/EEC and 91/690/EEC Annex A, B and C (transitional substances) respectively.

Vishay Semiconductor GmbH can certify that our semiconductors are not manufactured with ozone depleting substances and do not contain such substances.

We reserve the right to make changes to improve technical design
and may do so without further notice.

Parameters can vary in different applications. All operating parameters must be validated for each customer application by the customer. Should the buyer use Vishay Semiconductors products for any unintended or unauthorized application, the buyer shall indemnify Vishay Semiconductors against all claims, costs, damages, and expenses, arising out of, directly or indirectly, any claim of personal damage, injury or death associated with such unintended or unauthorized use.

Vishay Semiconductor GmbH, P.O.B. 3535, D-74025 Heilbronn, Germany



Disclaimer

All product specifications and data are subject to change without notice.

Vishay Intertechnology, Inc., its affiliates, agents, and employees, and all persons acting on its or their behalf (collectively, "Vishay"), disclaim any and all liability for any errors, inaccuracies or incompleteness contained herein or in any other disclosure relating to any product.

Vishay disclaims any and all liability arising out of the use or application of any product described herein or of any information provided herein to the maximum extent permitted by law. The product specifications do not expand or otherwise modify Vishay's terms and conditions of purchase, including but not limited to the warranty expressed therein, which apply to these products.

No license, express or implied, by estoppel or otherwise, to any intellectual property rights is granted by this document or by any conduct of Vishay.

The products shown herein are not designed for use in medical, life-saving, or life-sustaining applications unless otherwise expressly indicated. Customers using or selling Vishay products not expressly indicated for use in such applications do so entirely at their own risk and agree to fully indemnify Vishay for any damages arising or resulting from such use or sale. Please contact authorized Vishay personnel to obtain written terms and conditions regarding products designed for such applications.

Product names and markings noted herein may be trademarks of their respective owners.