

Special Load PCB Relay RP 3 SL

- 1 pole 16 A, 1 NO contact
- For high inrush currents,
- 120 A / 20 ms inrush peak current
- Mono- or bistable
- 4 kV / 8 mm coil-contact
- RoHS compliant (Directive 2002/95/EC) as per product date code 0404

Applications

Lighting control, timers, motor control, building automation



F0147-A

Approvals

VDE REG.-Nr. 3736 (DC versions only), **CE** **UL** us E214024, **KEMA** 2011340.05 (DC vers. only)
Technical data of approved types on request

Contact data

Contact configuration	1 NO
Contact set	single contact
Type of interruption	micro-disconnection
Rated current	16 A
Rated voltage / max.switching voltage AC	240/400 VAC
Limiting continuous current	16 A
Maximum breaking capacity AC	4000 VA
Limiting making capacity, max 4 s, duty factor 10% peak value, max 20 ms	25 A 120 A
Contact material	AgSnO ₂
Mechanical endurance DC	> 20x10 ⁶ cycles
bistable	> 1x 10 ⁶ cycles
Rated frequency of operation with / without load	16 / 1200 min ⁻¹

Contact ratings

Type	Load	Cycles
RP3SL	16 A, 250 VAC, 70°C, 16 min ⁻¹ , IEC61810-1	5x10 ⁴
RP3SL	12 A, 250 VAC, 70°C, 16 min ⁻¹ , IEC61810-1	1x10 ⁵

Coil data

Coil data, monostable coil

Rated coil voltage range	5...110 VDC
Coil power	typ 520 mW
Operative range RTII / RTIII	2 / 1

Coil versions, DC-coil

Coil code	Rated voltage VDC	Operate voltage VDC	Release voltage VDC	Coil resistance Ω	Rated coil power mW
012	12	9.0	1.2	270±10%	533
024	24	18.0	2.4	1100±15%	524
048	48	36.0	4.8	4400±15%	524
060	60	45.0	6.0	6540±15%	550

All figures are given for coil without preenergization, at ambient temperature +23°C
Other coil voltages on request

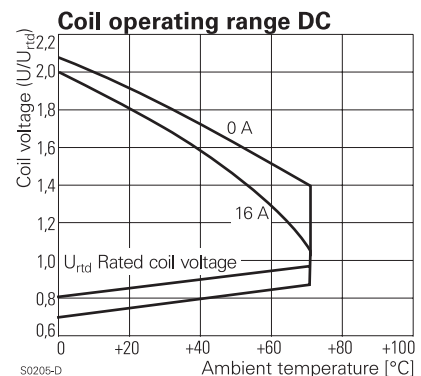
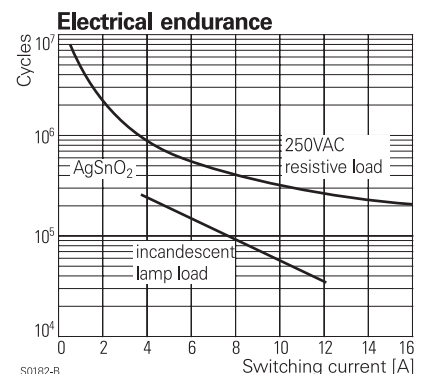
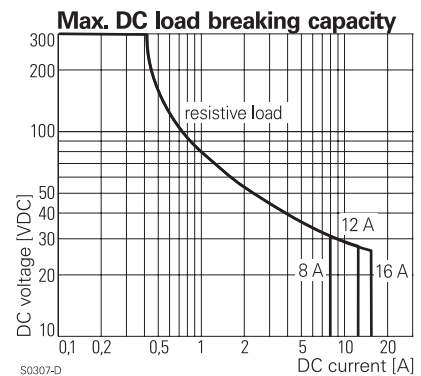

Coil data, bistable coils	1 coil	2 coils
Rated coil voltage range	5...24 VDC	
Coil power	typ 1,25 W	
Operative range	1	
Reset voltage minimum / maximum, % of U_{rd}	70% / 110%	75% / 120%
Minimum energization duration	20 ms	
Maximum energization duration	1 min at < 50% DF	

Coil versions, bistable DC-coil

Coil code	Rated voltage VDC	Operate voltage VDC	Reset voltage VDC	Reset R1 Ω / W	Coil resistance Ω	Rated coil power mW
bistable, 1 coil						
A05	5	3.7	3.6	39/0.5	21±10%	1190
A12	12	9.0	8.7	220/0.5	115±10%	1252
A24	24	18.0	16.7	820/0.5	460±10%	1252
bistable, 2 coils						
F12	12	9.0	9.0		105±15%	1371
F24	24	18.0	18.0		460±15%	1252

All figures are given for coil without preenergization, at ambient temperature +23°C, duty factor 20%. Other coil voltages on request

Insulation

Dielectric strength coil-contact circuit	4000 V _{rms}	
open contact circuit	2000 V _{rms}	
Clearance / creepage coil-contact circuit	≥ 8 / 8 mm	
Material group of insulation parts	≥ IIIa	
Tracking index of relay base	PTI 250 V	
Insulation to IEC 60664-1		
Type of insulation coil-contact circuit	basic	
open contact circuit	functional	
Rated insulation voltage	250 V	
Pollution degree	3	2
Rated voltage system	240 V	400 V
Overvoltage category	III	

Other data

RoHS - Directive 2002/95/EC	compliant as per product date code 0404	
Flammability class according to UL94	V-2	
Ambient temperature range RTII - flux proof	-40...+70°C	
RTIII - wash tight	-40...+35°C	
Operate- / release time DC coil	typ 8 / 2 ms	
Operate- / reset time bistable coils	typ 6 / 2 ms	
Bounce time	typ 2 ms	
Vibration resistance (function), opening of closed contact	20 g	
Shock resistance (destruction)	100 g	
Category of protection	RTII - flux proof, RTIII - wash tight	
Mounting	pcb or on socket	
Mounting distance 12A / 16A	0 / 3 mm	
Resistance to soldering heat flux proof version	270 °C / 10 s	
wash tight version	260°C / 5 s	
Relay weight	18 g	
Packaging unit monostable, bistable 1 coil	20 / 500 pcs	
bistable 2 coils	100 pcs	

Accessories

For monostable and bistable 1 coil version, details see accessories RT

Coil operating range DC

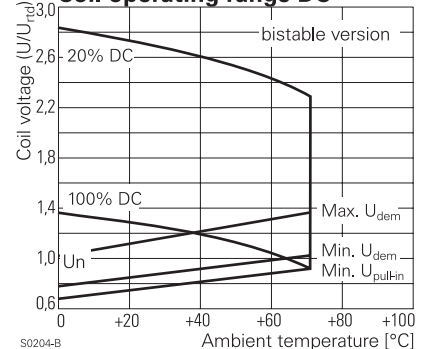

Circuit scheme for bistable 1 coil

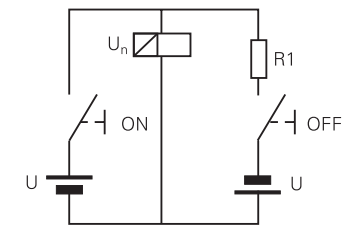

PCB layout / terminal assignment

Bottom view on solder pins

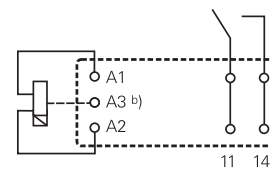
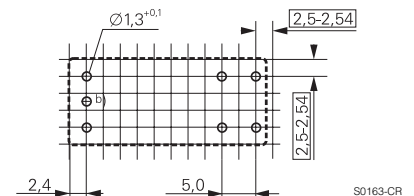

Bistable versions:
Indicated contact position during or after coil energization with reset voltage.

2-coil versions:
Operate A2, A3
Reset A1, A3

b) for 2 coil version only

Special Load PCB Relay RP 3 SL (Continued)

Dimensions

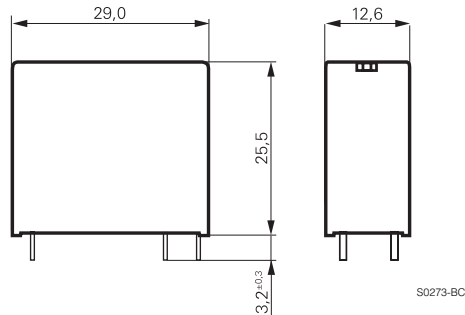

Product key

Type	R	P		S	L			
Version	3 flux proof		7	wash tight				
Contact configuration / contact material	SL 1 NO contact, AgSnO ₂							
Coil	Coil code: please refer to coil versions table							

Preferred types in bold print

Product key	Version	Contacts	Coil	Coil	Part number
RP3SL005	16 A	1 NO contact	DC-coil	5 VDC	0-1393230-7
RP3SL012	flux proof	AgSnO ₂		12 VDC	0-1393230-9
RP3SL024				24 VDC	1-1393230-1
RP3SLA12			bistable	12 VDC	0-1393230-3
RP3SLA24			1-coil	24 VDC	0-1393230-4
RP3SLF12			bistable	12 VDC	0-1393230-5
RP3SLF24			2-coils	24 VDC	0-1393230-6
RP7SL012	16 A		DC-coil	12 VDC	6-1393231-5
RP7SL024	wash tight			24 VDC	6-1393231-6