

Toggle Switches, A Series, Part Number Matrix

"A" SERIES DESIGN FEATURES

- Toggle – Machined brass, heavy nickel plated.
- Bushing & Frame – Rigid one-piece die cast, copper flashed, heavy nickel plated.
- Fixed Contact – Welded construction.
- Terminal Seal – Epoxy sealing of terminals is standard.

MATERIAL SPECIFICATIONS:

ContactsGold/gold flash
 Silver/tin lead
 Case MaterialThermoset
 Terminal SealEpoxy

TYPICAL PERFORMANCE CHARACTERISTICS:

Contact RatingSilver: 2 A @ 250 VAC or 5 A @ 125 VAC
 Silver: 2 A @ 30 VDC
 Gold: 0.4 VA @ 20 VAC/DC max.
 Insulation Resistance1,000 Megohms min. @ 500 VDC.
 Dielectric Strength1,000 Volts RMS @ sea level initial
 Electrical LifeUp to 30,000 Cycles

ENVIRONMENTAL SPECIFICATIONS

Operating Temperature.....-4°F to + 185°F (-20°C to + 85°C)
 Storage Temperature.....-49°F to + 212°F (-45°C to + 100°C)
 Note: Hardware included with switch

C

Gemini Series

DESIGN

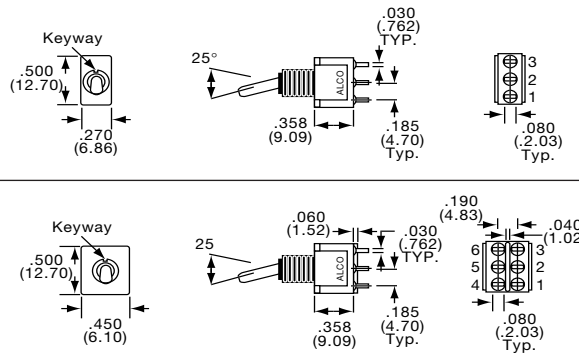
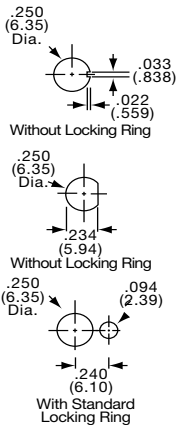
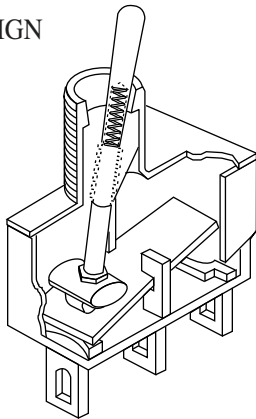

PART NUMBERING

Model	Function	Toggle	Bushing	Terminal	Contact	K, K1: Cap Color	Option
A1 Single Pole	double pole case only	S Bat. Long		Z Wire Lug	Q Silver B Gold G Gold over Silver Vertical Support V30 V40 V90 W Wire Wrap Z3 Quick Connect	(Nickel Standard) 0 Black 2 Red	U.L.(Q or G contact only) Note: For surface mount termination, use the "TST" series, Page C7
A2 Double Pole		K Locking		AV2 Vertical Right Angle			
01 On-On		K1 Locking		C Printed Circuit			
03 On-Off-On		M Bat. Short		V30 V40 V90 Vertical Support			
05 (On)-Off-(On)		P3 Flatted (with Y only)		W Wire Wrap			
07 On-Off-(On)		P4 Flatted (with Y only)		Z3 Quick Connect			
08 On-(On)		T Large Toggle		Y 1/4-40 threaded, .35" long, slotted			
11 On-On-On		T1 Large Toggle & Bushing (15/32)		Y9 unthreaded, .35" long			
13 On-On-(On)		T1 Large Toggle & Bushing (15/32)		CW 1/4-40 threaded, .37" long, actuator & bushing flange environmental seals S & M Toggles only			
15 (On)-On-(On)		T2P Large Flatted Toggle and Bushing (15/32)		D 1/4-40 threaded, .28" long, slotted			
				D9 Unthreaded, .28" long			
				H 1/4-40 threaded, flanged, .30" long			

See page C23 for SP3T wiring diagram.

Other Options

- N** Black finish toggle, bushing and hardware. Add "N" to end of part number, but before U.L. option.
- O** Internal O-ring environmental actuator seal. Add letter after toggle option: S & M.
- P** Anti-Push-In/Anti rotate. Add letter after toggle S & M.

Toggle Switches, A Series, Options

FUNCTIONS

The following functions available in SP or DP.

01	2 Positions	None indicates no mechanical position		On	None	On
03	3 Positions	Off indicates a mechanical position with no electrical connection.		On	Off	On
05	3 Positions	(On) indicates momentary action.		(On)	Off	(On)
07	3 Positions			(On)	Off	On
08	2 Positions			(On)	None	On
SPDT, connect terminals:						
DPDT, connect terminals:						

11	3 Positions		On	On	On
13	3 Positions		(On)	On	On
15	3 Positions		(On)	On	(On)

Functions available in DP case only

Connect terminals:

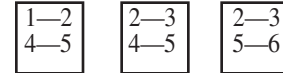

* SP3T functions achieved with external jumper installed by customer

WIRING DIAGRAM FOR FUNCTIONS

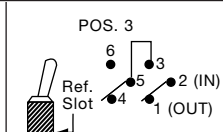
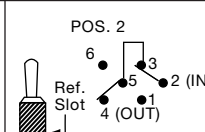
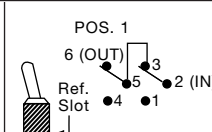
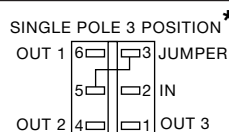
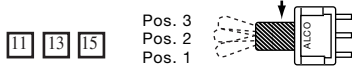

TOGGLES

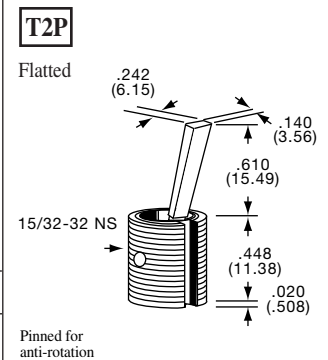
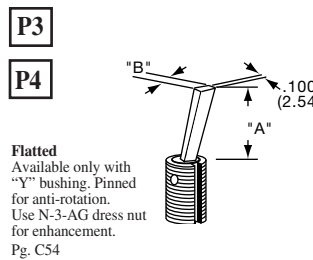
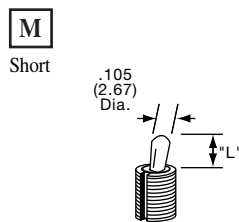
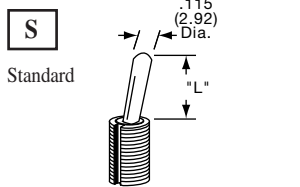

Dimension "L"	Bushing	Dimension "L"	Bushing Type	Actuator	"Dimension" "B"	
.410 (10.41)	"Y", "H", "CW"	.200 (5.08)	"Y", "H", "CW"	P3	.450 (11.43)	.200 (5.08)
.480 (12.19)	"D", "D9"	.270 (6.86)	"D", "D9"	P4	.250 (6.35)	.165 (4.19)

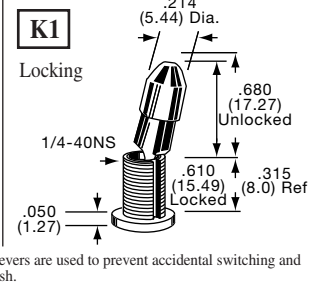
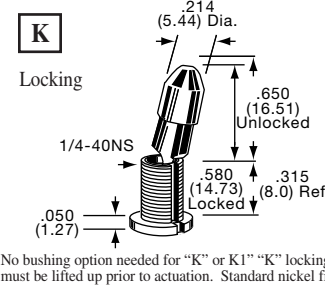
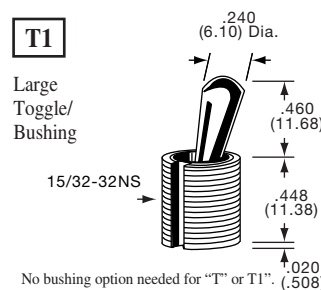
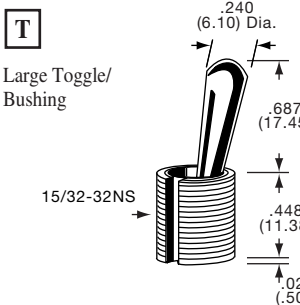

Toggle Switches, A Series, Options

BUSHINGS

Y

1/4-40 Thread
.35" long, slotted
(Standard)

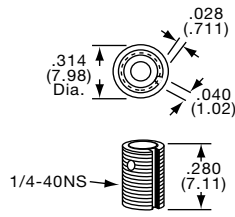

D9

Unthreaded
.28" long

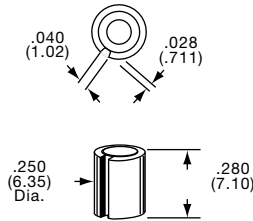

Used with
Z, C & W
terminations

H

1/4-40 Thread
Flanged, .30" long

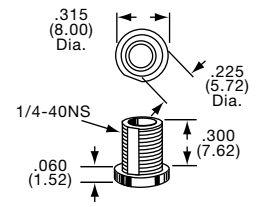

D

1/4-40 Thread
.28" long, slotted

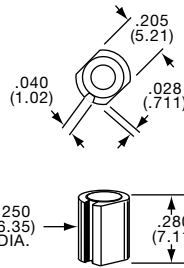
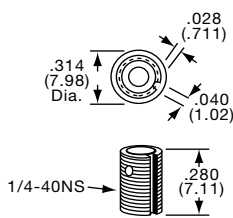

Used with
A, AV2, V30
V80 & V90
terminations

CW

Threaded
Splashproof

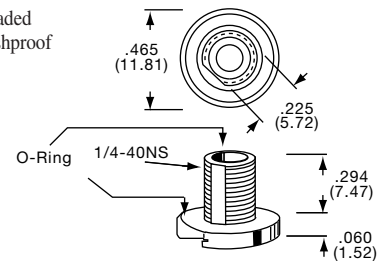

For S & M Toggles

TERMINALS

Z

Wire Lug

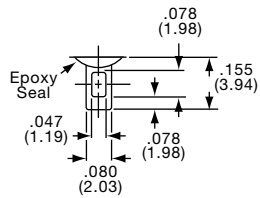

Z3

Quick Connect

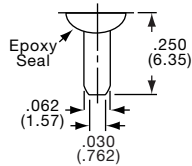

Mates with Tyco
61454 or 60900.

W

Wire Wrap

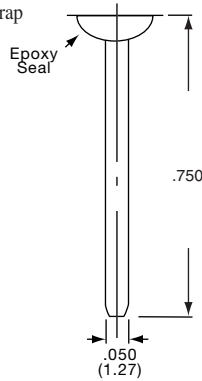

C

Printed Circuit

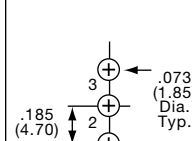
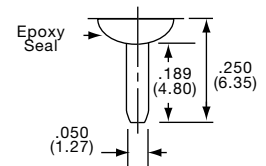

Single pole

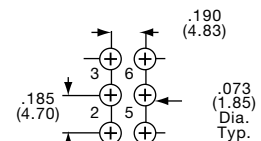

Double pole

Gemini Series

Toggle Switches, A Series, Options

TERMINALS

A

Right Angle
Single Pole

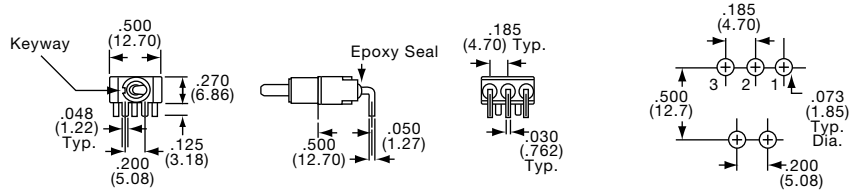

Note: Terminal numbers viewed from top of P.C. boards.

A

Right Angle
Double Pole

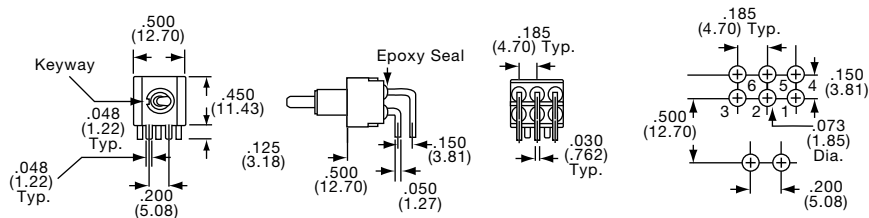

Note: Terminal numbers viewed from top of P.C. boards.

AV2

Vertical Right Angle
Single Pole

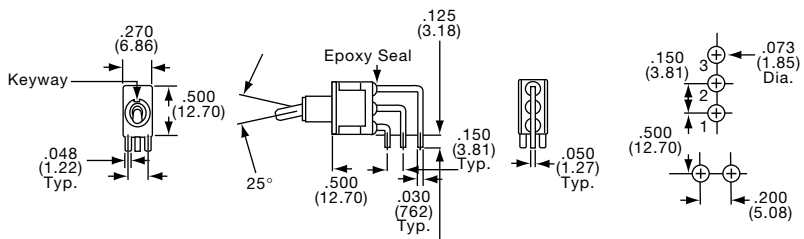

Note: Terminal numbers viewed from top of P.C. boards.

AV2

Vertical Right Angle
Double Pole

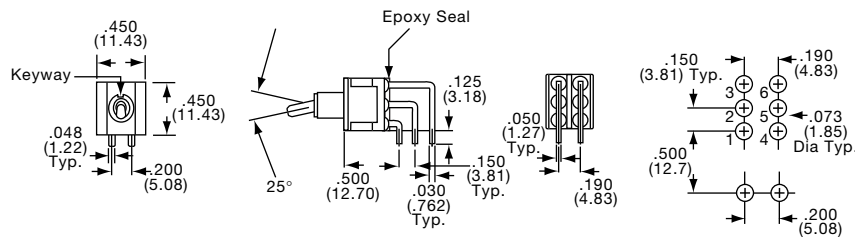

Note: Terminal numbers viewed from top of P.C. boards.



Toggle Switches, A Series, Options

TERMINALS NOTE: Terminal numbers viewed from top of P.C. board

V30 V40 V90

Vertical Support Bracket
Single Pole

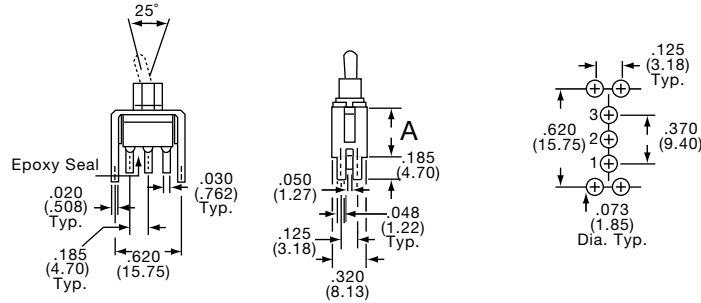

Option Code	Dim."A"
V30	.460 (11.68)
V40	.630 (16.00)
V90	1.150 (29.21)

Vertical Support Bracket
Double Pole

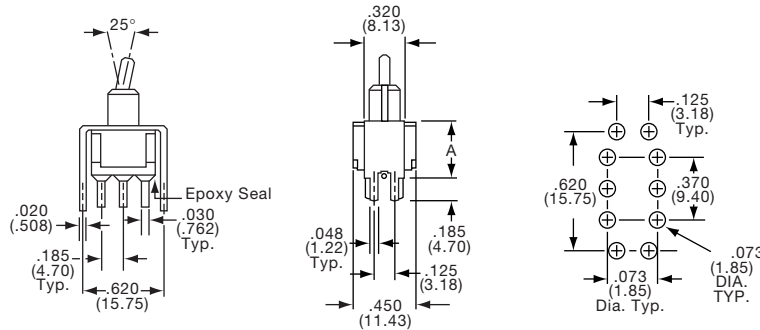

Option Code	Dim."A"
V30	.460 (11.68)
V40	.630 (16.00)
V90	1.150 (29.21)

CONTACTS

B CONTACTS: Copper alloy with gold plate, welded button.

TERMINALS: Brass with gold plate.

ELECTRICAL RATING: 0.4 VA @ 20 VAC/DC.

Q CONTACTS: Copper alloy with silver, welded button.

TERMINALS: Brass with tin/lead plate.

ELECTRICAL RATING: 5 A @ 125 VAC, 2 A @ 250 VAC, 2 A @ 30 VDC.

UL/CSA RATING: 5A @ 125 VAC, 3A @ 250 VAC. (Specify "UL" option code)

G CONTACTS: Copper alloy with gold plate over silver, welded button.

TERMINALS: Brass alloy, with gold plate.

Note: This contact option can be used for low-level or power switching. If level is above 0.4 VA @ 20 VAC/DC, the switch is rendered usable only for power switching due to arc-removal of gold plate.

UL/CSA RATING: 5A @ 125 VAC, 3A @ 250 VAC (Specify "UL" option code)

ELECTRICAL RATING: 0.4 VA @ 20 VAC/DC or 5 A @ 125 VAC, 2 A @ 250 VAC, 2 A @ 30 VDC.

Gemini Series

Toggle Switches, A Series, Vertical, Wire Lug, Long Bat Actuator

* Refer to Pages C22-C26 for Additional Options *

SEE PAGE C22 FOR PRODUCT SPECIFICATIONS

SPDT

Tyco Electronics	Alcoswitch	Type	Act. Code	P.M5			
Silver Contacts							
5-1437554-0	A101SYZQ	SPDT	1		On	None	On
7-1437554-7	A103SYZQ	SPDT	5		On	Off	On
9-1437554-6	A105SYZQ	SPDT	5		(On)	Off	(On)
1437555-9	A107SYZQ	SPDT	5		On	Off	(On)
2-1437555-0	A108SYZQ	SPDT	1		On	None	(On)
Gold Contacts							
4-1437554-9	A101SYZB	SPDT	1		On	None	On
7-1437554-6	A103SYZB	SPDT	5		On	Off	On
9-1437554-5	A105SYZB	SPDT	5		(On)	Off	(On)
	A107SYZB	SPDT	5		On	Off	(On)

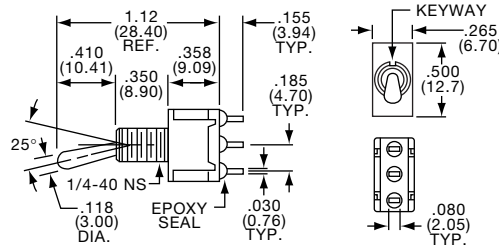

A101SYZQ

G
Gemini Series

DPDT

Tyco Electronics	Alcoswitch	Type	Act. Code	P.M5			
Silver Contacts							
4-1437555-9	A201SYZQ	DPDT	2		On	None	On
6-1437555-2	A203SYZQ	DPDT	6		On	Off	On
7-1437555-0	A205SYZQ	DPDT	6		(On)	Off	(On)
7-1437555-6	A207SYZQ	DPDT	6		On	Off	(On)
8-1437555-5	A208SYZQ	DPDT	2		On	None	(On)
1437556-1	A211SYZQ	SP3T	11		On	On	On
1437556-4	A213SYZQ	SP3T	11		On	On	(On)
1437556-7	A215SYZQ	SP3T	11		(On)	On	(On)

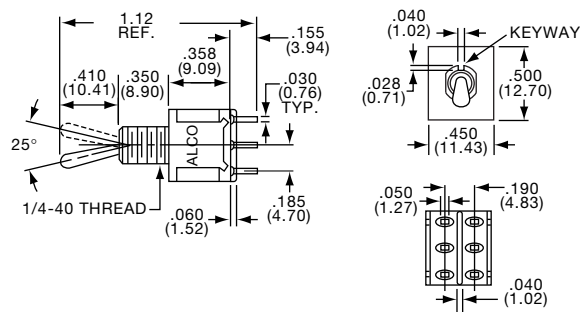

A201SYZQ

Toggle Switches, A Series, PC Terminals, Long Bat Actuators

* Refer to Pages C22-C26 for Additional Options *

SEE PAGE C22 FOR PRODUCT SPECIFICATIONS

SPDT/DPDT



A101SYAB
Horizontal Actuation

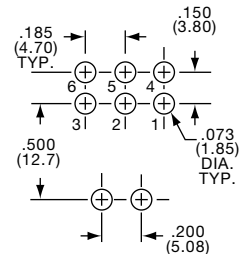
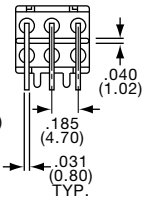
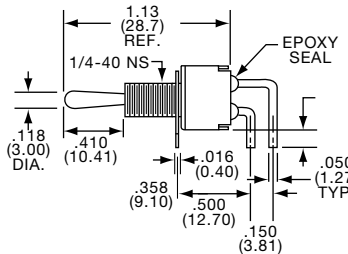
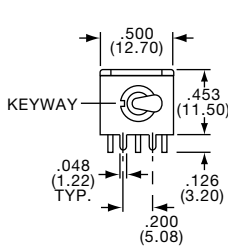
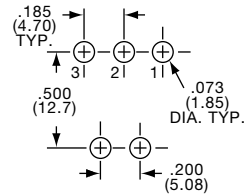
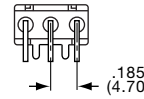
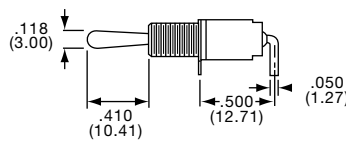
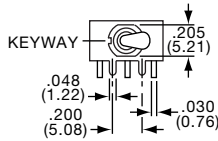

Tyco Electronics	Alcoswitch	Type	Act. Code	P.M5	↘	↓	↙
Gold Contacts							
4-1437554-3	A101SYAB	SPDT	1		On	None	On
	A103SYAB	SPDT	5		On	Off	On
4-1437555-3	A201SYAB	DPDT	2		On	None	On
	A208SYAB	DPDT	2		On	None	(On)

SPDT/DPDT



A101SYCB

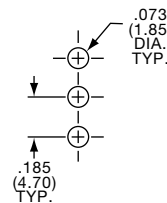
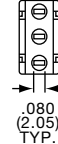
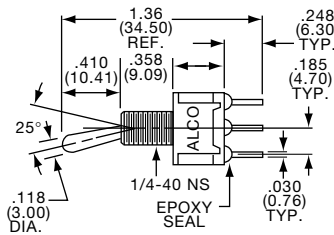
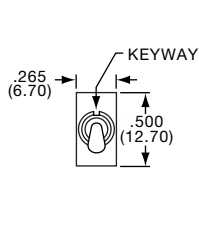

A201SYCB

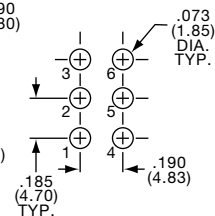
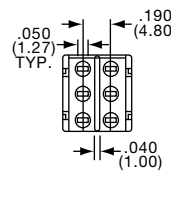
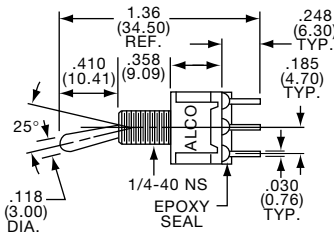
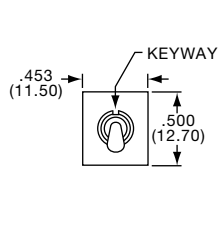

Tyco Electronics	Alcoswitch	Type	Act. Code	P.M5	↘	↓	↙
Gold Contacts							
4-1437554-5	A101SYCB	SPDT	1		On	None	On
7-1437554-2	A103SYCB	SPDT	5		On	Off	On
1-1437555-8	A108SYCB	SPDT	1		On	None	(On)
4-1437555-5	A201SYCB	DPDT	2		On	None	On
6-1437555-0	A203SYCB	DPDT	6		On	Off	On
8-1437555-3	A208SYCB	DPDT	2		On	None	(On)

Toggle Switches, A Series, Wire Wrap or Wire Lug, Long Bat Actuators

* Refer to Pages C22-C26 for Additional Options *

SEE PAGE C22 FOR PRODUCT SPECIFICATIONS

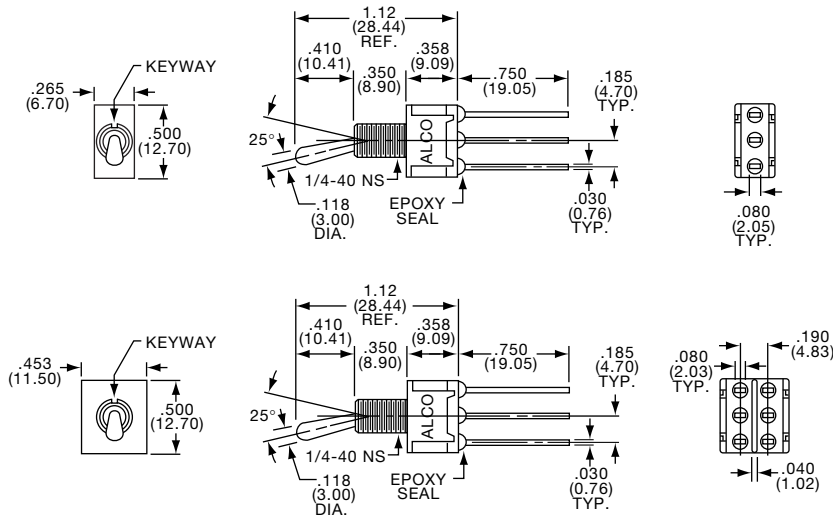

SPDT/DPDT



G
Gemini Series

Tyco Electronics	Alcoswitch	Type	Act. Code	P.M5			
Silver Contacts							
4-1437554-8	A101SYWQ	SPDT	1		On	None	On
7-1437554-5	A103SYWQ	SPDT	5		On	Off	On
4-1437555-7	A201SYWQ	DPDT	2		On	None	On
	A203SYWQ	DPDT	6		On	Off	On

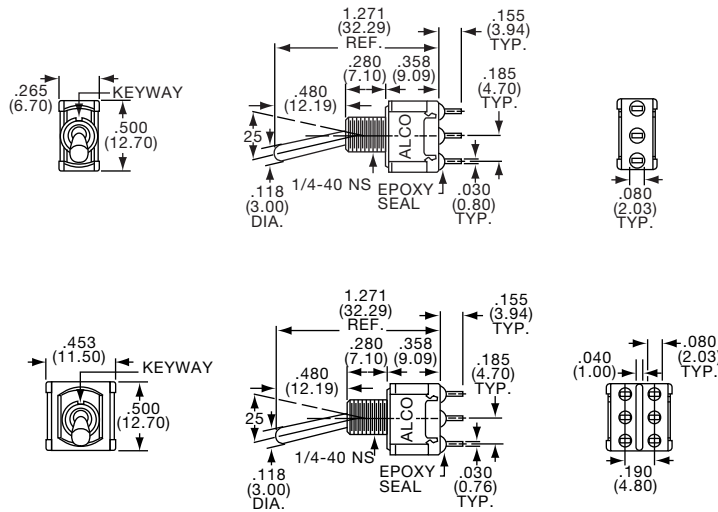

SPDT/DPDT



Tyco Electronics	Alcoswitch	Type	Act. Code	P.M5			
Silver Contacts							
4-1437554-0	A101SDZQ	SPDT	1		On	None	On
6-1437554-9	A103SDZQ	SPDT	5		On	Off	On
4-1437555-1	A201SDZQ	DPDT	2		On	None	On
5-1437555-9	A203SDZQ	DPDT	6		On	Off	On

Toggle Switches, A Series, PC Tail, Straight or Right Angle, Long Bat Actuator

* Refer to Pages C22-C26 for Additional Options *

SEE PAGE C22 FOR PRODUCT SPECIFICATIONS

SPDT



A101SDCQ

DPDT



A201SDCQ

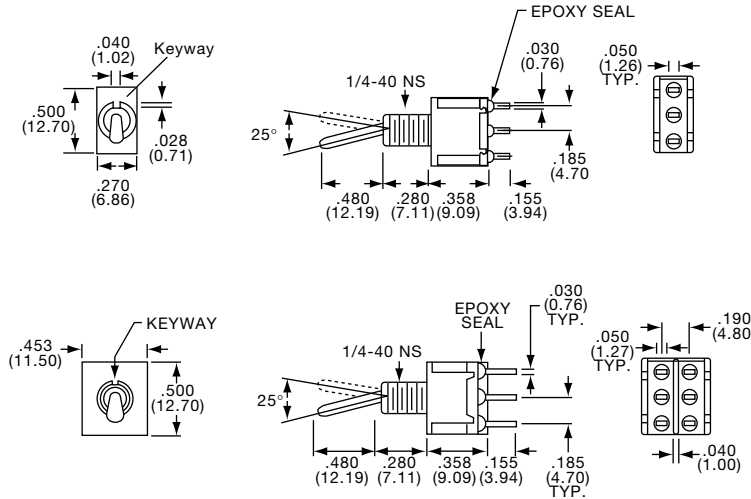

Tyco Electronics	Alcoswitch	Type	Act. Code	P.M5	↖	↓	↗
Silver Contacts							
3-1437554-9	A101SDCQ	SPDT	1		On	None	On
6-1437554-8	A103SDCQ	SPDT	5		On	Off	On
1571670-1	A201SDCQ	DPDT	2		On	None	On
	A203SDCQ	DPDT	6		On	Off	On
	A208SDCQ	DPDT	2		On	None	(On)

SPDT/DPDT



A101SD9AQ

Horizontal Actuation

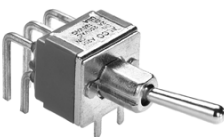
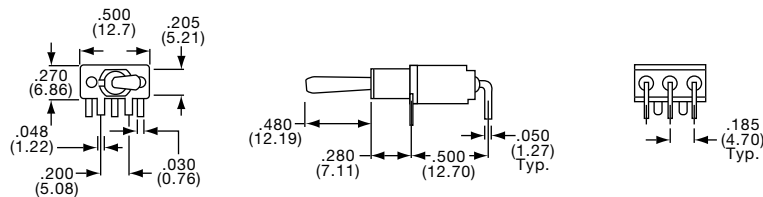

A201SD9AQ

Horizontal Actuation

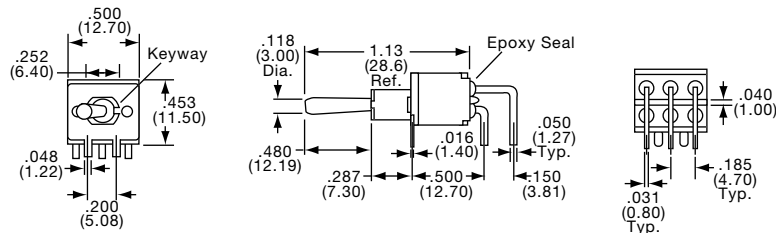

Tyco Electronics	Alcoswitch	Tyco Electronics	Alcoswitch	Type	Act. Code	P. M5	↖	↓	↗	
Silver Contacts										
3-1437554-4	A101SD9AQ	Gold Contacts		3-1437554-3	A101SD9AB	SPDT	1	On	None	On
6-1437554-4	A103SD9AQ		A103SD9AB	SPDT	5		On	Off	On	
1-1437555-6	A108SD9AQ		A108SD9AB	SPDT	1		On	None	(On)	
3-1437555-8	A201SD9AQ		A201SD9AB	DPDT	2		On	None	On	
8-1437555-1	A208SD9AQ		A208SD9AB	DPDT	2		On	None	(On)	

Toggle Switches, A Series, Vertical, Right Angle, Long Bat Actuator

* Refer to Pages C22-C26 for Additional Options *

SEE PAGE C22 FOR PRODUCT SPECIFICATIONS

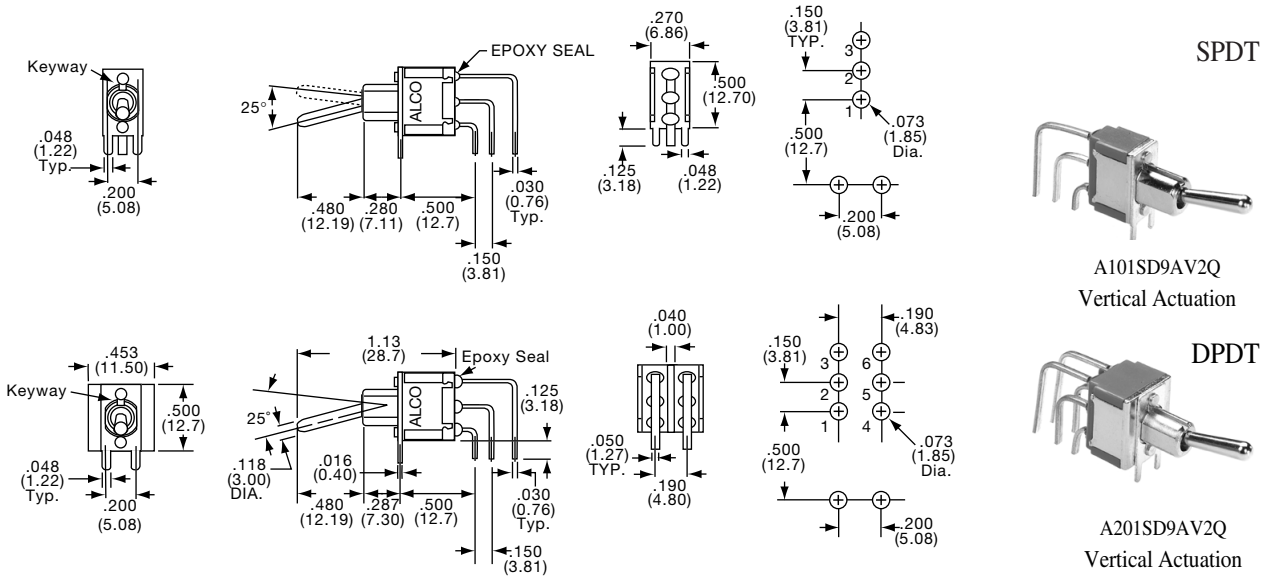

Tyco Electronics	Alcoswitch	Type	Act. Code	P.M5				Tyco Electronics	Alcoswitch	Type	Act. Code	P.M5			
Silver Contacts															
3-1437554-6	A101SD9AV2Q	SPDT	1		On	None	On	3-1437555-9	A201SD9AV2Q	DPDT	2		On	None	On
6-1437554-6	A103SD9AV2Q	SPDT	5		On	Off	On	5-1437555-8	A203SD9AV2Q	DPDT	6		On	Off	On
								8-1437555-2	A208SD9AV2Q	DPDT	2		On	None	(On)

Toggle Switches, A Series, Wire Lug, Locking Toggle

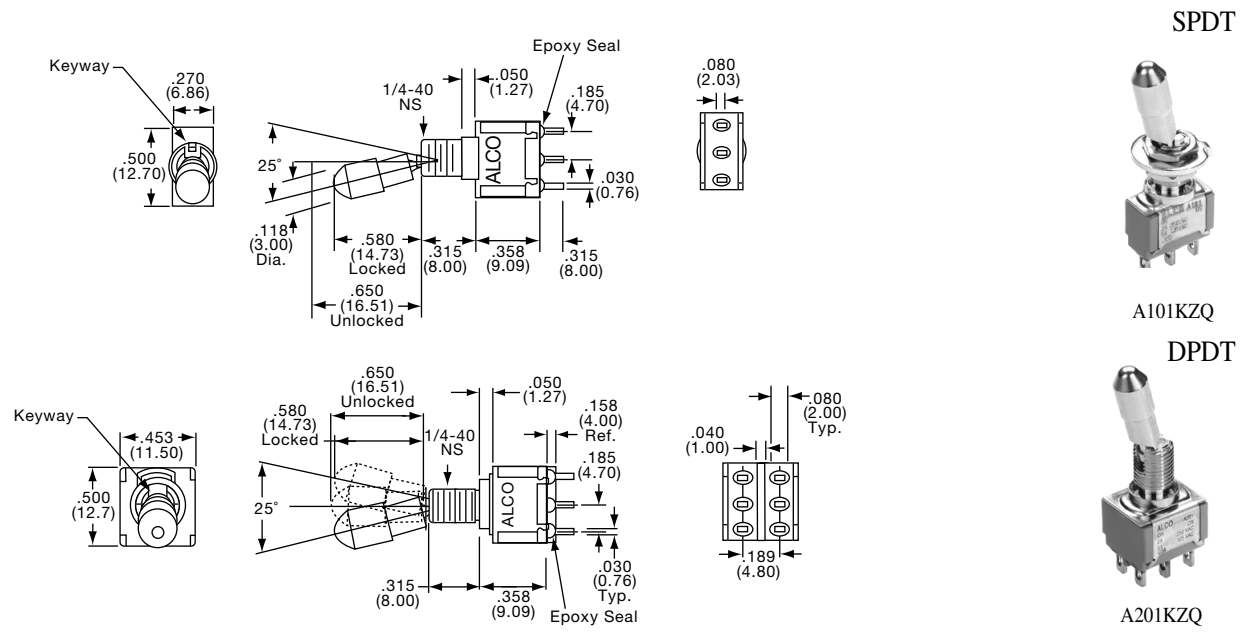

Tyco Electronics	Alcoswitch	Type	Act. Code	P.M5				Tyco Electronics	Alcoswitch	Tyco Electronics	Alcoswitch	Type	Act. Code	P.M5				
Silver Contacts																		
1437554-9	A101KZQ	SPDT	1		On	None	On	Gold Contacts		Silver Contacts		2-1437555-5	A201KZQ	DPDT	2	On	None	On
5-1437554-8	A103KZQ	SPDT	5		On	Off	On	A203KZB	A203KZB	5-1437555-3	A203KZQ	DPDT	6		On	Off	On	
								6-1437555-5	A205KZB		A205KZQ	DPDT	6		(On)	Off	(On)	
								8-1437555-8	A211KZB		A211KZQ	SP3T	11		On	On	On	

* Refer to Pages C22-C26 for Additional Options *

Toggle Switches, A Series, Right Angle, Short Bat Actuators

SEE PAGE C22 FOR PRODUCT SPECIFICATIONS

SPDT



A101MD9AQ
Horizontal Actuation

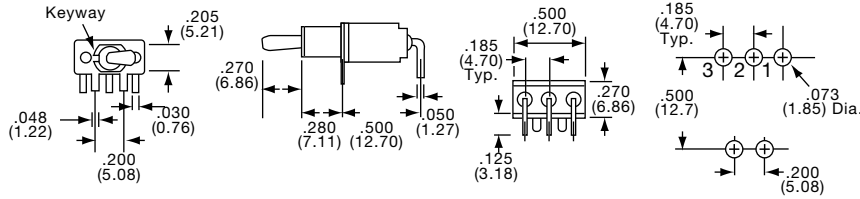

Tyco Electronics	Alcoswitch	Tyco Electronics	Alcoswitch	Type	Act. Code	P. M5			
Silver Contacts		Gold Contacts							
1-1437554-6	A101MD9AQ	1-1437554-4	A101MD9AB	SPDT	1		On	None	On
6-1437554-1	A103MD9AQ	5-1437554-9	A103MD9AB	SPDT	5		On	Off	On
	A108MD9AQ	1-1437555-2	A108MD9AB	SPDT	1		On	None	(On)

DPDT



A201MD9AQ
Horizontal Actuation

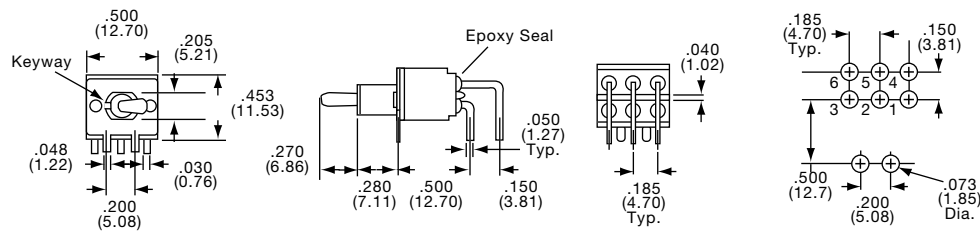

Tyco Electronics	Alcoswitch	Tyco Electronics	Alcoswitch	Type	Act. Code	P. M5			
Silver Contacts		Gold Contacts							
2-1437555-8	A201MD9AQ	2-1437555-7	A201MD9AB	DPDT	2		On	None	On
		5-1437555-4	A203MD9AB	DPDT	6		On	Off	On

SPDT



A101MD9AV2Q
Vertical Actuation

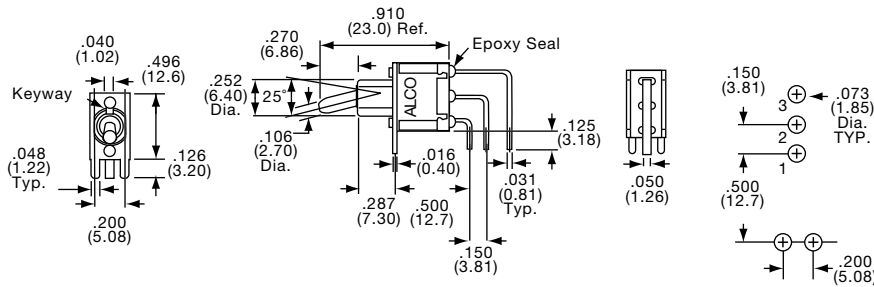

Tyco Electronics	Alcoswitch	Tyco Electronics	Alcoswitch	Type	Act. Code	P. M5			
Silver Contacts		Gold Contacts							
1-1437554-9	A101MD9AV2Q	1-1437554-7	A101MD9AV2B	SPDT	1		On	None	On
	A103MD9AV2Q	6-1437554-2	A103MD9AV2B	SPDT	5		On	Off	On
	A108MD9AV2Q			SPDT	1		On	None	(On)

DPDT

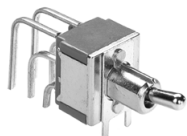

A201MD9AV2AQ
Vertical Actuation

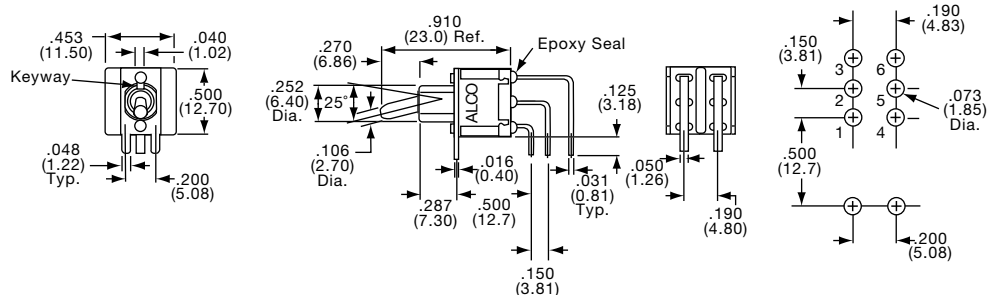

Tyco Electronics	Alcoswitch	Tyco Electronics	Alcoswitch	Type	Act. Code	P. M5			
Silver Contacts		Gold Contacts							
3-1437555-0	A201MD9AV2Q	2-1437555-9	A201MD9AV2B	DPDT	2		On	None	On
	A203MD9AV2Q		A203MD9AV2B	DPDT	6		On	Off	On
	A208MD9AV2Q		A208MD9AV2B	DPDT	2		On	None	(On)

Toggle Switches, A Series, Vertical, Wire Lug, Flat or Long Bat Actuator

* Refer to Pages C22-C26 for Additional Options *

SEE PAGE C22 FOR PRODUCT SPECIFICATIONS

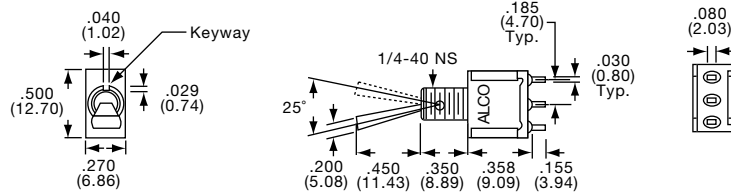

SPDT



A101P3YZQ

Tyco Electronics	Alcoswitch	Type	Act. Code	P.M5	↖	⬇	↗
Silver Contacts							
2-1437554-9	A101P3YZQ	SPDT	1		On	None	On
6-1437554-3	A103P3YZQ	SPDT	5		On	Off	On
8-1437554-7	A105P3YZQ	SPDT	5		(On)	Off	(On)
1437555-5	A107P3YZQ	SPDT	5		On	Off	(On)
1-1437555-5	A108P3YZQ	SPDT	1		On	None	(On)

Tyco Electronics	Alcoswitch	Type	Act. Code	P.M5	↖	⬇	↗
Silver Contacts							
3-1437555-6	A201P3YZQ	DPDT	2		On	None	On
5-1437555-6	A203P3YZQ	DPDT	6		On	Off	On
6-1437555-6	A205P3YZQ	DPDT	6		(On)	Off	(On)
7-1437555-3	A207P3YZQ	DPDT	6		On	Off	(On)
8-1437555-0	A208P3YZQ	DPDT	2		On	None	(On)
9-1436555-3	A211P3YZQ	SP3T	11		On	On	On
	A215P3YZQ	SP3T	11		(On)	On	(On)

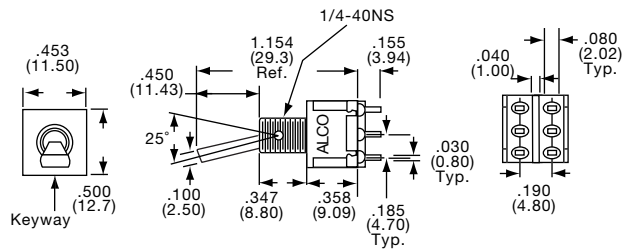

DPDT



A201P3YZQ

Tyco Electronics	Alcoswitch	Type	Act. Code	P.M5	↖	⬇	↗
Silver Contacts							
5-1437554-6	A101TZQ	SPDT	1		On	None	On
8-1437554-0	A103TZQ	SPDT	5		On	Off	On

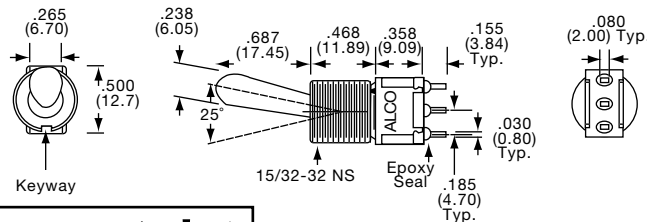

SPDT



A101TZQ

Tyco Electronics	Alcoswitch	Type	Act. Code	P.M5	↖	⬇	↗
Silver Contacts							
5-1437555-2	A201TZQ	DPDT	2		On	None	On
6-1437555-4	A203TZQ	DPDT	6		On	Off	On
	A211TZQ	SP3T	11		On	On	On

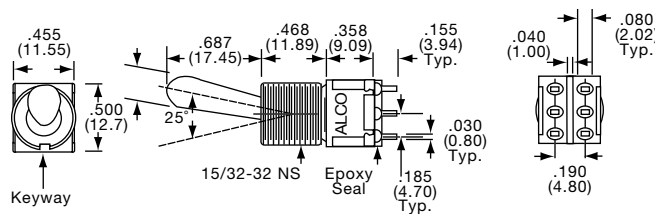

DPDT



A201TZQ

Toggle Switches, A Series, Wire Lug, 15/32 Bushing, Short Bat Actuator

* Refer to Pages C22-C26 for Additional Options *

SEE PAGE C22 FOR PRODUCT SPECIFICATIONS

SPDT



A103T1ZQ

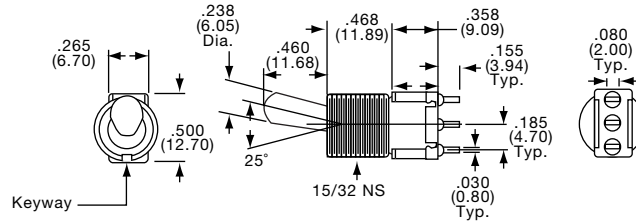

Tyco Electronics	Alcoswitch	Type	Act. Code	P.M5	↘	↓	↙
Silver Contacts							
5-1437554-4	A101T1ZQ	SPDT	1		On	None	On
7-1437554-9	A103T1ZQ	SPDT	5		On	Off	On
9-1437554-8	A105T1ZQ	SPDT	5		(On)	Off	(On)
	A108T1ZQ	SPDT	1		On	None	(On)

DPDT



A201T1ZQ

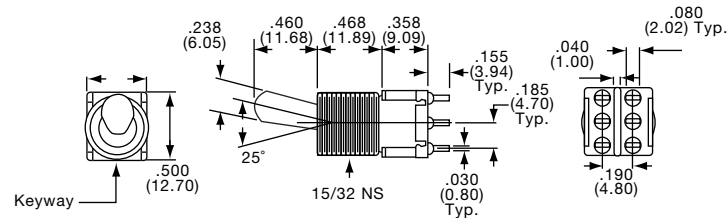

Tyco Electronics	Alcoswitch	Type	Act. Code	P.M5	↘	↓	↙
Silver Contacts							
5-1437555-0	A201T1ZQ	DPDT	2		On	None	On
6-1437555-3	A203T1ZQ	DPDT	6		On	Off	On
7-1437555-1	A205T1ZQ	DPDT	6		(On)	Off	(On)
7-1437555-7	A207T1ZQ	DPDT	6		On	Off	(On)
8-1437555-6	A208T1ZQ	DPDT	2		On	None	(On)
1437556-2	A211T1ZQ	SP3T	11		On	On	On