

1.5KE6V8(C)A - 1.5KE550(C)A

Features

- 1500W Peak Pulse Power Dissipation
- Voltage Range 6.8V - 550V
- Constructed with Glass Passivated Die
- Uni- and Bidirectional Versions Available
- Excellent Clamping Capability
- Fast Response Time

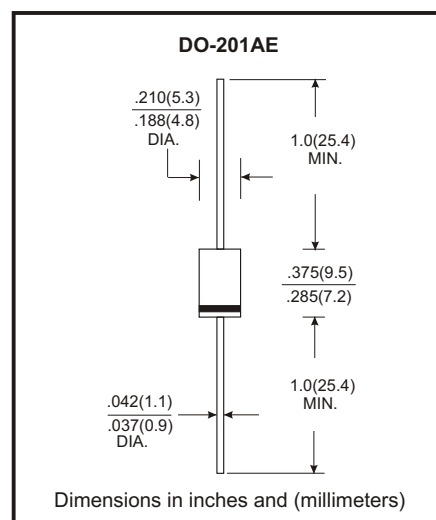

Absolute Maximum Ratings Ta = 25

Parameter	Symbol	Rating	Unit
Peak Power Dissipation, tp = 1.0 ms	PPPM	1500	W
Steady State Power Dissipation at TL = 75 °C Lead Lengths 9.5 mm (Mounted on Copper Land Area of 20mm ²)	PD	6.5	W
Peak Forward Surge Current, 8.3 ms Single Half Sine Wave, Superimposed on Rated Load (JEDEC Method)	IFSM	200	A
Maximum Instantaneous Forward Voltage at 100A for Unidirectional only	VF	3.5/5.0	V
Typical Thermal Resistance Junction to Lead	RUJL	15	/W
Typical Thermal Resistance Junction to Ambient	RUJA	75	/W
Operating and Storage Temperature Range	TJ, TSTG	-55 to +175	



1.5KE6V8(C)A - 1.5KE550(C)A

Electrical Characteristics Ta = 25

Type Number	Type Number	Reverse Standoff Voltage	Breakdown Voltage VBR @ IT		Test Current	Max Reverse Leakage @ VR	Max Clamping Voltage @ Ipp	Max Peak Pulse Current
			Min(V)	Max(V)				
(Uni)	(BI)	VRWM(V)	Min(V)	Max(V)	IT(mA)	IR(μA)	VC(V)	IPP(A)
1.5KE6V8A	1.5KE6V8CA	5.8	6.45	7.14	10	1000	10.5	144.8
1.5KE7V5A	1.5KE7V5CA	6.4	7.13	7.88	10	500	11.3	134.5
1.5KE8V2A	1.5KE8V2CA	7.02	7.79	8.61	10	200	12.1	125.6
1.5KE9V1A	1.5KE9V1CA	7.78	8.65	9.5	1	50	13.4	113.4
1.5KE10A	1.5KE10CA	8.55	9.5	10.5	1	10	14.5	104.8
1.5KE11A	1.5KE11CA	9.4	10.5	11.6	1	5	15.6	97.4
1.5KE12A	1.5KE12CA	10.2	11.4	12.6	1	5	16.7	91
1.5KE13A	1.5KE13CA	11.1	12.4	13.7	1	1	18.2	83.5
1.5KE15A	1.5KE15CA	12.8	14.3	15.8	1	1	21.2	71.7
1.5KE16A	1.5KE16CA	13.6	15.2	16.8	1	1	22.5	67.6
1.5KE18A	1.5KE18CA	15.3	17.1	18.9	1	1	25.2	60.3
1.5KE20A	1.5KE20CA	17.1	19	21	1	1	27.7	54.9
1.5KE22A	1.5KE22CA	18.8	20.9	23.1	1	1	30.6	49.7
1.5KE24A	1.5KE24CA	20.5	22.8	25.2	1	1	33.2	45.8
1.5KE27A	1.5KE27CA	23.1	25.7	28.4	1	1	37.5	40.5
1.5KE30A	1.5KE30CA	25.6	28.5	31.5	1	1	41.4	36.7
1.5KE33A	1.5KE33CA	28.2	31.4	34.7	1	1	45.7	33.3
1.5KE36A	1.5KE36CA	30.8	34.2	37.8	1	1	49.9	30.5
1.5KE39A	1.5KE39CA	33.3	37.1	41	1	1	53.9	28.2
1.5KE43A	1.5KE43CA	36.8	40.9	45.2	1	1	59.3	25.6
1.5KE47A	1.5KE47CA	40.2	44.7	49.4	1	1	64.8	23.5
1.5KE51A	1.5KE51CA	43.6	48.5	53.6	1	1	70.1	21.7
1.5KE56A	1.5KE56CA	47.8	53.2	58.8	1	1	77	19.7
1.5KE62A	1.5KE62CA	53	58.9	65.1	1	1	85	17.9
1.5KE68A	1.5KE68CA	58.1	64.6	71.4	1	1	92	16.5
1.5KE75A	1.5KE75CA	64.1	71.3	78.8	1	1	103	14.8
1.5KE82A	1.5KE82CA	70.1	77.9	86.1	1	1	113	13.5
1.5KE91A	1.5KE91CA	77.8	86.5	95.5	1	1	125	12.2
1.5KE100A	1.5KE100CA	85.5	95	105	1	1	137	11.1
1.5KE110A	1.5KE110CA	94	105	116	1	1	152	10
1.5KE120A	1.5KE120CA	102	114	126	1	1	165	9.2
1.5KE130A	1.5KE130CA	111	124	137	1	1	179	8.5
1.5KE150A	1.5KE150CA	128	143	158	1	1	207	7.3
1.5KE160A	1.5KE160CA	136	152	168	1	1	219	6.9
1.5KE170A	1.5KE170CA	145	162	179	1	1	234	6.5
1.5KE180A	1.5KE180CA	154	171	189	1	1	246	6.2
1.5KE200A	1.5KE200CA	171	190	210	1	1	274	5.5
1.5KE220A	1.5KE220CA	185	209	231	1	1	328	4.6
1.5KE250A	1.5KE250CA	214	237	263	1	1	344	4.4
1.5KE300A	1.5KE300CA	256	285	315	1	1	414	3.7
1.5KE350A	1.5KE350CA	300	332	368	1	1	482	3.2
1.5KE400A	1.5KE400CA	342	380	420	1	1	548	2.8
1.5KE440A	1.5KE440CA	376	418	462	1	1	602	2.5
1.5KE480A	1.5KE480CA	408	456	504	1	1	658	2.3
1.5KE510A	1.5KE510CA	434	485	535	1	1	698	2.1
1.5KE530A	1.5KE530CA	477	503.5	556.5	1	1	725	2.1
1.5KE540A	1.5KE540CA	459	513	567	1	1	740	2
1.5KE550A	1.5KE550CA	495	522.5	577.5	1	1	760	2

1.5KE6V8(C)A - 1.5KE550(C)A

■ Typical Characteristics

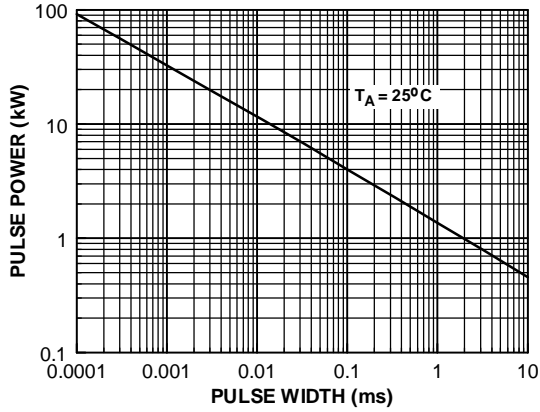

Peak Pulse Power Rating Curve

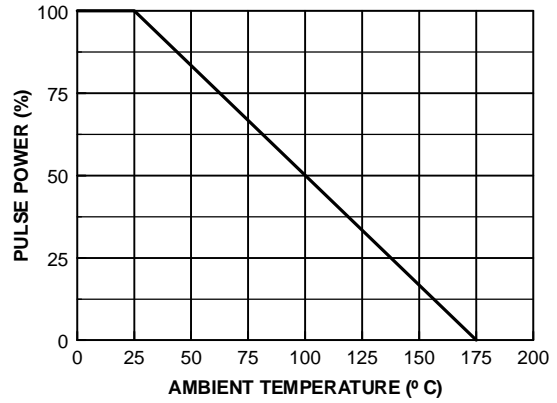

Pulse Derating Curve

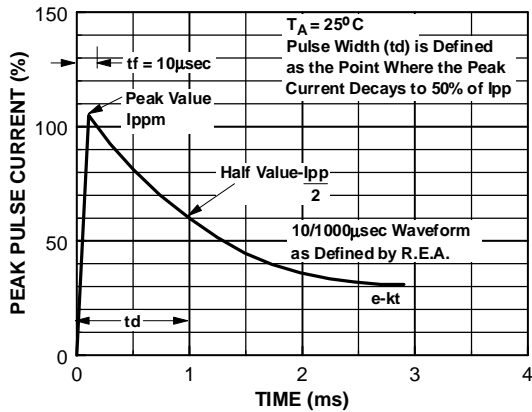

Pulse Waveform

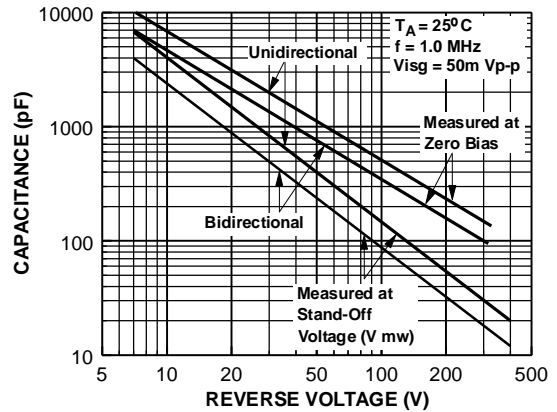

Junction Capacitance

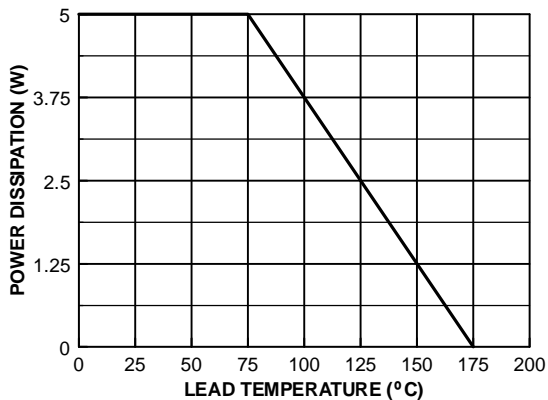

Steady State Power Derating Curve

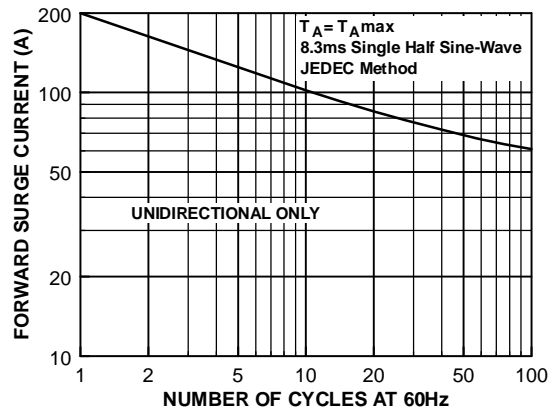

Non-Repetitive Surge Current