



Unidirectional and Bidirectional Transient Voltage Suppressors

Reverse Voltage 6.8 - 400 Volts

Power Dissipation - 1500 Watts

Features

- low leakage
- Uni and bidirectional unit
- Excellent clamping capability
- Fast response time

Mechanical Data

- Case: DO-201AE molded plastic

- Polarity: Color band denotes cathode

Note: Products with logo  or  are made by HY Electronic (Cayman) Limited.

Applications

- Use in sensitive electronics protection against voltage transients induced by inductive load switching and lighting on ICs, MOSFET.

DO-201AE

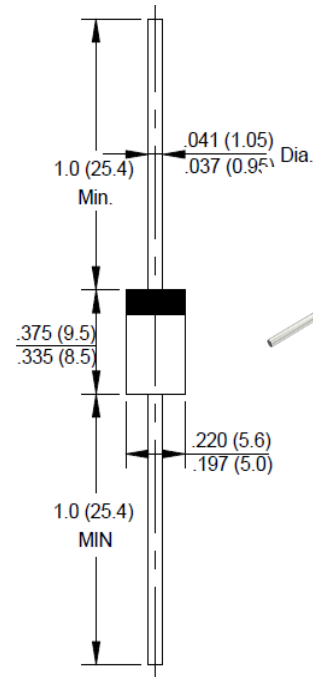

RoHS COMPLIANT



Package Outline Dimensions in Inches (Millimeters)

Maximum Ratings and Electrical Characteristics

Rating at 25°C ambient temperature unless otherwise specified.

Single phase, half wave, 60Hz, resistive or inductive load.

For capacitive load, derate current by 20%.

Characteristics	Symbol	Value	Unit
Peak Power Dissipation at $T_A=25^\circ\text{C}$ $T_P=1\text{ms}$ (Note 1)	P_{PK}	1500 (Min)	W
Peak Forward Surge Current, 8.3ms Single Half Sine-Wave, Superimposed on Rated Load (JEDEC Method)	I_{FSM}	200	A
Steady State Power Dissipation at $T_L=75^\circ\text{C}$ Lead Lengths 0.375"(9.5mm), See Fig. 6	$P_{M(AV)}$	5	W
Maximum Instantaneous Forward Voltage at 50A for Unidirectional Devices Only (Note 2)	V_F	See Note 3	$^\circ\text{C/W}$
Operating Junction Temperature Range	T_J	-55 to + 150	$^\circ\text{C}$
Storage Temperature Range	T_{STG}	-55 to + 175	$^\circ\text{C}$

Notes: 1. Non-repetitive current pulse, per Fig. 3 and derated above $T_A=25^\circ\text{C}$ per Fig. 1.

2. 8.3ms single half-wave duty cycle=4 pulses per minutes maximum (uni-directional units only).

3. $V_F=3.5\text{V}$ on 1.5KE6.8G thru 1.5KE200AG devices and $V_F=5.0\text{V}$ on 1.5KE220G thru 1.5KE400AG devices.



Fig. 1 - Maximum Non-Repetitive Peak Forward Surge Current

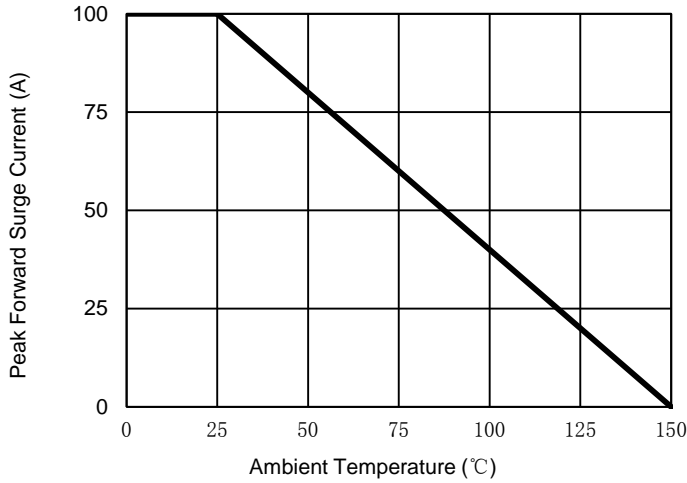

Fig. 2 - Maximum Non-Repetitive Surge Current

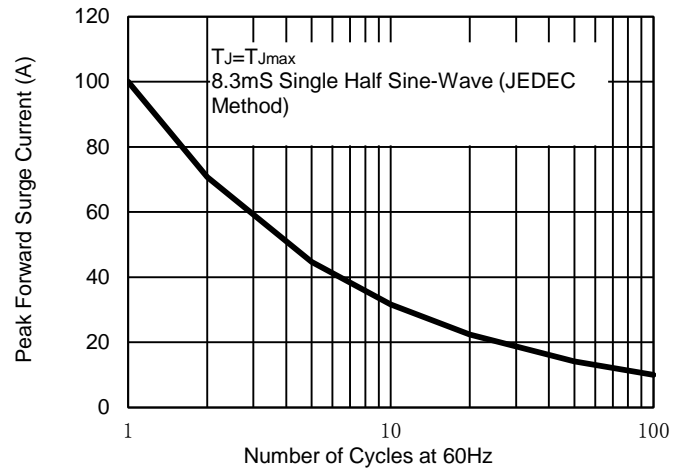

Fig. 3 - Pulse Waveform

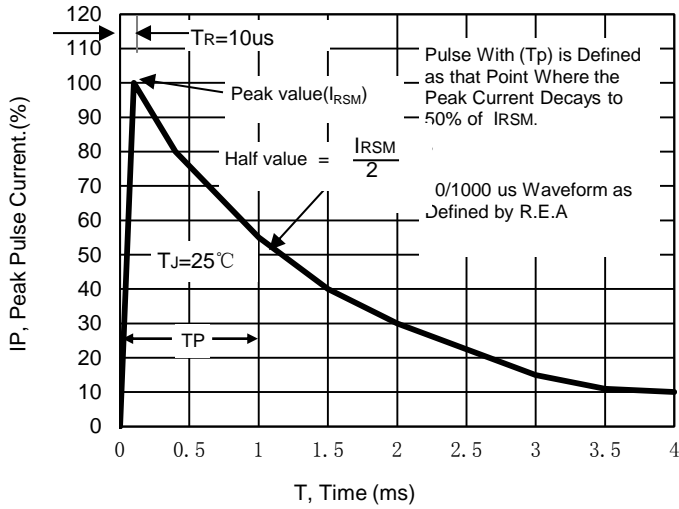

Fig. 4- Typical Junction Capacitance

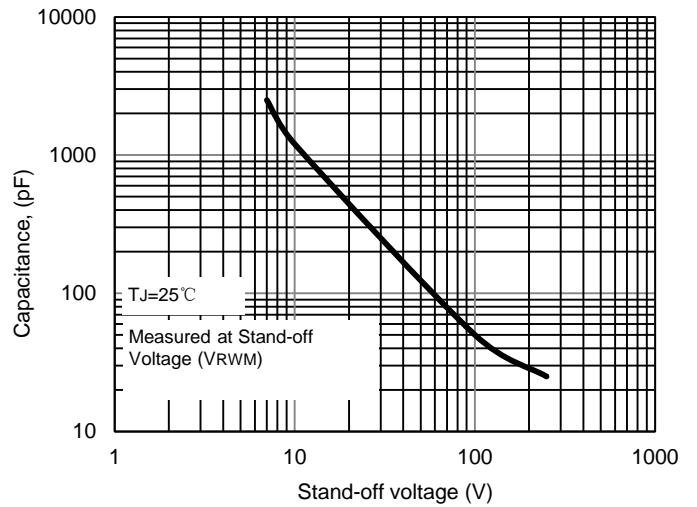

Fig. 5 - Pulse Rating Curve

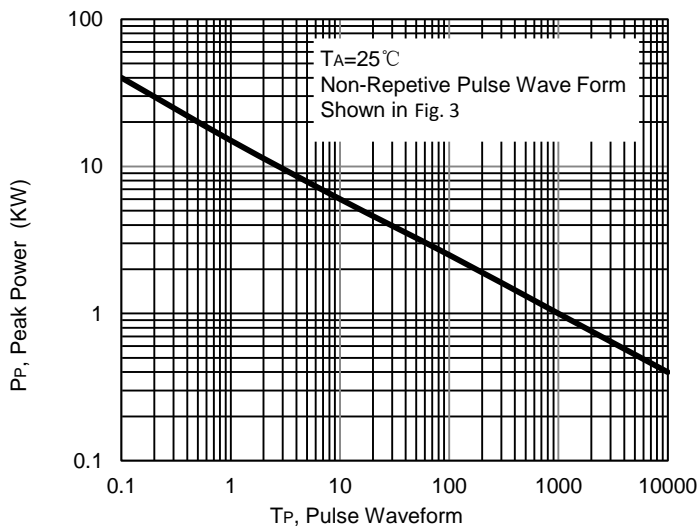
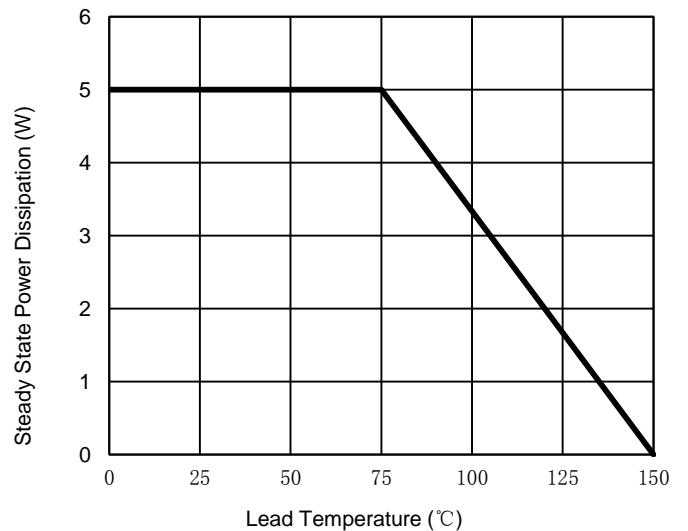

Fig. 6 - Steady State Power Derating Curve



The curve above is for reference only.

1P5KEG*-A/T-00/99-00/01

Rev. 11, 18-May-2020



1.5KEG SERIES

Device Uni-directional	Device Bi-directional	Reverse Stand off Voltage	Breakdown Voltage at IT2 V(BR) (V)			Maximum Reverse Leakage at VR	Maximum Clamping Voltage at IPPM	Maximum Peak Pulse Surge Current ⁽³⁾	Max. Voltage Temp.
			Min(V)	Max(V)	It(mA)				
(UNI)	(BI)	VR(V)	Min(V)	Max(V)	It(mA)	IR(μA)	Vc(V)	Ipp(A)	mV/°C
1.5KEG6.8A	1.5KEG6.8CA	5.80	6.45	7.14	10	1000	10.5	143.0	0.057
1.5KEG7.5A	1.5KEG7.5CA	6.40	7.13	7.88	10	500	11.3	132.0	0.061
1.5KEG8.2A	1.5KEG8.2CA	7.02	7.79	8.61	10	200	12.1	124.0	0.065
1.5KEG9.1A	1.5KEG9.1CA	7.78	8.65	9.55	1	50	13.4	112.0	0.068
1.5KEG10A	1.5KEG10CA	8.55	9.50	10.50	1	10	14.5	103.0	0.073
1.5KEG11A	1.5KEG11CA	9.40	10.50	11.60	1	5	15.6	96.0	0.075
1.5KEG12A	1.5KEG12CA	10.20	11.40	12.60	1	5	16.7	90.0	0.078
1.5KEG13A	1.5KEG13CA	11.10	12.40	13.70	1	5	18.2	82.0	0.081
1.5KEG15A	1.5KEG15CA	12.80	14.30	15.80	1	5	21.2	71.0	0.084
1.5KEG16A	1.5KEG16CA	13.60	15.20	16.80	1	5	22.5	67.0	0.086
1.5KEG18A	1.5KEG18CA	15.30	17.10	18.90	1	5	25.2	59.5	0.088
1.5KEG20A	1.5KEG20CA	17.10	19.00	21.00	1	5	27.7	54.0	0.090
1.5KEG22A	1.5KEG22CA	18.80	20.90	23.10	1	5	30.6	49.0	0.092
1.5KEG24A	1.5KEG24CA	20.50	22.80	25.20	1	5	33.2	45.0	0.094
1.5KEG27A	1.5KEG27CA	23.10	25.70	28.40	1	5	37.5	40.0	0.096
1.5KEG30A	1.5KEG30CA	25.60	28.50	31.50	1	5	41.4	36.0	0.097
1.5KEG33A	1.5KEG33CA	28.20	31.40	34.70	1	5	45.7	33.0	0.098
1.5KEG36A	1.5KEG36CA	30.80	34.20	37.80	1	5	49.9	30.0	0.099
1.5KEG39A	1.5KEG39CA	33.30	37.10	41.00	1	5	53.9	28.0	0.100
1.5KEG43A	1.5KEG43CA	36.80	40.90	45.20	1	5	59.3	25.3	0.101
1.5KEG47A	1.5KEG47CA	40.20	44.70	49.40	1	5	64.8	23.2	0.101
1.5KEG51A	1.5KEG51CA	43.60	48.50	53.60	1	5	70.1	21.4	0.102
1.5KEG56A	1.5KEG56CA	47.80	53.20	58.80	1	5	77.0	19.5	0.103
1.5KEG62A	1.5KEG62CA	53.0	58.9	65.1	1	5	85.0	17.70	0.104
1.5KEG68A	1.5KEG68CA	58.1	64.6	71.4	1	5	92.0	16.30	0.104
1.5KEG75A	1.5KEG75CA	64.7	71.3	78.8	1	5	103.0	14.60	0.105
1.5KEG82A	1.5KEG82CA	70.1	77.9	86.1	1	5	113.0	13.30	0.105
1.5KEG91A	1.5KEG91CA	77.8	86.5	95.5	1	5	125.0	12.00	0.106
1.5KEG100A	1.5KEG100CA	85.5	95.0	105.0	1	5	137.0	11.00	0.106
1.5KEG110A	1.5KEG110CA	94.0	105.0	116.0	1	5	152.0	9.90	0.107
1.5KEG120A	1.5KEG120CA	102.0	114.0	126.0	1	5	165.0	9.10	0.107
1.5KEG130A	1.5KEG130CA	111.0	124.0	137.0	1	5	179.0	8.40	0.107
1.5KEG150A	1.5KEG150CA	128.0	143.0	158.0	1	5	207.0	7.20	0.108
1.5KEG160A	1.5KEG160CA	136.0	152.0	168.0	1	5	219.0	6.80	0.108
1.5KEG170A	1.5KEG170CA	145.0	162.0	179.0	1	5	234.0	6.40	0.108
1.5KEG180A	1.5KEG180CA	154.0	171.0	189.0	1	5	246.0	6.10	0.108
1.5KEG200A	1.5KEG200CA	171.0	190.0	210.0	1	5	274.0	5.50	0.108
1.5KEG220A	1.5KEG220CA	185.0	209.0	231.0	1	5	328.0	4.60	0.108
1.5KEG250A	1.5KEG250CA	214.0	237.0	263.0	1	5	344.4	5.00	0.110
1.5KEG300A	1.5KEG300CA	256.0	285.0	315.0	1	5	414.0	5.00	0.110
1.5KEG350A	1.5KEG350CA	300.0	332.0	368.0	1	5	482.0	4.00	0.110
1.5KEG400A	1.5KEG400CA	342.0	380.0	420.0	1	5	548.0	4.00	0.110

Notes: 1. Suffix 'C' denotes bidirectional device. Suffix 'A' denotes 5% tolerance device

2. For bidirectional devices having VR of 10volts and under, the IR limit is doubled.

1P5KEG*-A/T-00/99-00/01

Rev. 11, 18-May-2020



Disclaimer

ALL specifications and data are subject to be changed without notice to improve reliability function or design or other reasons.

HY makes no warranty, representation or guarantee regarding the suitability of the products for any particular purpose or the continuing production of any product. To the maximum extent permitted by applicable law, HY disclaims (i) any and all liability arising out of the application or use of any product, (ii) any and all liability, including without limitation special, consequential or incidental damages, and (iii) any and all implied warranties, including warranties of fitness for particular purpose, non-infringement and merchantability.

Statements regarding the suitability of products for certain types of applications are based on HY's knowledge of typical requirements that are often placed on HY products in generic applications. Such statements are not binding statements about the suitability of products for a particular application. It is the customer's responsibility to validate that a particular product with the properties described in the product specification is suitable for use in a particular application. Parameters provided in datasheets and specifications may vary in different applications and performance may vary over time. All operating parameters, including typical parameters, must be validated for each customer application by the customer's technical experts. Product specifications do not expand or otherwise modify HY's terms and conditions of purchase, including but not limited to the warranty expressed therein.

Except as expressly indicated in writing, HY products are not designed for use in medical, life-saving, or life-sustaining applications or for any other applications in which the failure of the HY product could result in personal injury or death. Customers using or selling HY products not expressly indicated for use in such applications do so at their own risk. Please contact authorized HY personnel to obtain written terms and conditions regarding products designed for such applications.

No license, express or implied, by estoppel or otherwise, to any intellectual property rights is granted by this document or by any conduct of HY. Product names and markings noted herein may be trademarks of their respective owners.