



10CTQ150SPbF 10CTQ150-1PbF

SCHOTTKY RECTIFIER

10 Amp

$I_{F(AV)} = 10\text{Amp}$
 $V_R = 150\text{V}$

Major Ratings and Characteristics

Characteristics	Values	Units
$I_{F(AV)}$ Rectangular waveform	10	A
V_{RRM}	150	V
I_{FSM} @ tp = 5 μ s sine	620	A
V_F @ 5 Apk, $T_J = 125^\circ\text{C}$ (per leg)	0.73	V
T_J range	-55 to 175	$^\circ\text{C}$

Description/ Features

This center tap Schottky ectifier has been optimized for low reverse leakage at high temperature. The proprietary barrier technology allows for reliable operation up to 175° C junction temperature. Typical applications are in switching power supplies, converters, free-wheeling diodes, and reverse battery protection.

- 175° C T_J operation
- Center tap configuration
- Low forward voltage drop
- High purity, high temperature epoxy encapsulation for enhanced mechanical strength and moisture resistance
- High frequency operation
- Guard ring for enhanced ruggedness and long term reliability
- Lead-Free ("PbF" suffix)

Case Styles

10CTQ150SPbF

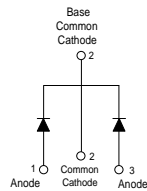

D²PAK

10CTQ150-1PbF

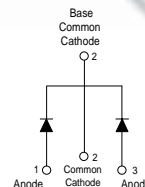

TO-262

Voltage Ratings

Parameters	10CTQ150SPbF, 10CTQ150-1PbF
V_R Max. DC Reverse Voltage (V)	150
V_{RWM} Max. Working Peak Reverse Voltage (V)	

Absolute Maximum Ratings

Parameters	Values	Units	Conditions
$I_{F(AV)}$ Max. Average Forward (Per Leg) Current * See Fig. 5 (Per Device)	5	A	50% duty cycle @ $T_C = 155^\circ\text{C}$, rectangular wave form
	10		
I_{FSM} Max. Peak One Cycle Non-Repetitive Surge Current (Per Leg) * See Fig. 7	620	A	5 μs Sine or 3 μs Rect. pulse
	115		10ms Sine or 6ms Rect. pulse
E_{AS} Non-Repetitive Avalanche Energy (Per Leg)	6.75	mJ	$T_J = 25^\circ\text{C}$, $I_{AS} = 0.30$ Amps, $L = 150$ mH
I_{AR} Repetitive Avalanche Current (Per Leg)	0.30	A	Current decaying linearly to zero in 1 μsec Frequency limited by T_J max. $V_A = 1.5 \times V_R$ typical

Electrical Specifications

Parameters	Values	Units	Conditions
V_{FM} Max. Forward Voltage Drop (Per Leg) * See Fig. 1 (1)	0.93	V	@ 5A
	1.10	V	@ 10A
	0.73	V	@ 5A
	0.86	V	@ 10A
I_{RM} Max. Reverse Leakage Current (Per Leg) * See Fig. 2 (1)	0.05	mA	$T_J = 25^\circ\text{C}$
	7	mA	$T_J = 125^\circ\text{C}$
$V_{F(TO)}$ Threshold Voltage	0.468	V	$T_J = T_J$ max.
r_t Forward Slope Resistance	28	m Ω	
C_T Max. Junction Capacitance (Per Leg)	200	pF	$V_R = 5V_{DC}$ (test signal range 100Khz to 1Mhz) 25°C
L_S Typical Series Inductance (Per Leg)	8.0	nH	Measured lead to lead 5mm from package body
dv/dt Max. Voltage Rate of Change	10000	V/ μs	(Rated V_R)

(1) Pulse Width < 300 μs , Duty Cycle < 2%

Thermal-Mechanical Specifications

Parameters	Values	Units	Conditions
T_J Max. Junction Temperature Range	-55 to 175	$^\circ\text{C}$	
T_{stg} Max. Storage Temperature Range	-55 to 175	$^\circ\text{C}$	
R_{thJC} Max. Thermal Resistance Junction to Case (Per Leg)	3.50	$^\circ\text{C}/\text{W}$	DC operation
R_{thJC} Max. Thermal Resistance Junction to Case (Per Package)	1.75	$^\circ\text{C}/\text{W}$	DC operation
R_{thCS} Typical Thermal Resistance, Case to Heatsink (only for TO-220)	0.50	$^\circ\text{C}/\text{W}$	Mounting surface, smooth and greased
wt Approximate Weight	2 (0.07)	g (oz.)	
T Mounting Torque	Min.	6 (5)	Kg-cm (lbf-in)
	Max.	12 (10)	
Marking Device	10CTQ150S	Case style D ² Pak	
	10CTQ150-1	Case style TO-262	

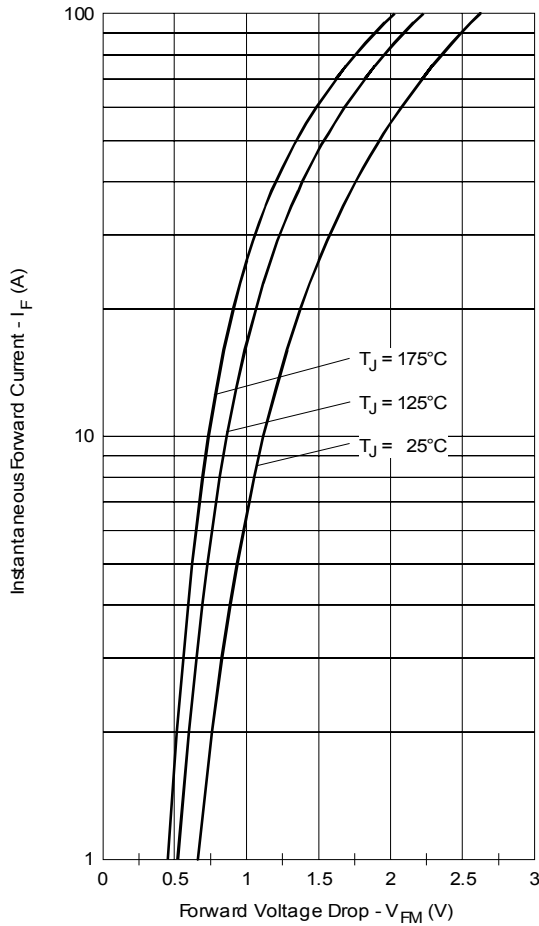

Fig. 1 - Max. Forward Voltage Drop Characteristics (Per Leg)

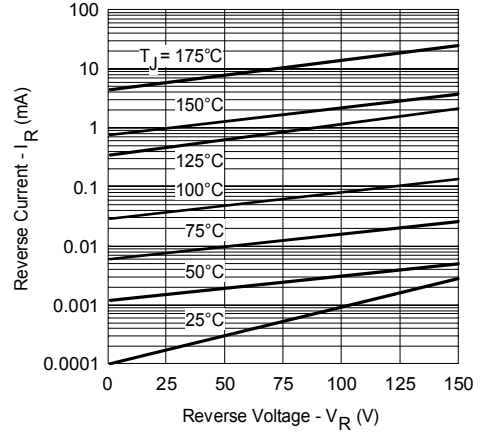

Fig. 2 - Typical Values Of Reverse Current Vs. Reverse Voltage (Per Leg)

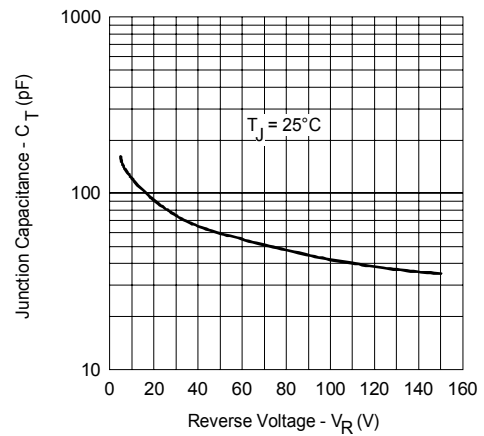

Fig. 3 - Typical Junction Capacitance Vs. Reverse Voltage (Per Leg)

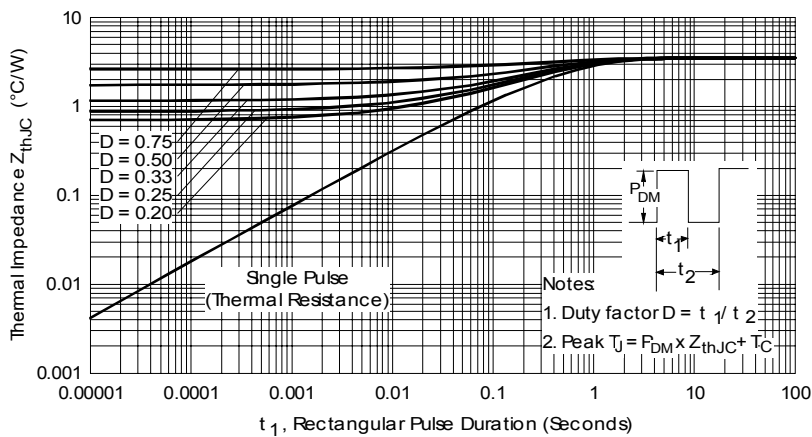

Fig. 4 - Max. Thermal Impedance Z_{thJC} Characteristics (Per Leg)

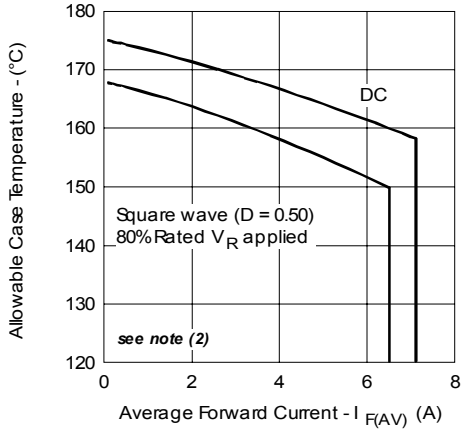

Fig. 5 - Max. Allowable Case Temperature Vs. Average Forward Current (Per Leg)

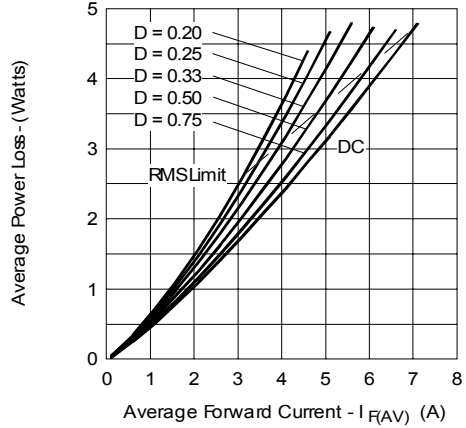

Fig. 6 - Forward Power Loss Characteristics (Per Leg)

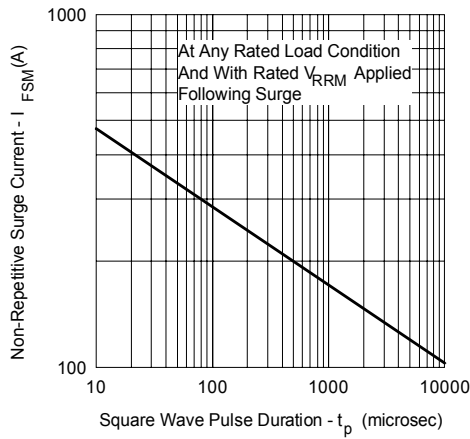

Fig. 7 - Max. Non-Repetitive Surge Current (Per Leg)

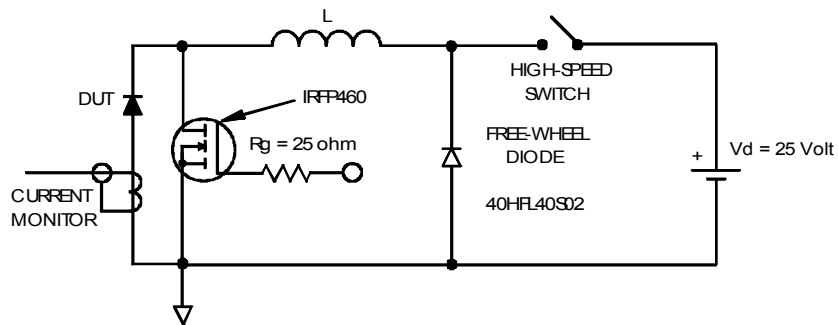

Fig. 8 - Unclamped Inductive Test Circuit

(2) Formula used: $T_c = T_j - (P_d + P_{d_{REV}}) \times R_{thJC}$;

P_d = Forward Power Loss = $I_{F(AV)} \times V_{FM} @ (I_{F(AV)} / D)$ (see Fig. 6);

$P_{d_{REV}}$ = Inverse Power Loss = $V_{R1} \times I_R (1 - D)$; $I_R @ V_{R1} = 10V$

Outline Table

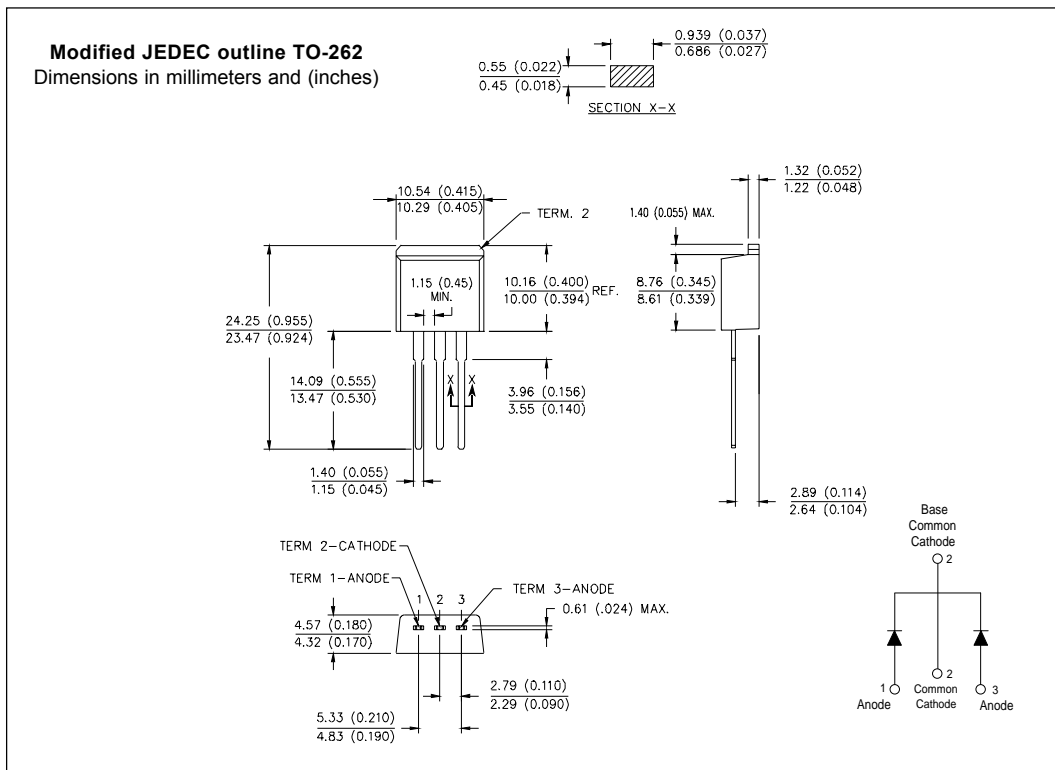
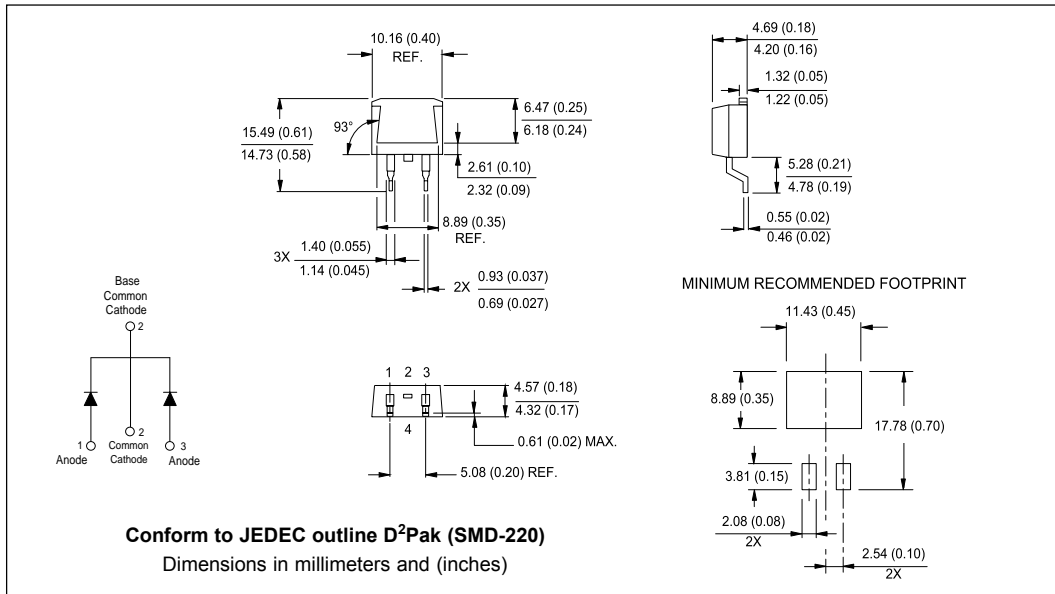

Part Marking Information

D²PAK

EXAMPLE: THIS IS A 10CTQ150S
LOT CODE 8024
ASSEMBLED ON WW 02, 2000

Note: "P" in assembly line position indicates "Lead-Free"

INTERNATIONAL RECTIFIER LOGO
PART NUMBER
DATE CODE
YEAR 0 = 2000
WEEK 02
P = LEAD-FREE

TO-262

EXAMPLE: THIS IS A 10CTQ150-1
LOT CODE 1789
ASSEMBLED ON WW 19, 2002

Note: "P" in assembly line position indicates "Lead-Free"

INTERNATIONAL RECTIFIER LOGO
PART NUMBER
DATE CODE
YEAR 2 = 2002
WEEK 19
P = LEAD-FREE

Tape & Reel Information

TRR
FEED DIRECTION

TRL
FEED DIRECTION

Dimensions in millimeters and (inches):

- 1.60 (0.063)
- 1.50 (0.059)
- 1.60 (0.063) DIA.
- 1.50 (0.059) DIA.
- 4.10 (0.161)
- 3.90 (0.153)
- 1.85 (0.073)
- 1.65 (0.065)
- 11.60 (0.457)
- 11.40 (0.449)
- 1.75 (0.069) DIA.
- 1.25 (0.049) DIA.
- 10.90 (0.429)
- 10.70 (0.421)
- 16.10 (0.634)
- 15.90 (0.626)
- 0.368 (0.0145)
- 0.342 (0.0135)
- 15.42 (0.609)
- 15.22 (0.601)
- 24.30 (0.957)
- 23.90 (0.941)
- 4.72 (0.186)
- 4.52 (0.178)
- 13.50 (0.532) DIA.
- 12.80 (0.504) DIA.
- 360 (14.173) DIA. MAX.
- 26.40 (1.039)
- 24.40 (0.961)
- 60 (2.362) DIA. MIN.

SMD-220 Tape & Reel
When ordering, indicate the part number, part orientation, and the quantity. Quantities are in multiples of 800 pieces per reel for both TRL and TRR.

Dimensions in millimeters and (inches)

Ordering Information Table

Device Code																	
	<table border="1" style="margin: auto;"> <tr> <td style="padding: 5px;">10</td> <td style="padding: 5px;">C</td> <td style="padding: 5px;">T</td> <td style="padding: 5px;">Q</td> <td style="padding: 5px;">150</td> <td style="padding: 5px;">S</td> <td style="padding: 5px;">TRL</td> <td style="padding: 5px;">PbF</td> </tr> <tr> <td style="text-align: center;">①</td> <td style="text-align: center;">②</td> <td style="text-align: center;">③</td> <td style="text-align: center;">④</td> <td style="text-align: center;">⑤</td> <td style="text-align: center;">⑥</td> <td style="text-align: center;">⑦</td> <td style="text-align: center;">⑧</td> </tr> </table>	10	C	T	Q	150	S	TRL	PbF	①	②	③	④	⑤	⑥	⑦	⑧
10	C	T	Q	150	S	TRL	PbF										
①	②	③	④	⑤	⑥	⑦	⑧										
1	- Current Rating (10A)																
2	- Circuit Configuration C = Common Cathode																
3	- T = TO-220																
4	- Schottky "Q" Series																
5	- Voltage Rating (150 = 150V)																
6	- <ul style="list-style-type: none"> • S = D²Pak • -1= TO-262 																
7	- <ul style="list-style-type: none"> • none = Tube (50 pieces) • TRL = Tape & Reel (Left Oriented - for D²Pak only) • TRR = Tape & Reel (Right Oriented - for D²Pak only) 																
8	- <ul style="list-style-type: none"> • none = Standard Production • PbF = Lead-Free 																

Data and specifications subject to change without notice.
 This product has been designed and qualified for Industrial Level and Lead-Free.
 Qualification Standards can be found on IR's Web site.