

Description

These devices are n-channel, enhancement mode, power MOSFETs designed especially for high speed applications, such as switching power supplies, converters, AC and DC motor controls, relay and solenoid drivers and other pulse circuits.

- Low RDS(on)
- VGS Rated at ±20V
- Silicon Gate for Fast Switching Speeds
- IDSS, VDS(on), Specified at Elevated Temperature
- Rugged
- Low Drive Requirements
- Ease of Paralleling

TO-204AA

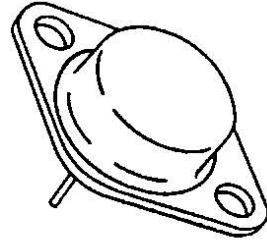

IS00020F

IRF120
 IRF121
 IRF122
 IRF123

TO-220AB

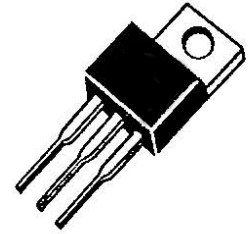

IS00010F

IRF520
 IRF521
 IRF522
 IRF523
 MTP10N08
 MTP10N10

Product Summary

Part Number	V _{DSS}	R _{DS(on)}	I _D at T _c =25	ID at TC=100	Case Style
IRF120	100V	0.30 Ω	8.0A	5.0A	TO-204AA
IRF121	60V	0.30 Ω	8.0A	5.0A	
IRF122	100V	0.40 Ω	7.0A	4.0A	
IRF123	60V	0.40 Ω	7.0A	4.0A	
IRF520	100V	0.30 Ω	8.0A	5.0A	TO-220AB
IRF521	60V	0.30 Ω	8.0A	5.0A	
IRF522	100V	0.40 Ω	7.0A	4.0A	
IRF523	60V	0.40 Ω	7.0A	4.0A	
MTP10N08	80V	0.30 Ω	10A	6.4A	
MTP10N10	100V	0.30 Ω	10A	6.4A	

Notes

For information concerning connection diagram and package outline, refer to Section 7.



IRF120-123/IRF520-523
MTP10N08/10N10
N-Channel Power Mosfets,
11A,60-100V

Maximum Rating

Symbol	Characteristic	Rating IRF120/122 IRF520/522 MTP10N10	Rating MTP10N08	Rating IRF122/123 IRF522/523	Unit
V _{DSS}	Drain to Source Voltage ¹	100	80	60	V
V _{DGR}	Drain to Gate Voltage ¹ R _{GS} =20kΩ	100	80	60	V
V _{GS}	Gate to Source Voltage	±20	±20	±20	V
T _J ,T _{stg}	Operating Junction and Storage Temperature	-55 to +150	-55 to +150	-55 to +150	
TL	Maximum Lead Temperature for Soldering Purposes, 1/8" From Case for 5s	275	275	275	

Maximum Thermal Characteristics

		IRF120-123/IRF520-523	MTP10N08/10	
R _{θJC}	Thermal Resistance Junction to Case	3.12	1.67	/W
R _{θJA}	Thermal Resistance, Junction to Ambient	30/80	80	/W
P _D	Total Power Dissipation at T _c =25	40	75	W
I _{DM}	Pulsed Drain Current ²	20	32	A

Electrical Characteristics (T_c=25 unless otherwise noted)

Symbol	Characteristic	Min	Max	Unit	Test Conditions
Off Characteristics					
V _{(BR)DSS}	Drain Source Breakdown Voltage ¹	100		V	V _{GS} =0V, I _D =250μA
	IRF120/122/520/522/ MTP10N10				
	MTP10N08 IRF121/123/521/523	80 60			
I _{DSS}	Zero Gate Voltage Drain Current		250	μA	V _{DS} =Rated V _{DSS} , V _{GS} =0V
			1000	μA	V _{DS} =0.8x Rated V _{DSS} , V _{GS} =0V, T _c =125
I _{GSS}	Gate-Body Leakage Current		±100 ±500	nA	V _{GS} =±20V, V _{DS} =0V
	IRF120-123				
	IRF520-523/MTP10N08/10				



IRF120-123/IRF520-523
MTP10N08/10N10
N-Channel Power Mosfets,
11A,60-100V

Electrical Characteristics (Cont.) (Tc=25 unless otherwise noted)

Symbol	Characteristic	Min	Max	Unit	Test Conditions
On Characteristics					
V _{GS(th)}	Gate Threshold Voltage IRF12-123/IRF520-523 MTP10N08/10N10	2.0	4.0	V	I _D =250μA, V _{DS} =V _{GS} I _D =1mA, V _{DS} =V _{GS}
		2.0	4.5		
R _{DS(on)}	Static Drain-Source On-Resistance ² IRF120/121/520/521 MTP10N08/10N10 IRF122/123/522/523		0.30	Ω	V _{GS} =10V I _D =4.0A I _D =5.0A I _D =4.0A
			0.33		
			0.40		
V _{DS(on)}	Drain-Source On-Voltage ² MTP 10N08/10N10		4.0	V	V _{GS} =10V; I _D =10.0A
			3.3	V	V _{GS} =10V, I _D =5.0A Tc=100
g _{fs}	Forward Transconductance	1.5		S(Ω)	V _{DS} =10V, I _D =4.0A
Dynamic Characteristics					
C _{iss}	Input Capacitance		600	pF	V _{DS} =25V, V _{GS} =0V f=1.0MHz
C _{oss}	Output Capacitance		400	pF	
C _{rss}	Reverse Transfer Capacitance		100	pF	
Switching Characteristics (Tc=25, Figure 1,2) ³					
t _{d(on)}	Turn-On Delay Time		40	ns	V _{DD} =50V, I _D =4.0A V _{GS} =10V, R _{GEN} =50 Ω R _{GS} =50 Ω
t _r	Rise Time		70	ns	
t _{d(off)}	Turn-Off Delay Time		100	ns	
t _f	Fall Time		70	ns	
Q _g	Total Gate Charge		15	nC	V _{GS} =10V, I _D =10A V _{DD} =50V
Symbol Characteristic Typ Max Unit Test Conditions					
Source-Drain Diode Characteristics					
V _{SD}	Diode Forward Voltage IRF120/121/520/521 IRF122/123/522/523		2.5	V	I _S =8.0A; V _{GS} =0V
			2.3	V	I _S =7.0A; V _{GS} =0V
t _{rr}	Reverse Recovery Time	280		ns	I _S =4.0A; dI _S /dt=25A/

Notes

1. T_J=+25 to +150
2. Pulse width limited by T_J
3. Switching time measurements performed on LEM TR-58 test equipment.

Typical Electrical Characteristics
Figure 1 Switching Test Circuit

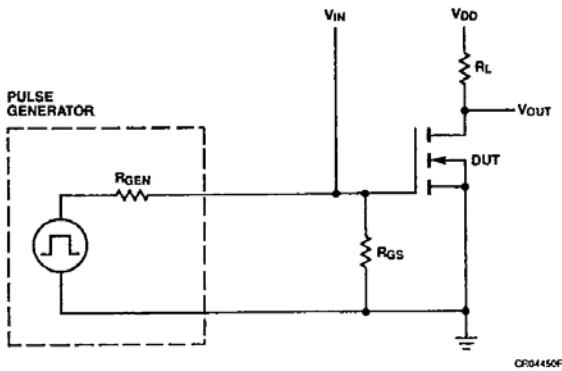

CP04450F

Figure 2 Switching Waveforms

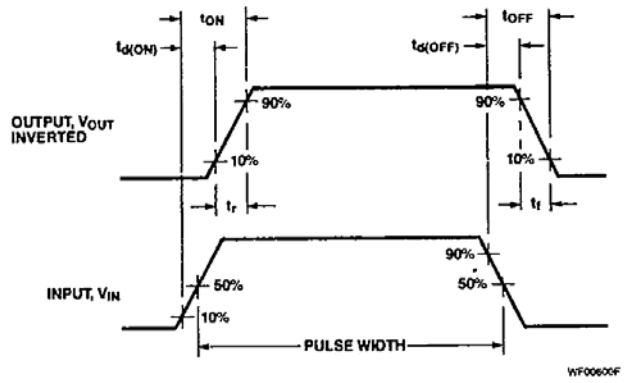

WF00600F

Typical Performance Curves
Figure 3 Output Characteristics

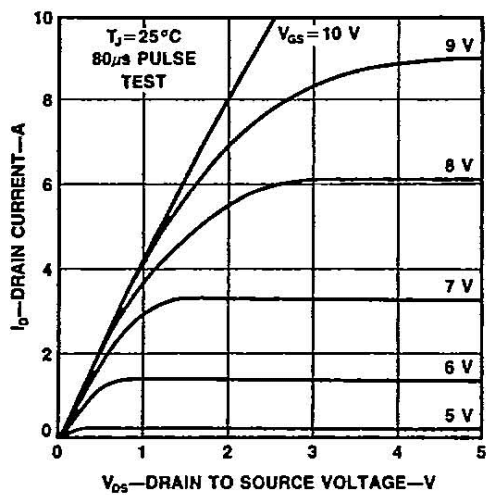

PC09660F

Figure 4 Static Drain to Source Resistance
VS Drain Current

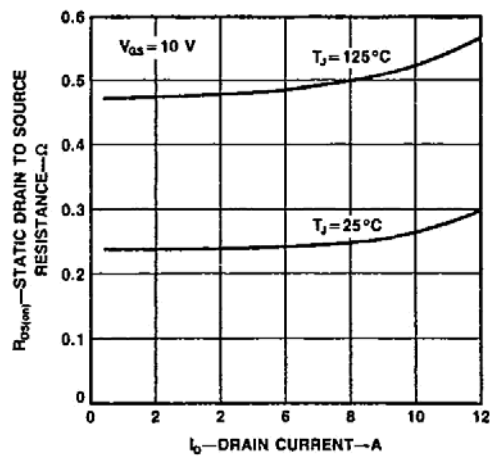

PC09670F

Figure 6 Temperature Variation of Gate to Source Threshold Voltage

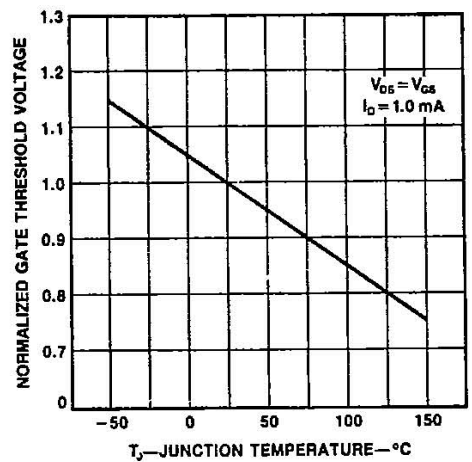

PC09641F

Figure 5 Transfer Characteristics

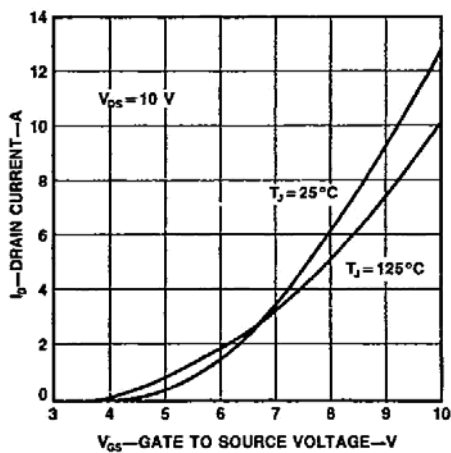

PC09680F

Typical Performance Curves (Cont.)

Figure 7 Capacitance vs Drain to Source Voltage

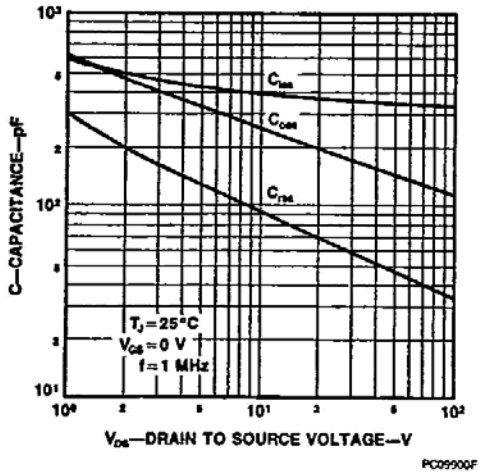

Figure 9 Forward Biased Safe Operating Area For IRF12-123 And IRF520-523

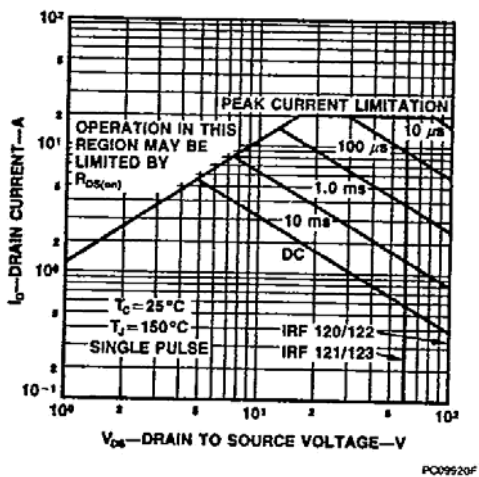

Figure 11 Forward Biased Safe Operating Area For MTP10N08/10N10

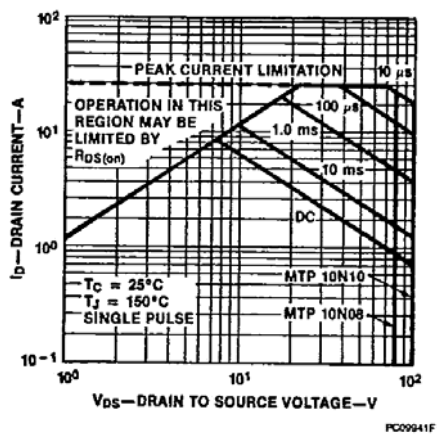

Figure 8 Gate to Source Voltage vs Total Gate Charge

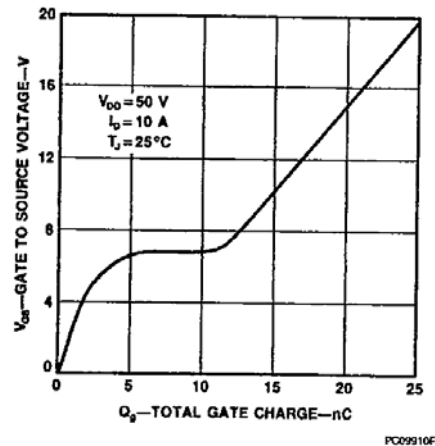

Figure 10 Transient Thermal Resistance vs Time for IRF120-123 And IRF520-523

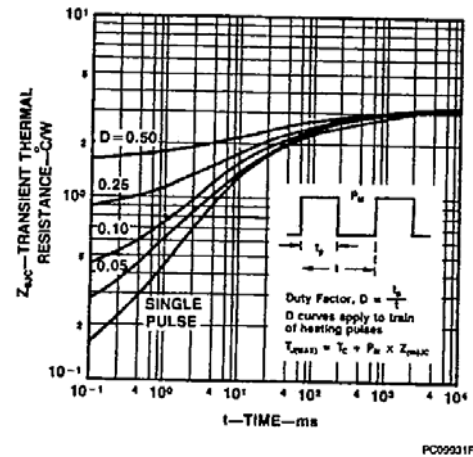

Figure 12 Transient Thermal Resistance vs time for MTP10N08/10N10

