

## ESD Protection Arrays, Chip Scale Package

### Features

- Functionally and pin compatible with CMD's PACDN2404C/08C/16C family of devices
- OptiGuard™ coated for improved reliability at assembly
- 4, 8, or 16 transient voltage suppressors in a single package
- In-system Electrostatic Discharge (ESD) protection to  $\pm 18\text{kV}$  contact discharge per IEC 61000-4-2 international standard
- Supports AC signal applications
- Compact Chip Scale Package (0.65mm pitch) format saves board space and eases layout in space critical applications compared to discrete solutions and traditional wire bonded packages
- Lead-free versions available

### Applications

- ESD protection for sensitive electronic equipment
- I/O port, keypad and button circuitry protection for portable devices
- Wireless Handsets
- Handheld PCs / PDAs
- MP3 Players
- Digital Cameras and Camcorders
- Notebooks
- Desktop PCs

### Product Description

The CM1206 family of transient voltage suppressor arrays provides a very high level of protection for sensitive electronic components that may be subjected to ESD. The back-to-back Zener connections provide ESD protection in cases where nodes with AC signals are present.

These devices are designed and characterized to safely dissipate ESD strikes at levels well beyond the maximum requirements set forth in the IEC 61000-4-2 international standard. All I/Os are rated at  $\pm 18\text{kV}$  using the IEC 61000-4-2 contact discharge method. Using the MIL-STD-883D (Method 3015) specification for Human Body Model (HBM) ESD, all pins are protected for contact discharges to greater than  $\pm 30\text{kV}$ .

The Chip Scale Package format of these devices enable extremely small footprints that are necessary in portable electronics such as cellular phones, PDAs, internet appliances and PCs. The large solder bumps allow for standard attachment to laminate boards without the use of underfill.

The CM1206 incorporates OptiGuard™ coating which results in improved reliability at assembly. The CM1206 is also available with optional lead-free finishing.

### Electrical Schematic

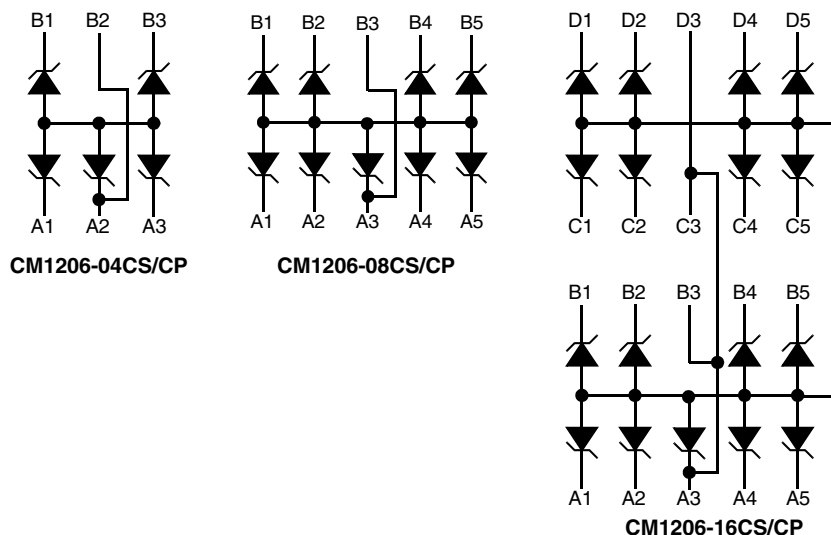

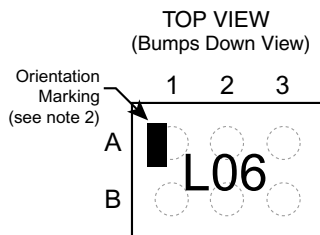
**PACKAGE / PINOUT DIAGRAMS**

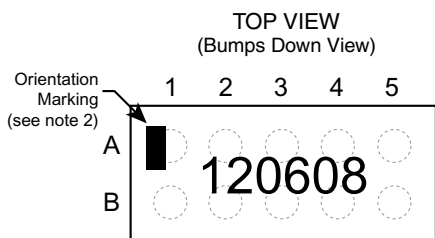
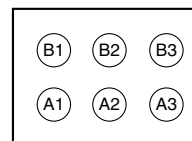
 CM1206-04  
CSP Package

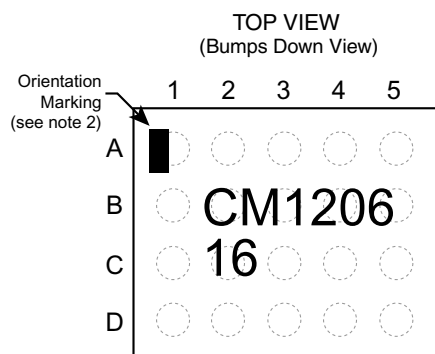
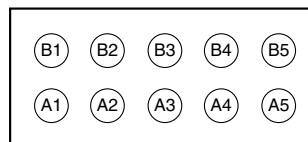
 BOTTOM VIEW  
(Bumps Up View)

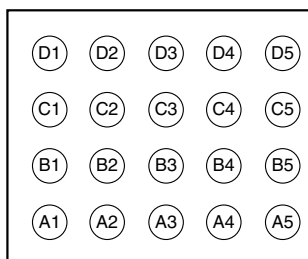
 CM1206-08  
CSP Package

 BOTTOM VIEW  
(Bumps Up View)

 CM1206-16  
CSP Package

 BOTTOM VIEW  
(Bumps Up View)

**Notes:**

- 1) These drawings are not to scale.
- 2) Lead-free devices are specified by using a "+" character for the top side orientation mark.

**Ordering Information**
**PART NUMBERING INFORMATION**

Bumps	Package	Standard Finish		Lead-free Finish <sup>2</sup>	
		Ordering Part Number <sup>1</sup>	Part Marking	Ordering Part Number <sup>1</sup>	Part Marking
6	CSP	CM1206-04CS	L06	CM1206-04CP	L06
10	CSP	CM1206-08CS	120608	CM1206-08CP	120608
20	CSP	CM1206-16CS	CM120616	CM1206-16CP	CM120616

Note 1: Parts are shipped in Tape &amp; Reel form unless otherwise specified.

Note 2: Lead-free devices are specified by using a "+" character for the top side orientation mark

## Specifications

### ABSOLUTE MAXIMUM RATINGS

PARAMETER	RATING	UNITS
Storage Temperature Range	-65 to +150	°C

### STANDARD OPERATING CONDITIONS

PARAMETER	RATING	UNITS
Operating Temperature Range	-40 to +85	°C

### ELECTRICAL OPERATING CHARACTERISTICS (NOTE 1)

SYMBOL	PARAMETER	CONDITIONS	MIN	TYP	MAX	UNITS
$V_{REV}$	Reverse Standoff Voltage	$I_{DIODE}=10\mu A$	5.9			V
$I_{LEAK}$	Leakage Current	$V_{IN}=3.3V$ DC			100	nA
$V_{SIG}$	Signal Clamp Voltage Positive Clamp Negative Clamp	$I_{LOAD} = 10mA$	6.0 -9.2	7.6 -7.6	9.2 -6.0	V V
$V_{ESD}$	In-system ESD Withstand Voltage a) Human Body Model, MIL-STD-883, Method 3015 b) Contact Discharge per IEC 61000-4-2 Level 4	Notes 2 & 3	$\pm 30$ $\pm 18$			kV kV
$V_{CL}$	Clamping Voltage during ESD Discharge MIL-STD-883 (Method 3015), 8kV Positive Transients Negative Transients	Notes 2 & 3		+14 -14		V V
C	Channel Capacitance	At 2.5V DC, $f = 1MHz$		39	47	pF

Note 1:  $T_A=25^\circ C$  unless otherwise specified. GND in this document refers to the lower supply voltage.

Note 2: ESD applied to channel pins with respect to GND, one at a time. All other channels are open. All GND pins tied to ground.

Note 3: These parameters are guaranteed by design and characterization.

## Application Information

Refer to Application Note AP-217, "The Chip Scale Package", for a detailed description of Chip Scale Packages offered by California Micro Devices.

### PRINTED CIRCUIT BOARD RECOMMENDATIONS

PARAMETER	VALUE
Pad Size on PCB	0.300mm
Pad Shape	Round
Pad Definition	Non-Solder Mask defined pads
Solder Mask Opening	0.350mm Round
Solder Stencil Thickness	0.125 - 0.150mm
Solder Stencil Aperture Opening (laser cut, 5% tapered walls)	0.360mm Round
Solder Flux Ratio	50/50 by volume
Solder Paste Type	No Clean
Pad Protective Finish	OSP (Entek Cu Plus 106A)
Tolerance — Edge To Corner Ball	$\pm 50\mu\text{m}$
Solder Ball Side Coplanarity	$\pm 20\mu\text{m}$
Maximum Dwell Time Above Liquidous	60 seconds
Soldering Maximum Temperature	260°C

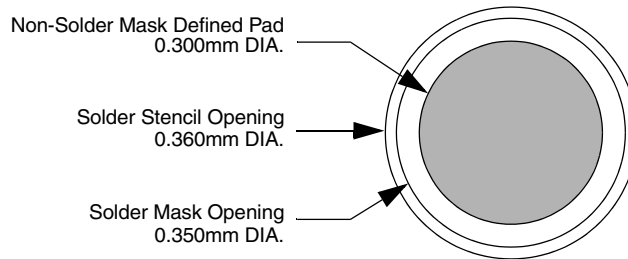

Figure 1. Recommended Non-Solder Mask Defined Pad Illustration

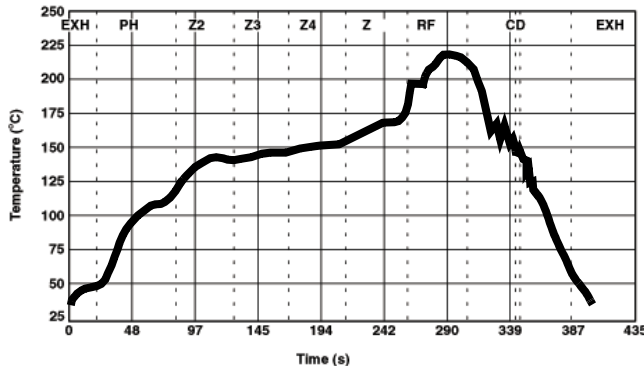

Figure 2. Eutectic (SnPb) Solder Ball Reflow Profile

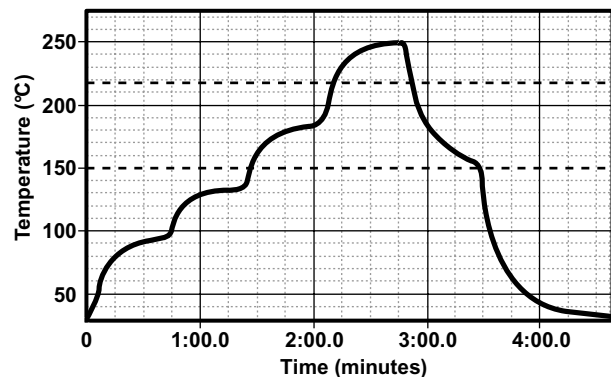

Figure 3. Lead-free (SnAgCu) Solder Ball Reflow Profile

### Mechanical Details

The CM1206 devices are packaged in custom Chip Scale Packages (CSP).

#### CM1206-04 6-bump CSP Mechanical Specifications

The CM1206-04 devices are packaged in a 6-bump custom Chip Scale Package (CSP). Dimensions are presented below.

PACKAGE DIMENSIONS						
Package	Custom CSP					
Bumps	6					
Dim	Millimeters			Inches		
	Min	Nom	Max	Min	Nom	Max
A1	1.109	1.154	1.199	0.0437	0.0454	0.0472
A2	1.759	1.804	1.849	0.0693	0.0710	0.0728
B1	0.645	0.650	0.655	0.0254	0.0256	0.0258
B2	0.645	0.650	0.655	0.0254	0.0256	0.0258
B3	0.645	0.650	0.655	0.0254	0.0256	0.0258
C1	0.202	0.252	0.302	0.0080	0.0099	0.0119
C2	0.202	0.252	0.302	0.0080	0.0099	0.0119
D1	0.638	0.707	0.776	0.0251	0.0278	0.0306
D2	0.394	0.445	0.495	0.0155	0.0175	0.0195
# per tape and reel	3500 pieces					
Controlling dimension: millimeters						

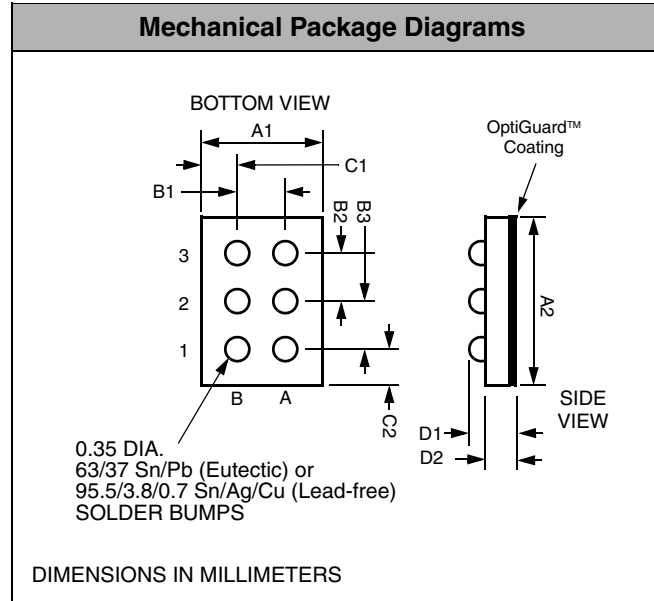

Package Dimensions for CM1206-04 6-bump Chip Scale Package

### CSP Tape and Reel Specifications

PART NUMBER	CHIP SIZE (mm)	POCKET SIZE (mm) B <sub>0</sub> X A <sub>0</sub> X K <sub>0</sub>	TAPE WIDTH W	REEL DIA.	QTY PER REEL	P <sub>0</sub>	P <sub>1</sub>
CM1206-04	1.804 X 1.154 X 0.707	1.98 X 1.32 X 0.91	8mm	178mm (7")	3500	4mm	4mm

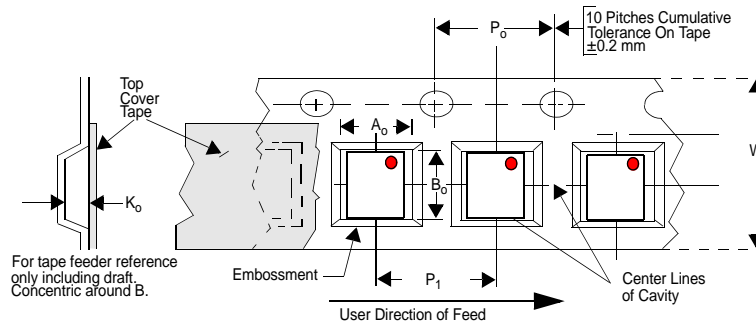

Figure 4. Tape and Reel Mechanical Data

**Mechanical Details (cont'd)**

**CM1206-08 10-bump CSP Mechanical Specifications**

The CM1206-08 devices are packaged in a 6-bump custom Chip Scale Package (CSP). Dimensions are presented below.

PACKAGE DIMENSIONS						
Package	Custom CSP					
Bumps	10					
Dim	Millimeters			Inches		
	Min	Nom	Max	Min	Nom	Max
A1	1.109	1.154	1.199	0.0437	0.0454	0.0472
A2	3.059	3.104	3.149	0.1204	0.1222	0.1240
B1	0.645	0.650	0.655	0.0254	0.0256	0.0258
B2	0.645	0.650	0.655	0.0254	0.0256	0.0258
C1	0.202	0.252	0.302	0.0080	0.0099	0.0119
C2	0.202	0.252	0.302	0.0080	0.0099	0.0119
D1	0.638	0.707	0.776	0.0251	0.0278	0.0306
D2	0.394	0.445	0.495	0.0155	0.0175	0.0195
# per tape and reel	3500 pieces					
Controlling dimension: millimeters						

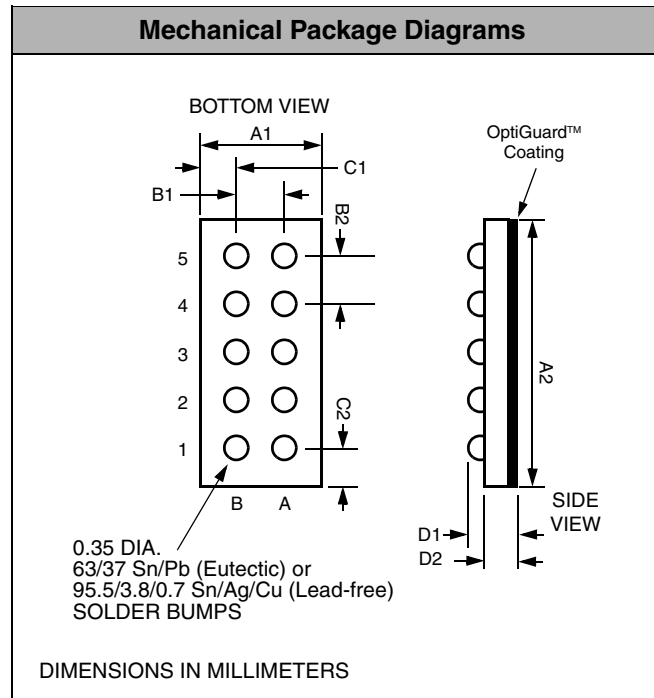

**Package Dimensions for  
CM1206-08 10-bump Chip Scale Package**

**CSP Tape and Reel Specifications**

PART NUMBER	CHIP SIZE (mm)	POCKET SIZE (mm) B <sub>0</sub> X A <sub>0</sub> X K <sub>0</sub>	TAPE WIDTH W	REEL DIAMETER	QTY PER REEL	P <sub>0</sub>	P <sub>1</sub>
CM1206-08	3.104 X 1.154 X 0.707	3.28 X 1.32 X 0.81	8mm	178mm (7")	3500	4mm	4mm

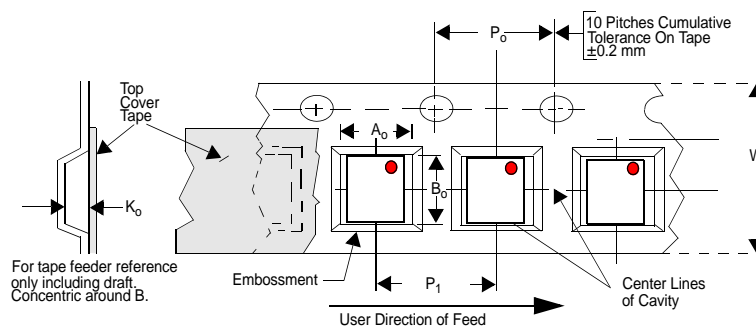

**Figure 5. Tape and Reel Mechanical Data**

## Mechanical Details (cont'd)

### CM1206-16 20-bump CSP Mechanical Specifications

The CM1206-16 devices are packaged in a 20-bump custom Chip Scale Package (CSP). Dimensions are presented below.

PACKAGE DIMENSIONS						
Package	Custom CSP					
Bumps	20					
Dim	Millimeters			Inches		
	Min	Nom	Max	Min	Nom	Max
A1	2.409	2.454	2.499	0.0948	0.0966	0.0984
A2	3.059	3.104	3.149	0.1204	0.1222	0.1240
B1	0.645	0.650	0.655	0.0254	0.0256	0.0258
B2	0.645	0.650	0.655	0.0254	0.0256	0.0258
C1	0.202	0.252	0.302	0.0080	0.0099	0.0119
C2	0.202	0.252	0.302	0.0080	0.0099	0.0119
D1	0.638	0.707	0.776	0.0251	0.0278	0.0306
D2	0.394	0.445	0.495	0.0155	0.0175	0.0195
# per tape and reel	3500 pieces					
Controlling dimension: millimeters						

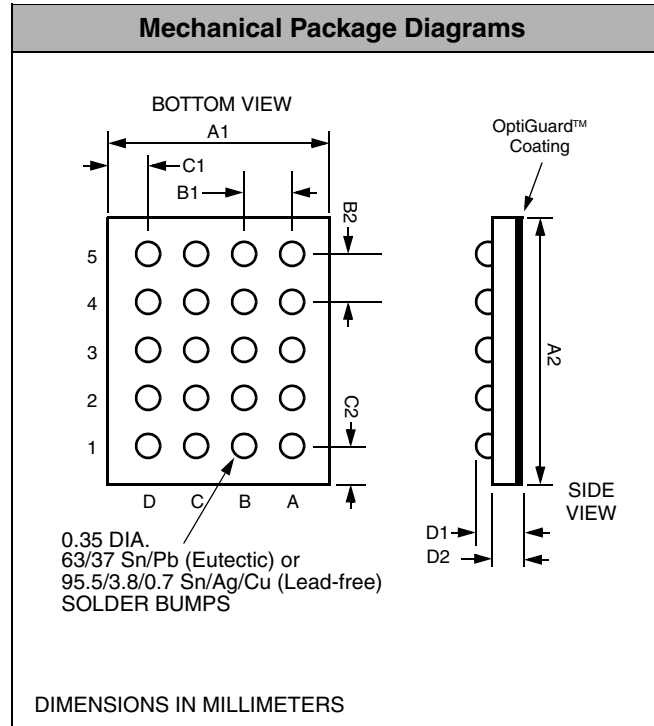

**Package Dimensions for  
CM1206-16 20-bump Chip Scale Package**

### CSP Tape and Reel Specifications

PART NUMBER	CHIP SIZE (mm)	POCKET SIZE (mm) $B_0 \times A_0 \times K_0$	TAPE WIDTH W	REEL DIAMETER	QTY PER REEL	$P_0$	$P_1$
CM1206-16	3.104 X 2.454 X 0.707	3.28 X 2.64 X 0.86	8mm	178mm (7")	3500	4mm	4mm

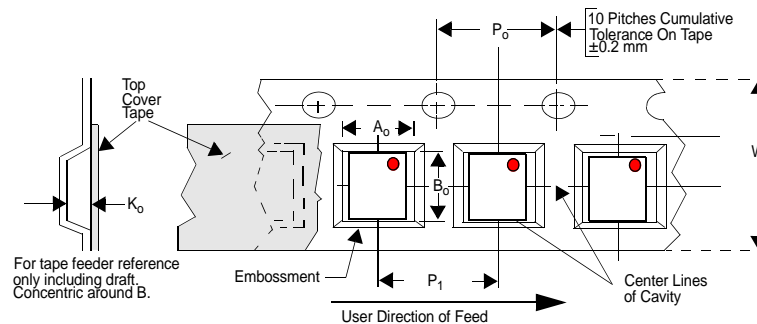

**Figure 6. Tape and Reel Mechanical Data**