

International IOR Rectifier

SCHOTTKY RECTIFIER

12CTQ... 12CTQ...S 12CTQ...-1

12 Amp

$$I_{F(AV)} = 12\text{Amp}$$

$$V_R = 35/45\text{V}$$

Major Ratings and Characteristics



Characteristics	12CTQ	Units
$I_{F(AV)}$ Rectangular waveform	12	A
V_{RRM} range	35/45	V
I_{FSM} @ tp = 5 μ s sine	690	A
V_F @ 6 Apk, $T_J = 125^\circ\text{C}$ (per leg)	0.53	V
T_J range	-55 to 175	$^\circ\text{C}$

Description/ Features

The 12CTQ center tap Schottky rectifier series has been optimized for low reverse leakage at high temperature. The proprietary barrier technology allows for reliable operation up to 175° C junction temperature. Typical applications are in switching power supplies, converters, free-wheeling diodes, and reverse battery protection.

- 175° C T_J operation
- Center tap TO-220 package
- Low forward voltage drop
- High purity, high temperature epoxy encapsulation for enhanced mechanical strength and moisture resistance
- High frequency operation
- Guard ring for enhanced ruggedness and long term reliability

Case Styles

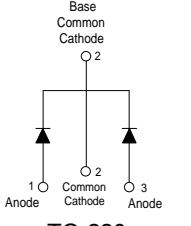
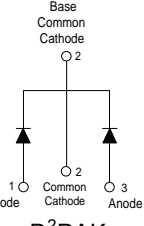
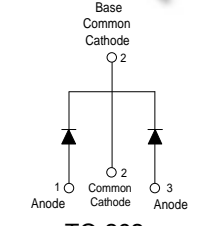
12CTQ...	12CTQ...S	12CTQ...-1
		
<p>Base Common Cathode</p> <p>2</p>  <p>1 Anode 2 Common Cathode 3 Anode</p> <p>TO-220</p>	<p>Base Common Cathode</p> <p>2</p>  <p>1 Anode 2 Common Cathode 3 Anode</p> <p>D²PAK</p>	<p>Base Common Cathode</p> <p>2</p>  <p>1 Anode 2 Common Cathode 3 Anode</p> <p>TO-262</p>

12CTQ... Series

Bulletin PD-20554 rev. C 07/06

International
IR Rectifier

Voltage Ratings

Part number	12CTQ035	12CTQ040	12CTQ045
V_R Max. DC Reverse Voltage (V)	35	40	45
V_{RWM} Max. Working Peak Reverse Voltage (V)			

Absolute Maximum Ratings

Parameters	12CTQ	Units	Conditions
$I_{F(AV)}$ Max. Average Forward (Per Leg) Current * See Fig. 5 (Per Device)	6	A	50% duty cycle @ $T_C = 160^\circ\text{C}$, rectangular wave form
	12		
I_{FSM} Max. Peak One Cycle Non-Repetitive Surge Current (Per Leg) * See Fig. 7	690	A	5 μs Sine or 3 μs Rect. pulse
	140		10ms Sine or 6ms Rect. pulse
E_{AS} Non-Repetitive Avalanche Energy (Per Leg)	8	mJ	$T_J = 25^\circ\text{C}$, $I_{AS} = 1.20$ Amps, $L = 11.10$ mH
I_{AR} Repetitive Avalanche Current (Per Leg)	1.20	A	Current decaying linearly to zero in 1 μsec Frequency limited by T_J max. $V_A = 1.5 \times V_R$ typical

Electrical Specifications

Parameters	12CTQ	Units	Conditions
V_{FM} Max. Forward Voltage Drop (Per Leg) * See Fig. 1 (1)	0.60	V	@ 6A
	0.73	V	@ 12A
	0.53	V	@ 6A
	0.64	V	@ 12A
I_{RM} Max. Reverse Leakage Current (Per Leg) * See Fig. 2 (1)	0.8	mA	$T_J = 25^\circ\text{C}$
	7.0	mA	$T_J = 125^\circ\text{C}$
$V_{F(TO)}$ Threshold Voltage	0.35	V	$T_J = T_J$ max.
r_t Forward Slope Resistance	18.23	m Ω	
C_T Max. Junction Capacitance (Per Leg)	400	pF	$V_R = 5V_{DC}$ (test signal range 100Khz to 1Mhz) 25°C
L_S Typical Series Inductance (Per Leg)	8.0	nH	Measured lead to lead 5mm from package body
dv/dt Max. Voltage Rate of Change	10000	V/ μs	(Rated V_R)

(1) Pulse Width < 300 μs , Duty Cycle <2%

Thermal-Mechanical Specifications

Parameters	12CTQ	Units	Conditions
T_J Max. Junction Temperature Range	-55 to 175	$^\circ\text{C}$	
T_{stg} Max. Storage Temperature Range	-55 to 175	$^\circ\text{C}$	
R_{thJC} Max. Thermal Resistance Junction to Case (Per Leg)	3.50	$^\circ\text{C/W}$	DC operation * See Fig. 4
R_{thJC} Max. Thermal Resistance Junction to Case (Per Package)	1.75	$^\circ\text{C/W}$	DC operation
R_{thCS} Typical Thermal Resistance, Case to Heatsink	0.50	$^\circ\text{C/W}$	Mounting surface, smooth and greased
wt Approximate Weight	2 (0.07)	g (oz.)	
T Mounting Torque	Min.	6 (5)	Kg-cm (lbf-in)
	Max.	12 (10)	

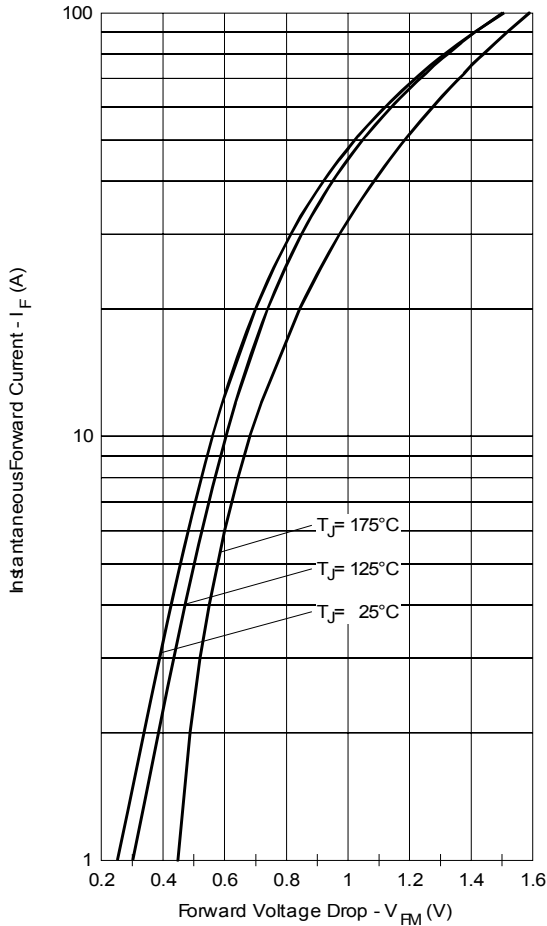

Fig. 1 - Max. Forward Voltage Drop Characteristics (Per Leg)

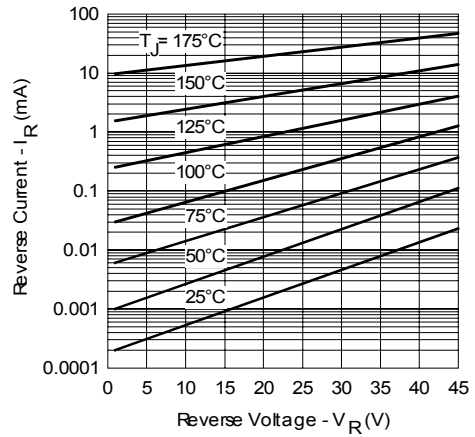

Fig. 2 - Typical Values Of Reverse Current Vs. Reverse Voltage (Per Leg)

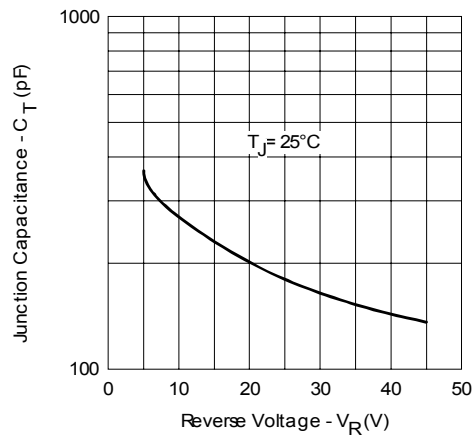

Fig. 3 - Typical Junction Capacitance Vs. Reverse Voltage (Per Leg)

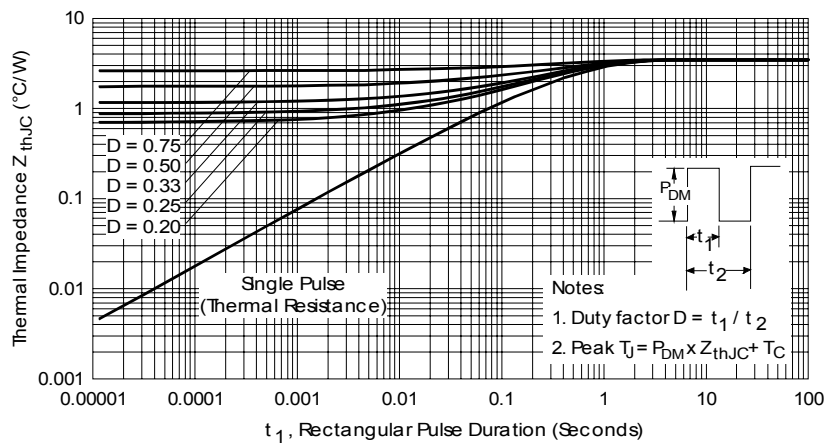

Fig. 4 - Max. Thermal Impedance Z_{thJC} Characteristics (Per Leg)

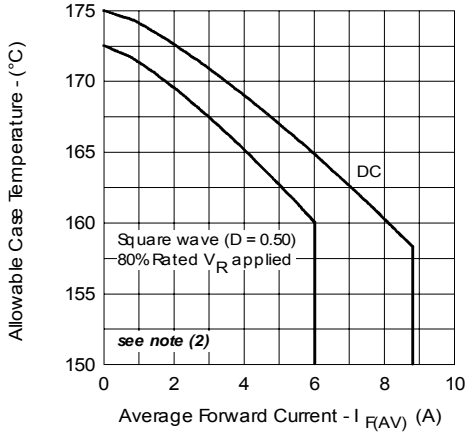

Fig. 5 - Max. Allowable Case Temperature Vs. Average Forward Current (Per Leg)

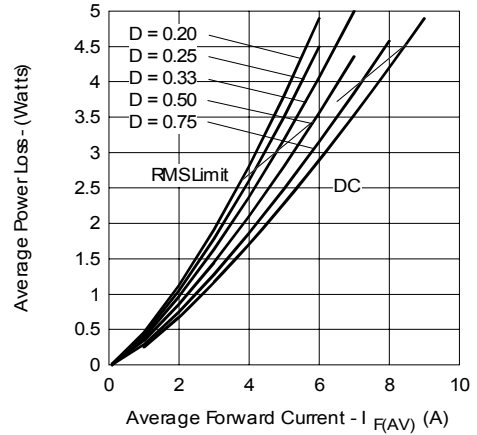

Fig. 6 - Forward Power Loss Characteristics (Per Leg)

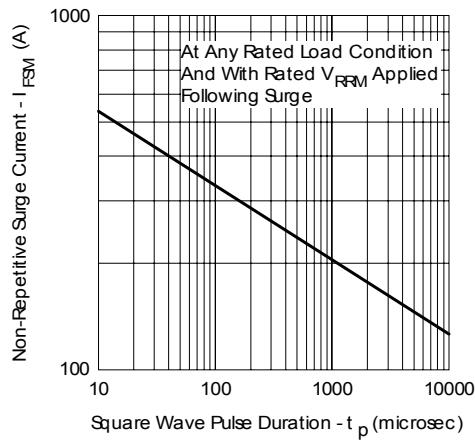

Fig. 7 - Max. Non-Repetitive Surge Current (Per Leg)

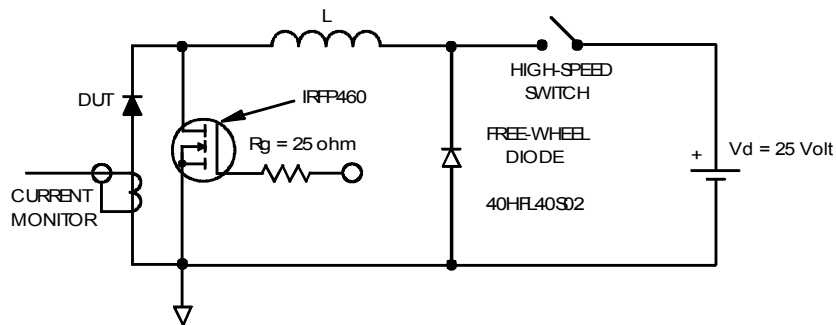
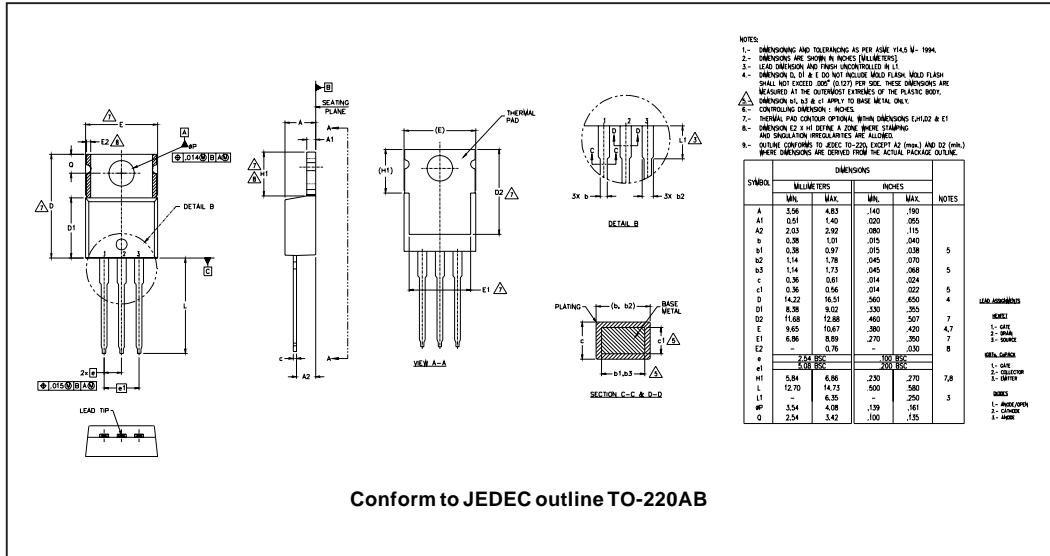

Fig. 8 - Unclamped Inductive Test Circuit

- (2) Formula used: $T_c = T_j - (Pd + Pd_{REV}) \times R_{thJC}$;
 $Pd = \text{Forward Power Loss} = I_{F(AV)} \times V_{FM} @ (I_{F(AV)} / D)$ (see Fig. 6);
 $Pd_{REV} = \text{Inverse Power Loss} = V_{R1} \times I_R (1 - D)$; $I_R @ V_{R1} = 80\%$ rated V_R

Outline Table



Conform to JEDEC outline TO-220AB

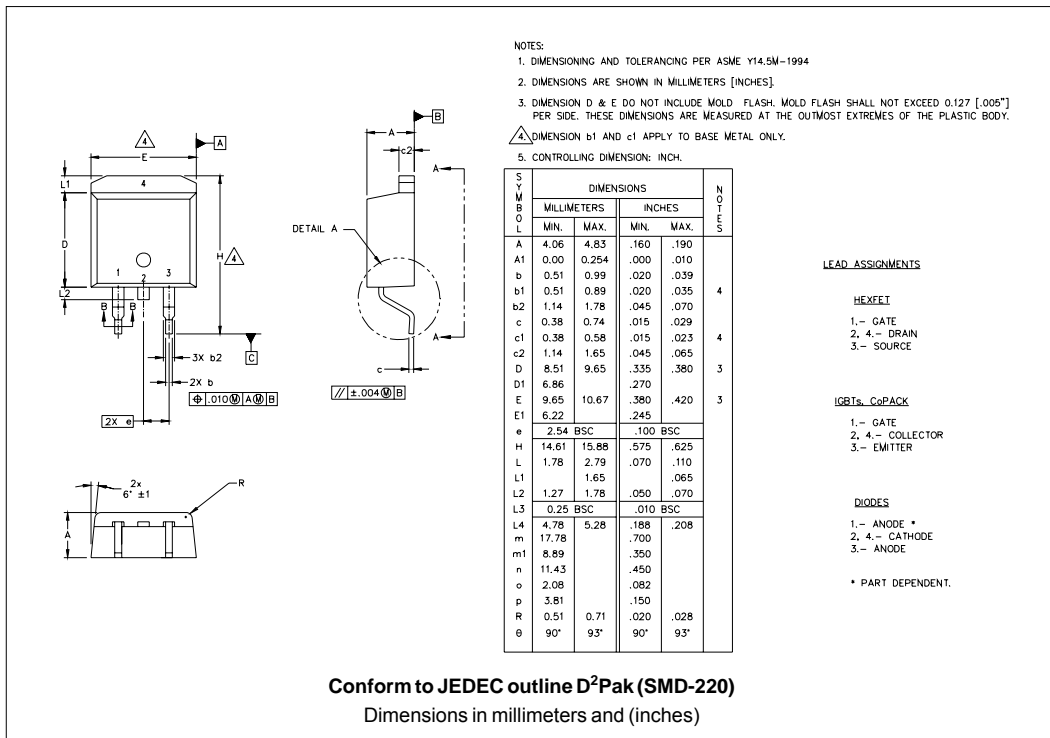

Conform to JEDEC outline D²Pak (SMD-220)
 Dimensions in millimeters and (inches)

Outline Table

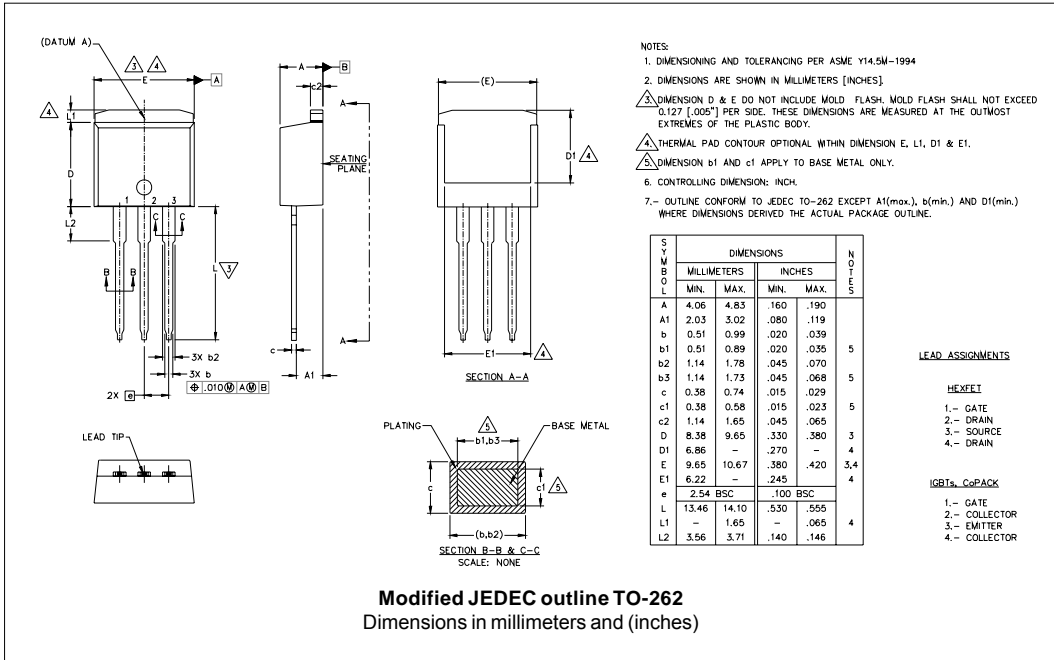

Tape & Reel Information

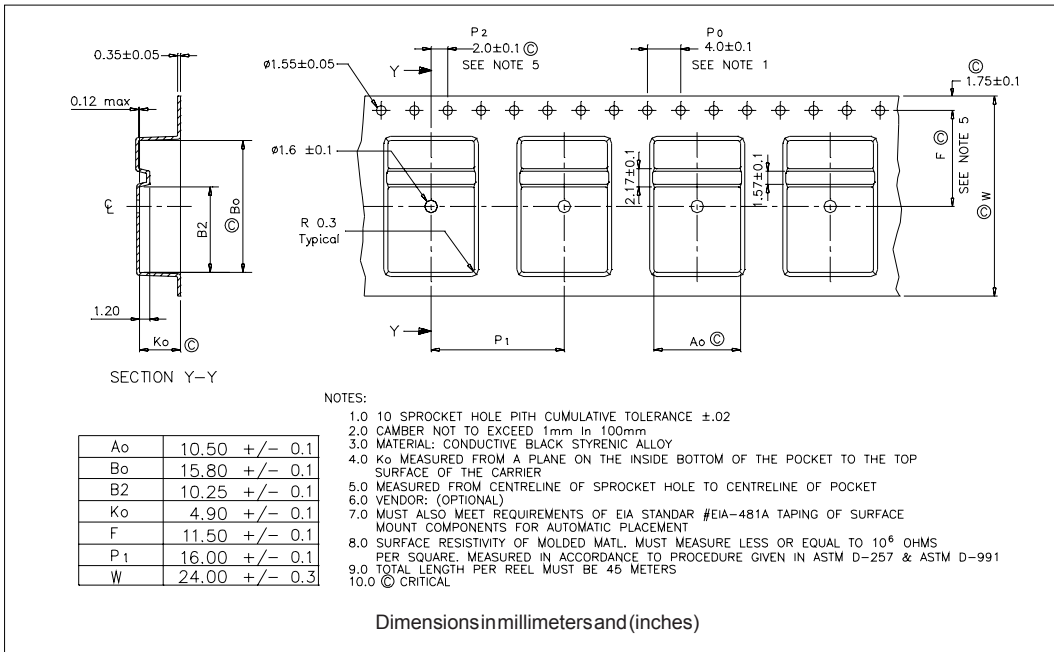

Part Marking Information

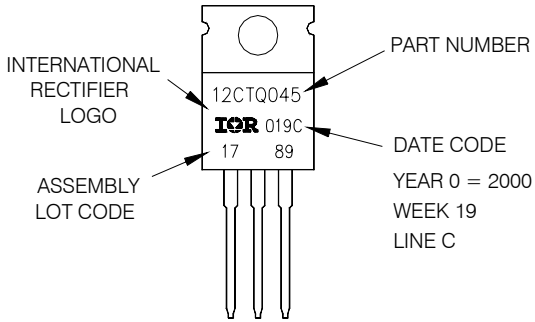
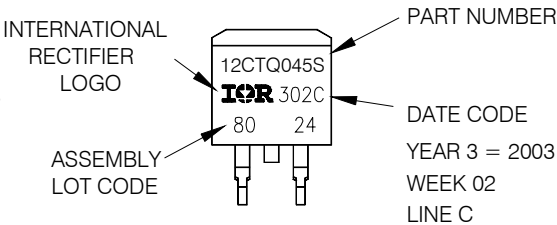
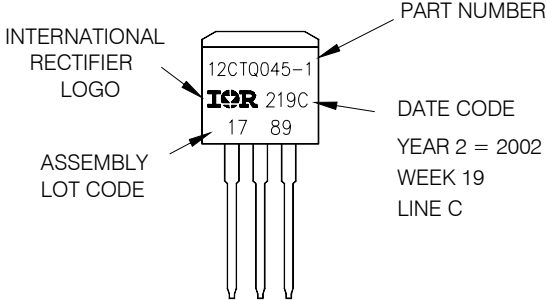
<p>TO-220</p> <p>EXAMPLE: THIS IS A 12CTQ045 LOT CODE 1789 ASSEMBLED ON WW 19, 2000 IN THE ASSEMBLY LINE "C"</p>	 <p>INTERNATIONAL RECTIFIER LOGO</p> <p>ASSEMBLY LOT CODE</p> <p>PART NUMBER</p> <p>DATE CODE</p> <p>YEAR 0 = 2000 WEEK 19 LINE C</p>
<p>D²PAK</p> <p>EXAMPLE: THIS IS A 12CTQ045S LOT CODE 8024 ASSEMBLED ON WW 02, 2003 IN ASSEMBLY LINE "C"</p>	 <p>INTERNATIONAL RECTIFIER LOGO</p> <p>ASSEMBLY LOT CODE</p> <p>PART NUMBER</p> <p>DATE CODE</p> <p>YEAR 3 = 2003 WEEK 02 LINE C</p>
<p>TO-262</p> <p>EXAMPLE: THIS IS A 12CTQ045-1 LOT CODE 1789 ASSEMBLED ON WW 19, 2002 IN ASSEMBLY LINE "C"</p>	 <p>INTERNATIONAL RECTIFIER LOGO</p> <p>ASSEMBLY LOT CODE</p> <p>PART NUMBER</p> <p>DATE CODE</p> <p>YEAR 2 = 2002 WEEK 19 LINE C</p>

Ordering Information Table

Device Code							
12	C	T	Q	045	S	TRL	-
①	②	③	④	⑤	⑥	⑦	⑧
1	-	Current Rating (12A)					
2	-	Circuit Configuration					
		C = Common Cathode					
3	-	T = TO-220					
4	-	Schottky "Q" Series					
5	-	Voltage Ratings					
6	-	• S = D ² Pak					
		• -1 = TO-262					
7	-	• none = Tube (50 pieces)					
		• TRL = Tape & Reel (Left Oriented - for D ² Pak only)					
		• TRR = Tape & Reel (Right Oriented - for D ² Pak only)					
8	-	• none = Standard Production					
		• PbF = Lead-Free					

035 = 35V
 040 = 40V
 045 = 45V

Data and specifications subject to change without notice.
 This product has been designed and qualified for Industrial Level.
 Qualification Standards can be found on IR's Web site.