



DATA SHEET

1N5334B~1N5378B

GLASS PASSIVATED JUNCTION SILICON ZENER DIODES

VOLTAGE 3.6 to 100 Volts **CURRENT** 5.0 Watts

DO-201AE Unit: inch(mm)

FEATURES

- For surface mounted applications in order to optimize board space.
- Low profile package
- Built-in strain relief
- Glass passivated junction
- Low inductance
- Typical I_p less than 1.0 μ A above 13V
- Plastic package has Underwriters Laboratory Flammability Classification 94V-0
- Pb free product are available : 99% Sn can meet RoHS environment substance directive request

MECHANICAL DATA

Case: JEDEC DO-201AE molded plastic
 Terminals: Axial leads, solderable per MIL-STD-750, Method 2026
 Polarity: Color band denoted cathode except Bipolar
 Mounting Position: Any
 Weight: 0.045 ounce, 1.2 gram

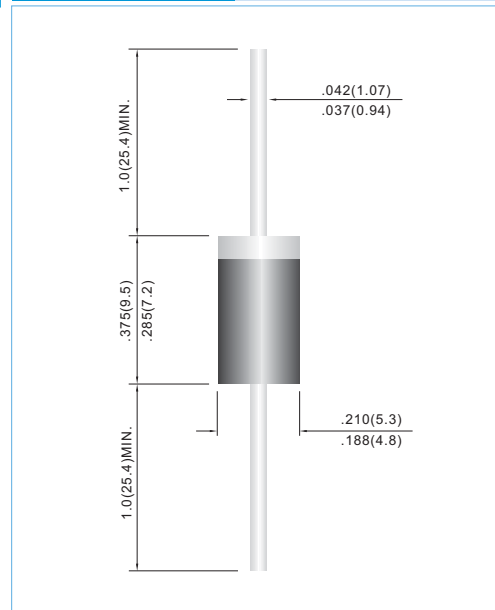

MAXIMUM RATINGS AND ELECTRICAL CHARACTERISTICS

Ratings at 25°C ambient temperature unless otherwise specified.

Parameter	Symbol	Value	Units
DC Power Dissipation on $T_L=75^\circ\text{C}$, Measure at Zero Lead Length Derate above 50°C (NOTE 1)	P_D	5.0 40	Watts mW / °C
Operating Junction and Storage Temperature Range	T_J, T_{STG}	-50 to +150	°C

NOTE:

1. Mounted on 8.0mm² copper pads to each terminal.



Part Number	Nominal Zener Voltage			Maximum Zener Impedance				Maximum Leakage Current	
	Vz @ IzT			ZzT @ IzT		Zzk @ Izk		IR	VR
	Nom. V	Min. V	Max. V	Ohms	mA	Ohms	mA	μA	V
1N5334B	3.6	3.4	3.8	2.5	350	500	1	150	1
1N5335B	3.9	3.7	4.1	2	320	500	1	50	1
1N5336B	4.3	4.1	4.52	2	290	500	1	10	1
1N5337B	4.7	4.5	4.9	2	260	450	1	5	1
1N5338B	5.1	4.9	5.4	1.5	240	400	1	1	1
1N5339B	5.6	5.3	5.9	1	220	400	1	1	2
1N5340B	6	5.7	6.3	1	200	300	1	1	3
1N5341B	6.2	5.9	6.5	1	200	200	1	1	3
1N5342B	6.8	6.5	7.1	1	175	200	1	10	5.2
1N5343B	7.5	7.1	7.9	1.5	175	200	1	10	5.7
1N5344B	8.2	7.8	8.6	1.5	150	200	1	10	6.2
1N5345B	8.7	8.3	9.1	2	150	200	1	10	6.6
1N5346B	9.1	8.7	9.6	2	150	150	1	7.5	6.9
1N5347B	10	9.5	10.5	2	125	125	1	5	7.6
1N5348B	11	10.5	11.6	2.5	125	125	1	5	8.4
1N5349B	12	11.4	12.6	2.5	100	125	1	2	9.1
1N5350B	13	12.4	13.7	2.5	100	100	1	1	9.9
1N5351B	14	13.3	14.7	2.5	100	75	1	1	10.6
1N5352B	15	14.3	15.8	2.5	75	75	1	1	11.5
1N5353B	16	15.2	16.8	2.5	75	75	1	1	12.2
1N5354B	17	16.2	17.9	2.5	70	75	1	0.5	12.9
1N5355B	18	17.1	18.9	2.5	65	75	1	0.5	13.7
1N5356B	19	18.1	20	3	65	75	1	0.5	14.4
1N5357B	20	19	21	3	65	75	1	0.5	15.2
1N5358B	22	20.9	23.1	3.5	50	75	1	0.5	16.7
1N5359B	24	22.8	25.2	3.5	50	100	1	0.5	18.2
1N5360B	25	23.8	26.3	4	50	110	1	0.5	19
1N5361B	27	25.7	28.4	5	50	120	1	0.5	20.6
1N5362B	28	26.6	29.4	6	50	130	1	0.5	21.2
1N5363B	30	28.5	32	8	40	140	1	0.5	22.8
1N5364B	33	31.4	34.7	10	40	150	1	0.5	25.1
1N5365B	36	34.2	37.8	11	30	160	1	0.5	27.4
1N5366B	39	37.1	41	14	30	170	1	0.5	29.7
1N5367B	43	40.9	45	20	30	190	1	0.5	32.7
1N5368B	47	44.7	49	25	25	210	1	0.5	35.8
1N5369B	51	48.5	53.6	27	25	230	1	0.5	38.8
1N5370B	56	53.2	58.8	35	20	280	1	0.5	42.6
1N5371B	60	57	63	40	20	350	1	0.5	45.5



Part Number	Nominal Zener Voltage			Maximum Zener Impedance				Maximum Leakage Current	
	V _Z @ I _{ZT}			Z _{ZT} @ I _{ZT}		Z _{ZK} @ I _{ZK}		I _R	V _R
	Nom. V	Min. V	Max. V	Ohms	mA	Ohms	mA	μA	V
1N5372B	62	58.9	65.1	42	20	400	1	0.5	47.1
1N5373B	68	64.6	71.4	44	20	500	1	0.5	51.7
1N5374B	75	71.3	78.8	45	20	620	1	0.5	56
1N5375B	82	77.9	86.1	65	15	720	1	0.5	62.2
1N5376B	87	82.7	91.4	75	15	760	1	0.5	66
1N5377B	91	86.5	95.6	75	15	760	1	0.5	69.2
1N5378B	100	95	105	90	12	800	1	0.5	76



RATING AND CHARACTERISTIC CURVES

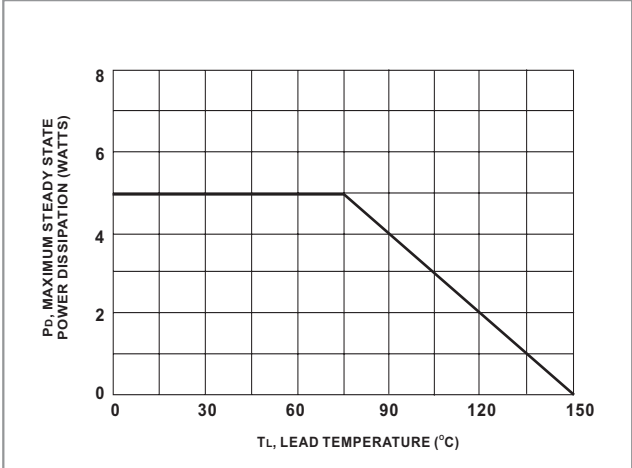

Fig.1 Power temperature Derating Curve

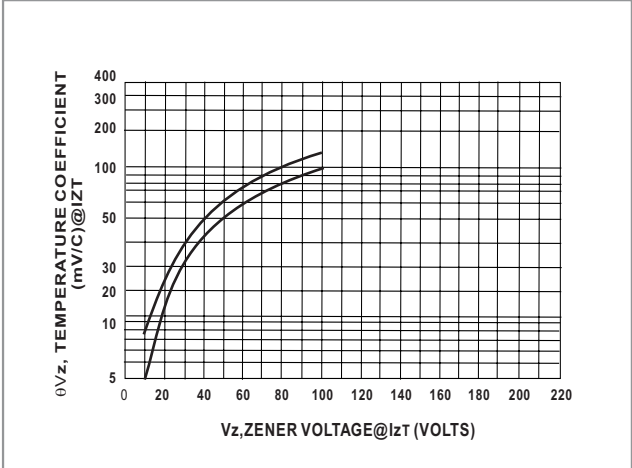

Fig.2 Temperature Coefficient-Range for Units 10 to 100 Volts

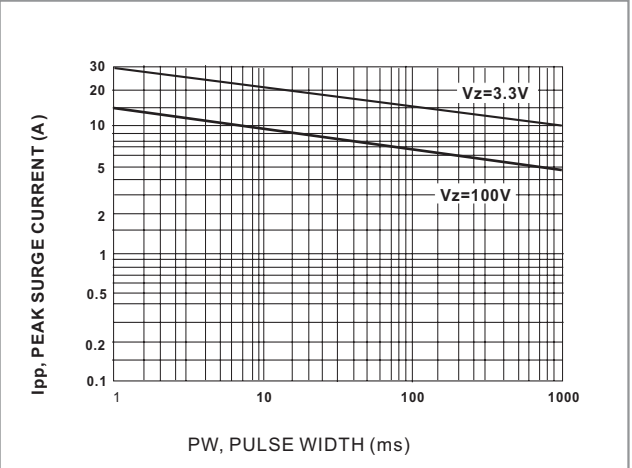

Fig.3 Peak Surge Current versus Pulse Width

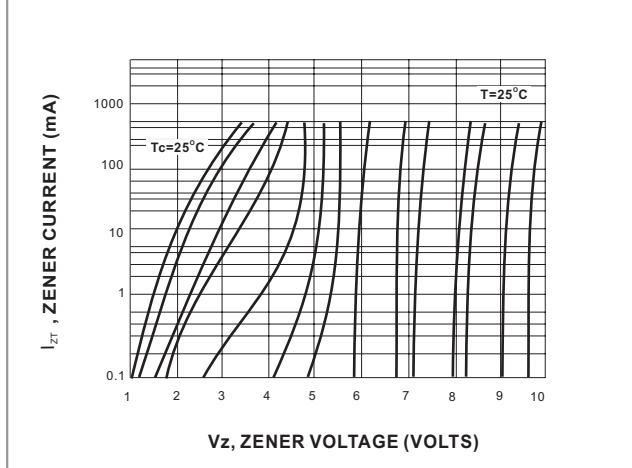

Fig.4 Zener Voltage versus Zener Current Vz=3.3 Thru 10 Volts

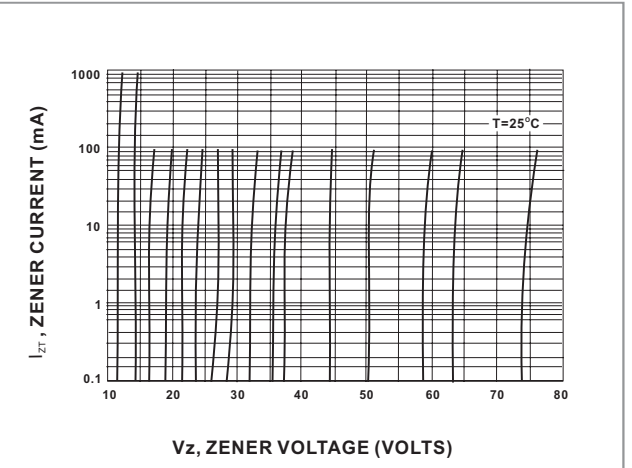

Fig.5 Zener Voltage versus Zener Current Vz=11 Thru 75 Volts

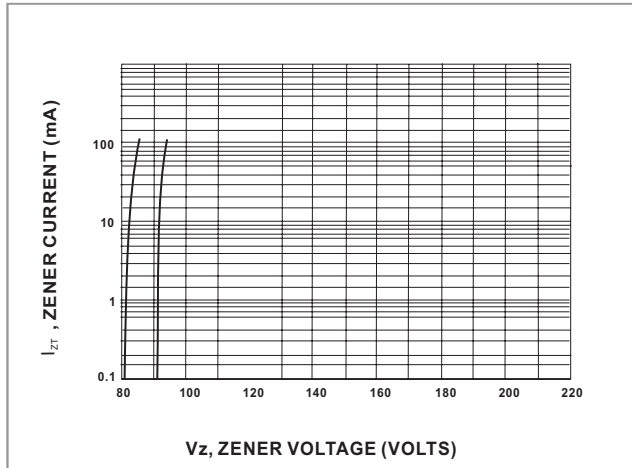

Fig.6 Zener Voltage versus Zener Current Vz=82 Thru 100 Volts