

1N5817W-1N5819W

■ Features

- For use in low voltage, high frequency inverters
- Free wheeling, and polarity protection applications.

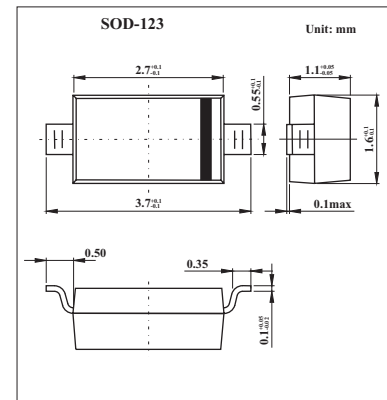

■ Absolute Maximum Ratings Ta = 25°C

Parameter	Symbol	1N5817W	1N5818W	1N5819W	Unit
Non-Repetitive Peak reverse voltage	V _{RM}	20	30	40	V
Peak repetitive Peak reverse voltage	V _{RRM}				V
Working Peak Reverse Voltage	V _{RWM}	20	30	40	V
DC Blocking Voltage	V _R				V
RMS Reverse Voltage	V _{R(RMS)}	14	21	28	V
Average Rectified Output Current	I _O	1			A
Peak forward surge current @=8.3ms	I _{FSM}	25			A
Repetitive Peak Forward Current	I _{FRM}	625			mA
Power Dissipation	P _d	250			mW
Thermal Resistance Junction to Ambient	R _{θJA}	500			K/W
Storage temperature	T _{STG}	-65 to 150			°C

■ Electrical Characteristics Ta = 25°C

Parameter	Symbol	Testconditions	Min	Typ	Max	Unit
Reverse breakdown voltage	1N5817W	I _R = 1mA	20			V
	1N5818W		30			
	1N5819W		40			
Reverse voltage leakage current	1N5817W	V _R =20V V _R =30V V _R =40V			1	mA
	1N5818W					
	1N5819W					
Forward voltage	1N5817W	V _F	I _F =1A		0.45	V
			I _F =3A		0.75	
	1N5818W		I _F =1A		0.55	V
			I _F =3A		0.875	
	1N5819W		I _F =1A		0.6	V
			I _F =3A		0.9	
Diode capacitance	C _D	V _R =4V, f=1MHz			120	pF

■ Marking

NO.	1N5817W	1N5818W	1N5819W
Marking	SJ	SK	SL



1N5817W-1N5819W

■ Typical Characteristics

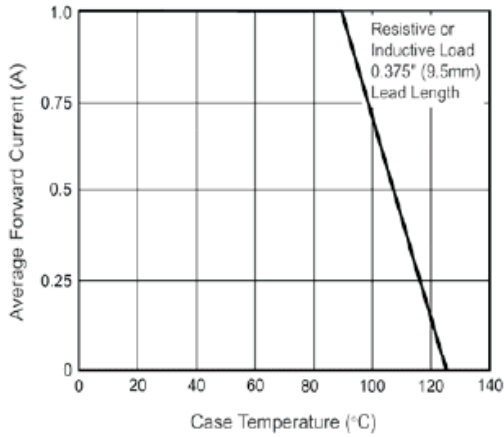

Fig.1 Forward Current Derating Curve

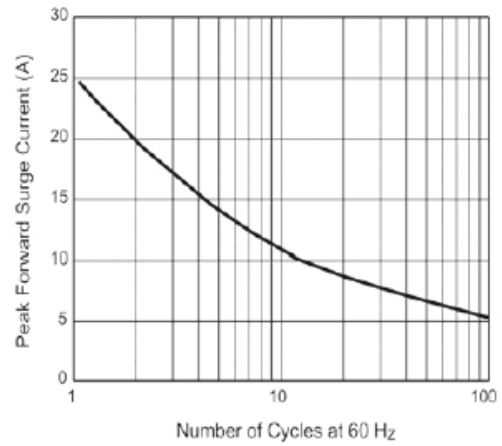

Fig.2 Maximum Non-Repetitive Peak Forward Surge Current

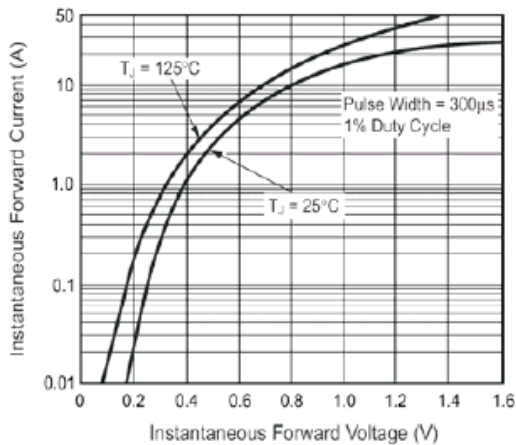

Fig.3 Typical Instantaneous Forward Characteristics

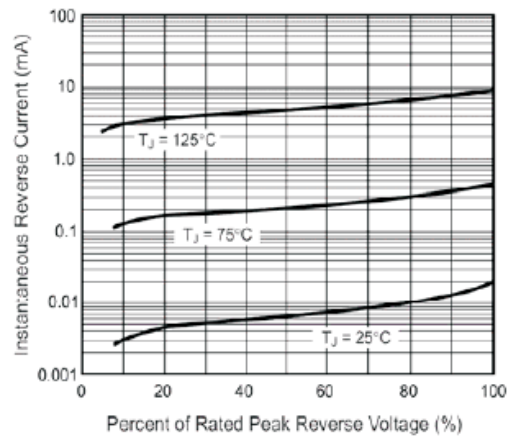

Fig.4 Typical Reverse Characteristics

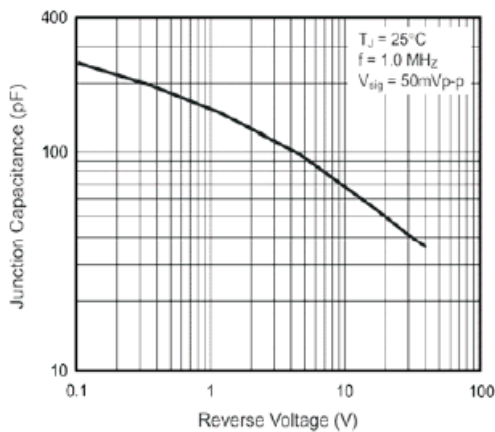

Fig.5 Typical Junction Capacitance

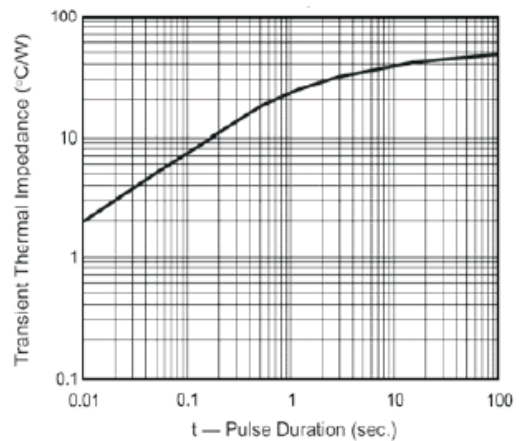

Fig.6 Typical Transient Thermal Impedance