

Features

- Glass Passivated Die Construction
- 1.0W Power Dissipation
- 3.3V – 330V Nominal Zener Voltage
- 5% Standard Vz Tolerance
- Low Inductance
- For Use in Voltage Regulator or Reference
- Plastic Case Material has UL Flammability Classification Rating 94V-0

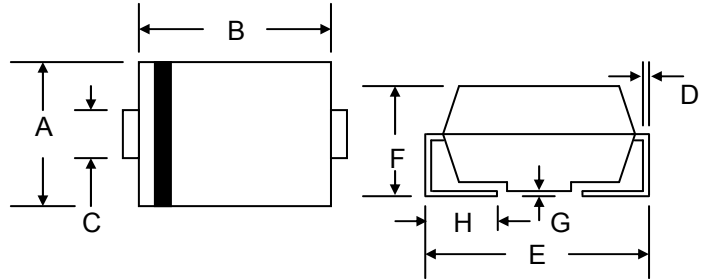

Mechanical Data

- Case: SMA/DO-214AC, Molded Plastic
- Terminals: Solder Plated, Solderable per MIL-STD-750, Method 2026
- Polarity: Cathode Band
- Marking: Device Code
- Weight: 0.064 grams (approx.)
- **Lead Free: For RoHS / Lead Free Version, Add "-LF" Suffix to Part Number, See Page 5**

SMA/DO-214AC		
Dim	Min	Max
A	2.29	2.92
B	4.00	4.60
C	1.27	1.90
D	0.152	0.305
E	4.80	5.30
F	2.00	2.44
G	0.051	0.203
H	0.76	1.52
All Dimensions in mm		

Maximum Ratings @ $T_A=25^{\circ}\text{C}$ unless otherwise specified

Characteristic	Symbol	Value	Unit
Power Dissipation at $T_L = 75^{\circ}\text{C}$ (Note 1)	P_D	1.0	W
Forward Voltage @ $I_F = 200\text{mA}$	V_F	1.2	V
Thermal Resistance, Junction to Ambient (Note 2)	R_{JA}	125	$^{\circ}\text{C/W}$
Thermal Resistance, Junction to Lead (Note 2)	R_{JL}	30	$^{\circ}\text{C/W}$
Operating and Storage Temperature Range	T_J, T_{STG}	-65 to +150	$^{\circ}\text{C}$

- Note: 1. Mounted on FR-4 PCB with 8.0 x 8.0 x 2.0mm copper pads.
 2. Mounted on 25.4 x 21.6 x 1.6mm ceramic substrate with minimum recommended pad layout.

1SMA4728A – SZ1330A

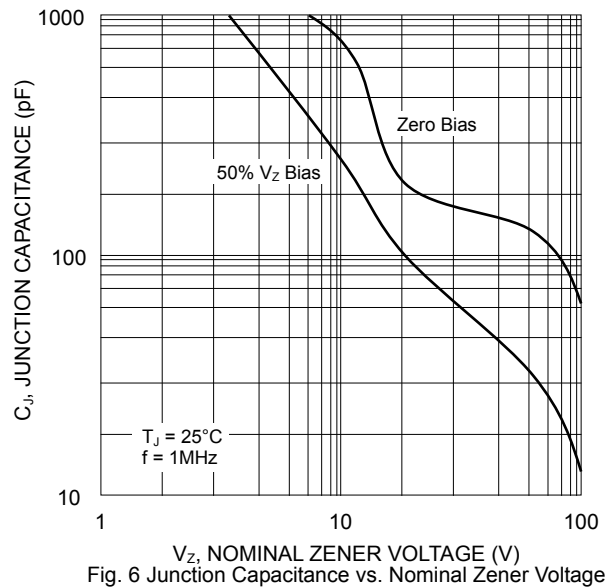
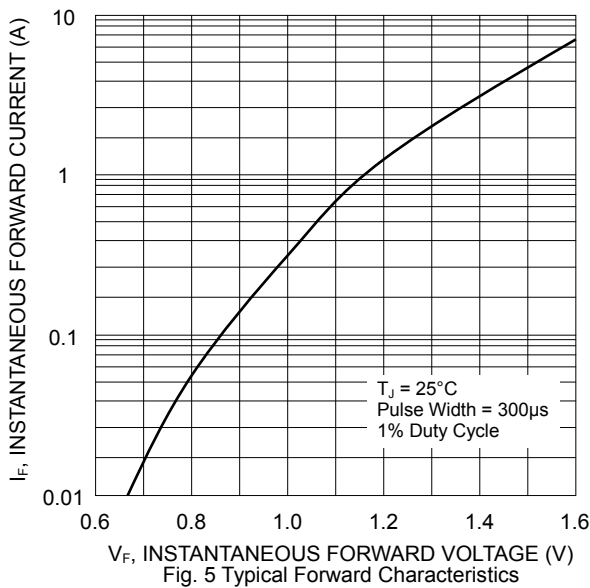
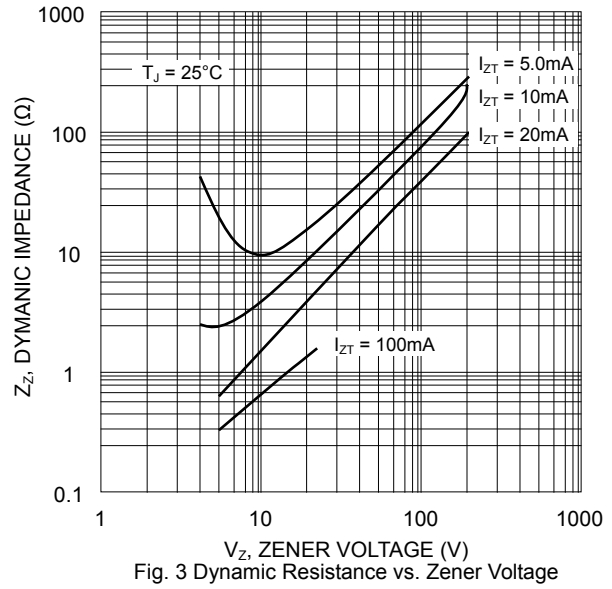
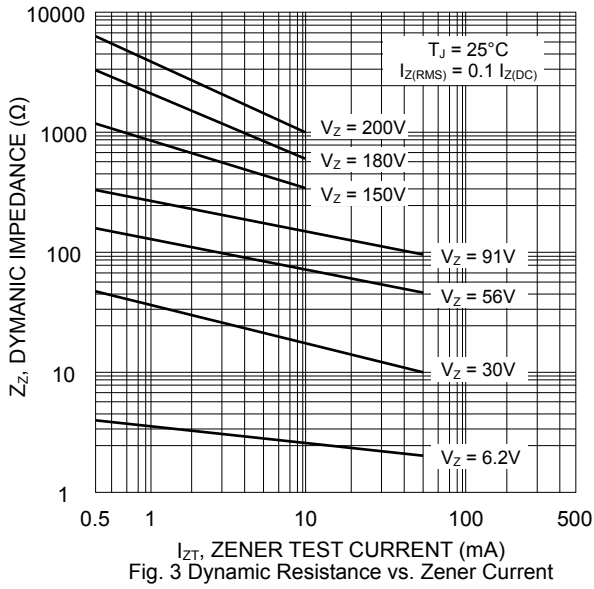
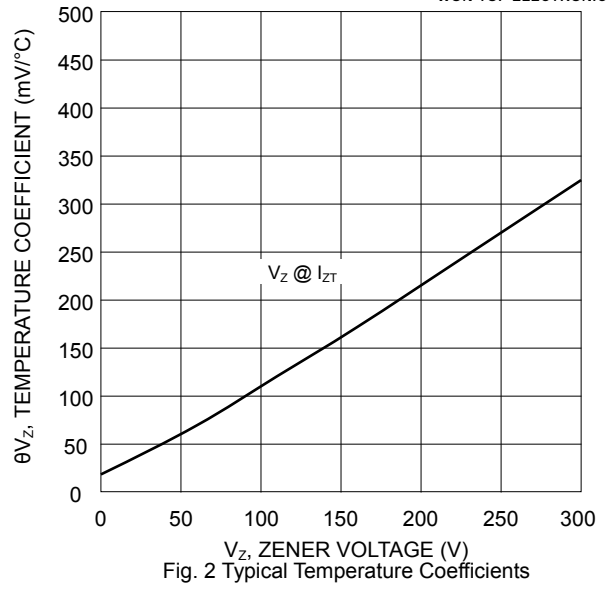
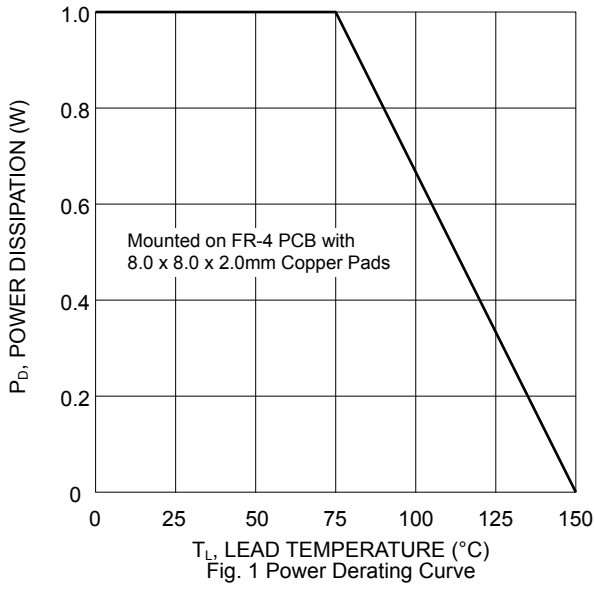

Electrical Characteristics (@T_A=25°C unless otherwise specified) Table 1

Type Number (Note 1)	Device Marking Code	Nominal Zener Voltage (Note 2)	Test Current	Maximum Zener Impedance (Note 3)			Maximum Leakage Current		Max DC Zener Current	Max Surge Current 8.3ms
		V _Z @ I _{ZT}	I _{ZT}	Z _{ZT} @ I _{ZT}	Z _{ZK} @ I _{ZK}	I _{ZK}	I _R @ V _R		I _{ZM}	I _{ZS}
		(V)	(mA)	(Ω)	(Ω)	(mA)	(μ A)	(V)	(mA)	(mA)
1SMA4728A	28A	3.3	76.0	10	400	1.00	100	1.0	276	1380
1SMA4729A	29A	3.6	69.0	10	400	1.00	100	1.0	252	1260
1SMA4730A	30A	3.9	64.0	9.0	400	1.00	50	1.0	234	1190
1SMA4731A	31A	4.3	58.0	9.0	400	1.00	10	1.0	217	1070
1SMA4732A	32A	4.7	53.0	8.0	500	1.00	10	1.0	193	970
1SMA4733A	33A	5.1	49.0	7.0	550	1.00	10	1.0	178	890
1SMA4734A	34A	5.6	45.0	5.0	600	1.00	10	2.0	162	810
1SMA4735A	35A	6.2	41.0	2.0	700	1.00	10	3.0	146	730
1SMA4736A	36A	6.8	37.0	3.5	700	1.00	10	4.0	133	660
1SMA4737A	37A	7.5	34.0	4.0	700	0.50	10	5.0	121	605
1SMA4738A	38A	8.2	31.0	4.5	700	0.50	10	6.0	110	550
1SMA4739A	39A	9.1	28.0	5.0	700	0.50	10	7.0	100	500
1SMA4740A	40A	10	25.0	7.0	700	0.25	10	7.6	91	454
1SMA4741A	41A	11	23.0	8.0	700	0.25	5	8.4	83	414
1SMA4742A	42A	12	21.0	9.0	700	0.25	5	9.1	76	380
1SMA4743A	43A	13	19.0	10	700	0.25	5	9.9	69	344
1SMA4744A	44A	15	17.0	14	700	0.25	5	11.4	61	304
1SMA4745A	45A	16	15.5	16	700	0.25	5	12.2	57	285
1SMA4746A	46A	18	14.0	20	750	0.25	5	13.7	50	250
1SMA4747A	47A	20	12.5	22	750	0.25	5	15.2	45	225
1SMA4748A	48A	22	11.5	23	750	0.25	5	16.7	41	205
1SMA4749A	49A	24	10.5	25	750	0.25	5	18.2	38	190
1SMA4750A	50A	27	9.5	35	750	0.25	5	20.6	34	170
1SMA4751A	51A	30	8.5	40	1000	0.25	5	22.8	30	150
1SMA4752A	52A	33	7.5	45	1000	0.25	5	25.1	27	135
1SMA4753A	53A	36	7.0	50	1000	0.25	5	27.4	25	125
1SMA4754A	54A	39	6.5	60	1000	0.25	5	29.7	23	115
1SMA4755A	55A	43	6.0	70	1500	0.25	5	32.7	22	110
1SMA4756A	56A	47	5.5	80	1500	0.25	5	35.8	19	95
1SMA4757A	57A	51	5.0	95	1500	0.25	5	38.8	18	90
1SMA4758A	58A	56	4.5	110	2000	0.25	5	42.6	16	80
1SMA4759A	59A	62	4.0	125	2000	0.25	5	47.1	14	70
1SMA4760A	60A	68	3.7	150	2000	0.25	5	51.7	13	65
1SMA4761A	61A	75	3.3	175	2000	0.25	5	56.0	12	60
1SMA4762A	62A	82	3.0	200	3000	0.25	5	62.2	11	55
1SMA4763A	63A	91	2.8	250	3000	0.25	5	69.2	10	50
1SMA4764A	64A	100	2.5	350	3000	0.25	5	76.0	9.0	45
SZ1110A	11Z	110	2.3	450	4000	0.25	5	83.6	8.6	40
SZ1120A	12Z	120	2.0	550	4500	0.25	5	91.2	7.8	37
SZ1130A	13Z	130	1.9	700	5000	0.25	5	98.8	7.0	34
SZ1150A	15Z	150	1.7	1000	6000	0.25	5	114.0	6.4	30
SZ1160A	16Z	160	1.6	1100	6500	0.25	5	121.6	5.8	28
SZ1180A	18Z	180	1.4	1200	7000	0.25	5	136.8	5.2	25
SZ1200A	20Z	200	1.2	1900	9990	0.25	5	152.0	4.7	22
SZ1220A	22Z	220	1.0	1600	8000	0.25	5	167.2	4.0	20
SZ1240A	24Z	240	0.9	1800	8500	0.25	5	182.4	3.8	19
SZ1250A	25Z	250	0.9	2000	9000	0.25	5	190.0	3.6	18
SZ1270A	27Z	270	0.8	2100	9000	0.25	5	205.0	3.3	16
SZ1300A	30Z	300	0.8	2300	9500	0.25	5	228.0	3.0	15
SZ1330A	33Z	330	0.7	2500	9500	0.25	5	250.2	2.7	13

Note: 1. Type numbers listed have standard tolerance on the nominal zener voltage of $\pm 5\%$.
 2. Measured under thermal equilibrium and DC (I_{ZT}) test conditions.
 3. f = 1KHz

MARKING INFORMATION



Cathode = Polarity Band
xx = Device Code, See Table 1

RECOMMENDED FOOTPRINT

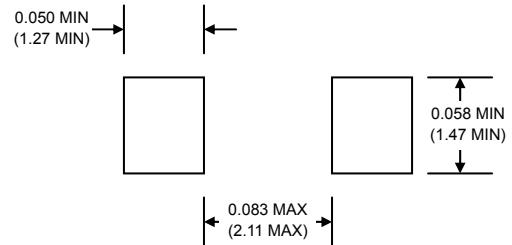

inches(mm)

PACKAGING INFORMATION

TAPE & REEL

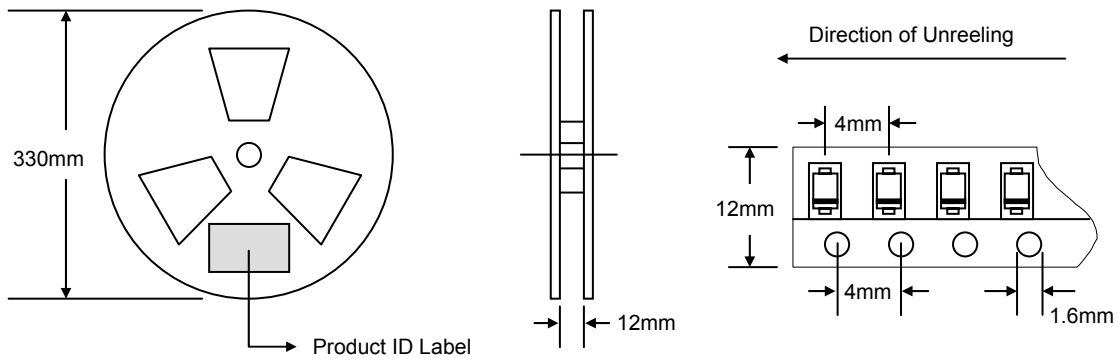

Reel Diameter (mm)	Quantity (PCS)	Inner Box Size L x W x H (mm)	Quantity (PCS)	Carton Size L x W x H (mm)	Quantity (PCS)	Approx. Gross Weight (KG)
330	5,000	340 x 337 x 45	10,000	370 x 370 x 420	80,000	14.0

Note: 1. Paper reel, white or gray color.
2. Components are packed in accordance with EIA standard 481-1 and 481-2.

ORDERING INFORMATION

Product No.	Package Type	Shipping Quantity
1SMA47xxA-T3	SMA	5000/Tape & Reel

1. Shipping quantity given is for minimum packing quantity only. For minimum order quantity, please consult the Sales Department.
2. **To order RoHS / Lead Free version (with Lead Free finish), add "-LF" suffix to part number above. For example, 1SMA4728A-T3-LF.**

WON-TOP ELECTRONICS and  are registered trademarks of Won-Top Electronics Co., Ltd (WTE). WTE has checked all information carefully and believes it to be correct and accurate. However, WTE cannot assume any responsibility for inaccuracies. Furthermore, this information does not give the purchaser of semiconductor devices any license under patent rights to manufacturer. WTE reserves the right to change any or all information herein without further notice.

WARNING: DO NOT USE IN LIFE SUPPORT EQUIPMENT. WTE power semiconductor products are not authorized for use as critical components in life support devices or systems without the express written approval.

Won-Top Electronics Co., Ltd.
No. 44 Yu Kang North 3rd Road,
Chine Chen Dist., Kaohsiung 806, Taiwan
Phone: 886-7-822-5408 or 886-7-822-5410
Fax: 886-7-822-5417
Email: sales@wontop.com
Internet: <http://www.wontop.com>

We power your everyday.