

1SMB5926 THRU 1SMB5956

SURFACE MOUNT SILICON ZENER DIODE

VOLTAGE - 11 TO 200 Volts Power - 1.5 Watts

FEATURES

- For surface mounted applications in order to optimize board space

- Low profile package

- Built-in strain relief

- Glass passivated junction

- Low inductance

- Typical I_R less than 1 A above 11V

- High temperature soldering :

260 /10 seconds at terminals

- Plastic package has Underwriters Laboratory

Flammability Classification 94V-O

DO-214AA

MODIFIED J-BEND

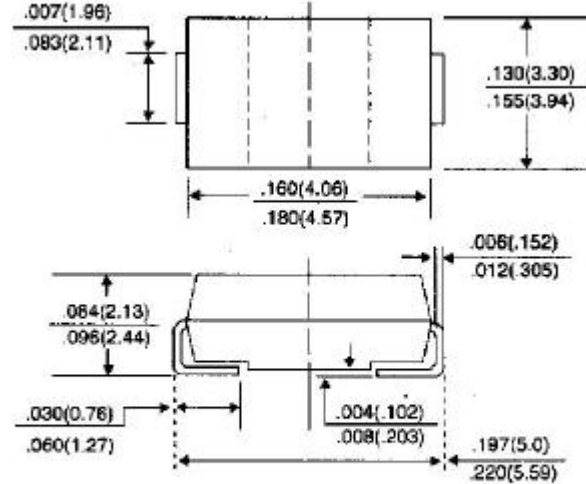

Dimensions in inches and (millimeters)

MECHANICAL DATA

Case: JEDEC DO-214AA Molded plastic over passivated junction

Terminals: Solder plated, solderable per MIL-STD-750, method 2026

Polarity: Color band denotes positive end (cathode)

Standard Packaging: 12mm tape (EIA-481)

Weight: 0.003 ounce, 0.093 gram

MAXIMUM RATINGS AND ELECTRICAL CHARACTERISTICS

Ratings at 25 ambient temperature unless otherwise specified.

	SYMBOL	VALUE	UNITS
DC Power Dissipation @ $T_L=75$, Measure at Zero Lead Length(Note 1, Fig. 1) Derate above 75	P_D	1.5 15	Watts mW/
Peak forward Surge Current 8.3ms single half sine-wave superimposed on rated load(JEDEC Method) (Note 1,2)	I_{FSM}	10	Amps
Operating Junction and Storage Temperature Range	T_J, T_{STG}	-55 to +150	

NOTES:

1. Mounted on 5.0mm^2 (.013mm thick) land areas.

2. Measured on 8.3ms, single half sine-wave or equivalent square wave, duty cycle = 4 pulses per minute maximum.

3. ZENER VOLTAGE (V_Z) MEASUREMENT Nominal zener voltage is measured with the device function in thermal equilibrium with ambient temperature at 25 .

4.ZENER IMPEDANCE (Z_Z) DERIVATION Z_{ZT} and Z_{ZK} are measured by dividing the ac voltage drop across the device by the accurent applied. The specified limits are for $I_{Z(ac)} = 0.1 I_Z$, (dc) with the ac frequency = 60Hz.

1SMB5926 THRU 1SMB5956

ELECTRICAL CHARACTERISTICS (T_L=30 unless otherwise noted) (V_F=1.5Volts Max @ I_F=200mAdc for all types.)

Device	Nominal Zener Voltage V _Z @ I _{ZT} volts (Note 1.)	Test current I _{ZT} mA	Maximum Zener Impedance (Note 2.)			Max reverse Leakage Current			Maximum DC Zener Current I _{ZM} mAdc	Device Marking Code
			Z _{ZT} @ I _{ZT} Ohms	Z _{ZK} @ I _{ZK} Ohms	I _{ZK} mA	I _R A	V _R Volts			
1SMB5926	11	34.1	5.5	550	0.25	1	8.4	136	926B	
1SMB5927	12	31.2	6.5	550	0.25	1	9.1	125	927B	
1SMB5928	13	28.8	7	550	0.25	1	9.9	115	928B	
1SMB5929	15	25	9	600	0.25	1	11.4	100	929B	
1SMB5930	16	23.4	10	600	0.25	1	12.2	93	930B	
1SMB5931	18	20.8	12	650	0.25	1	13.7	83	931B	
1SMB5932	20	18.7	14	650	0.25	1	15.2	75	932B	
1SMB5933	22	17	17.5	650	0.25	1	16.7	68	933B	
1SMB5934	24	15.6	19	700	0.25	1	18.2	62	934B	
1SMB5935	27	13.9	23	700	0.25	1	20.6	55	935B	
1SMB5936	30	12.5	26	750	0.25	1	22.8	50	936B	
1SMB5937	33	11.4	33	800	0.25	1	25.1	45	937B	
1SMB5938	36	10.4	38	850	0.25	1	27.4	41	938B	
1SMB5939	39	9.6	45	900	0.25	1	29.7	38	939B	
1SMB5940	43	8.7	53	950	0.25	1	32.7	34	940B	
1SMB5941	47	8	67	1000	0.25	1	35.8	31	941B	
1SMB5942	51	7.3	70	1100	0.25	1	38.8	29	942B	
1SMB5943	56	6.7	86	1300	0.25	1	42.6	26	943B	
1SMB5944	62	6	100	1500	0.25	1	47.1	24	944B	
1SMB5945	68	5.5	120	1700	0.25	1	51.7	22	945B	
1SMB5946	75	5	140	2000	0.25	1	56	20	946B	
1SMB5947	82	4.6	160	2500	0.25	1	62.2	18	947B	
1SMB5948	91	4.1	200	3000	0.25	1	69.2	16	948B	
1SMB5949	100	3.7	250	3100	0.25	1	76	15	949B	
1SMB5950	110	3.4	300	4000	0.25	1	83.6	13	950B	
1SMB5951	120	3.1	380	4500	0.25	1	91.2	12	951B	
1SMB5952	130	2.9	450	5000	0.25	1	98.8	11	952B	
1SMB5953	150	2.5	600	6000	0.25	1	114	10	953B	
1SMB5954	160	2.3	700	6500	0.25	1	121.6	9	954B	
1SMB5955	180	2.1	900	7000	0.25	1	136.8	8	955B	
1SMB5956	200	1.9	1200	8000	0.25	1	152	7	956B	

* TOLERANCE AND VOLTAGE DESIGNATION Tolerance designation - The type numbers listed indicate a tolerance of ±5%

RATING AND CHARACTERISTICS CURVES

1SMB5926 THRU 1SMB5956

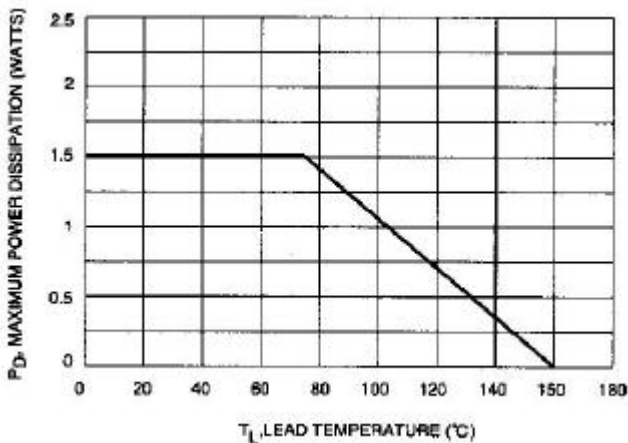

Fig. 1-STEADY STATE POWER DERATING

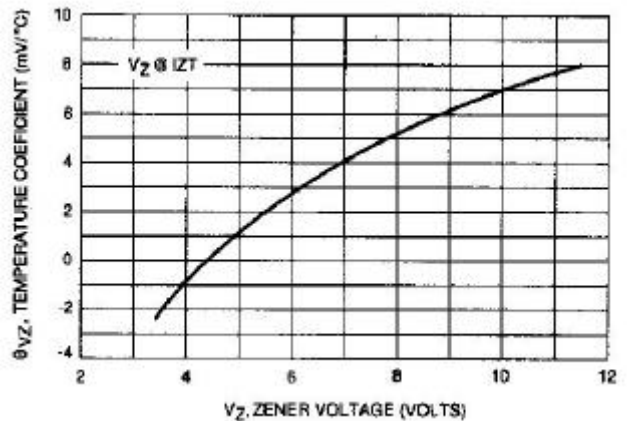

Fig. 2-ZENER VOLTAGE TO 12 VOLTS

RATING AND CHARACTERISTICS CURVES

1SMB5926 THRU 1SMB5956

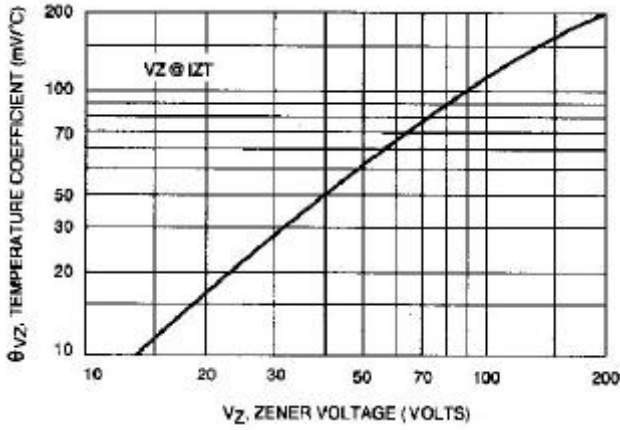

Fig. 3-ZENER VOLTAGE 14 TO 200 VOLTS

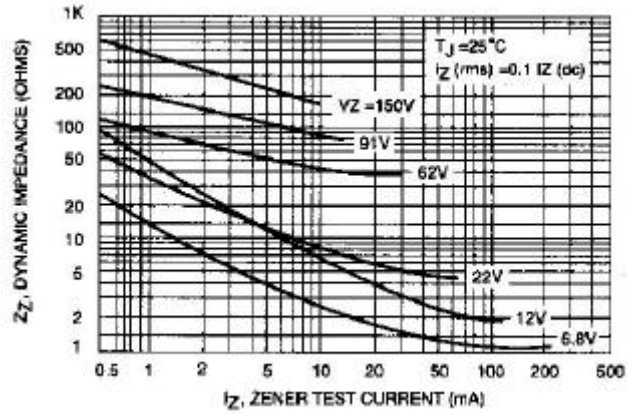

Fig. 4-EFFECT OF ZENER CURRENT

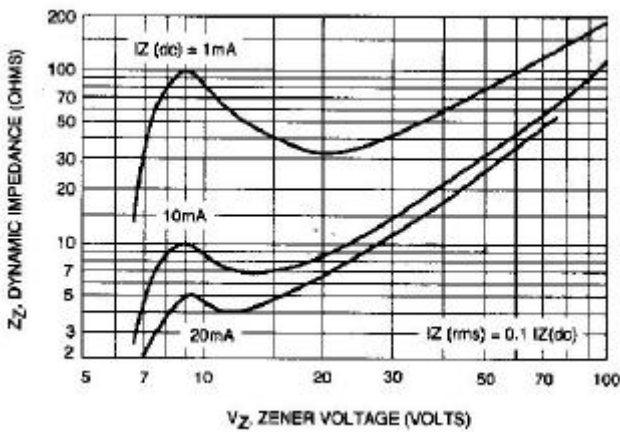

Fig. 5-EFFECT OF ZENER VOLTAGE

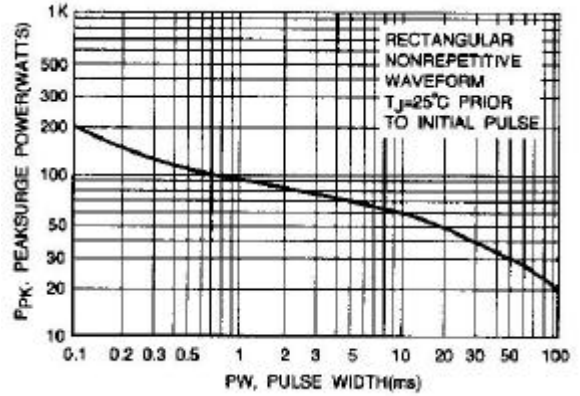

Fig. 6-MAXIMUM SURGE POWER

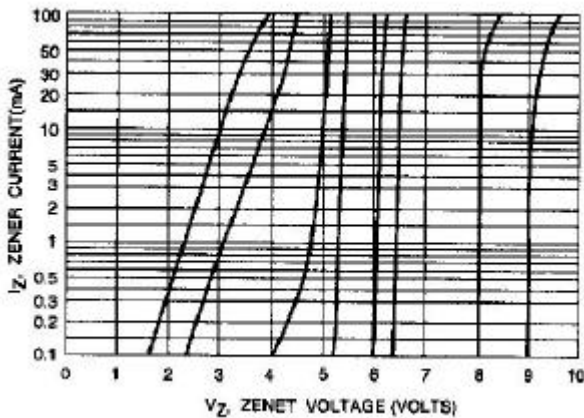

Fig. 7- $V_z = 6.8$ THRU 10 VOLTS

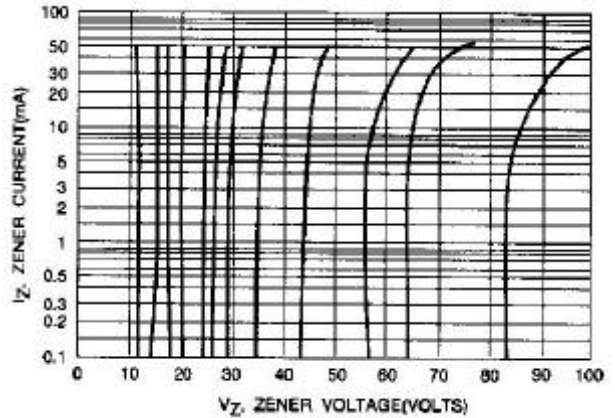

Fig. 8- $V_z = 12$ THRU 82 VOLTS