

Switching Diode

Lead free product
Halogen-free type

1SS355GH



MAXIMUM RATINGS (At TA = 25°C unless otherwise noted)

RATINGS	Symbol	1SS355GH	UNITS
Maximum Recurrent Peak Reverse Voltage	VRRM	90	Volts
Maximum RMS Voltage	VRMS	63	Volts
Maximum DC Blocking Voltage	VDC	80	Volts
Maximum Average Forward Rectified Current	Io	0.1	Amps
Peak Forward Surge Current at 1Sec.	IFSM	225	mA
Maximum Junction Capacitance between Terminal (Note 1)	CJ	3.0	pF
Maximum Reverse Recovery Time (Note 2)	TRR	4.0	nSec
Maximum Operating Temperature Range	TJ	+125	°C
Storage Temperature Range	TSTG	-55 to +125	°C

ELECTRICAL CHARACTERISTICS (At TA = 25°C unless otherwise noted)

CHARACTERISTICS	Symbol	1SS355GH	UNITS
Maximum Instantaneous Forward Voltage at IF= 100mA	VF	1.20	Volts
Maximum Average Reverse Current at VR= 80V	IR	0.1	uAmps

- NOTES :1. Measured at 1.0 MHZ and applied reverse voltage of 0.5 volts.
 2. Measured at applied forward current of 10mA and reverse voltage of 6.0 volts.
 3. ESD sensitive product handling required.

FIG. 1 - FORWARD CHARACTERISTICS

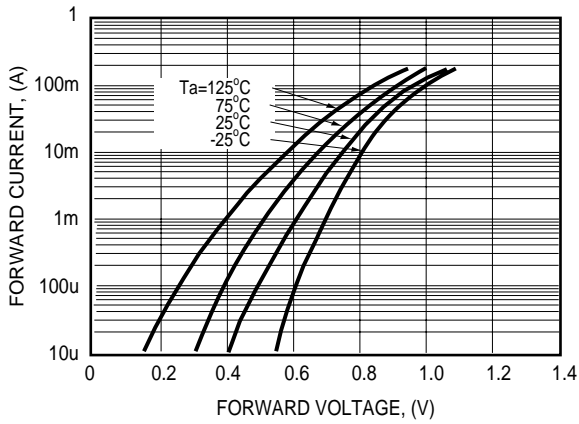

FIG. 2 - REVERSE CHARACTERISTICS

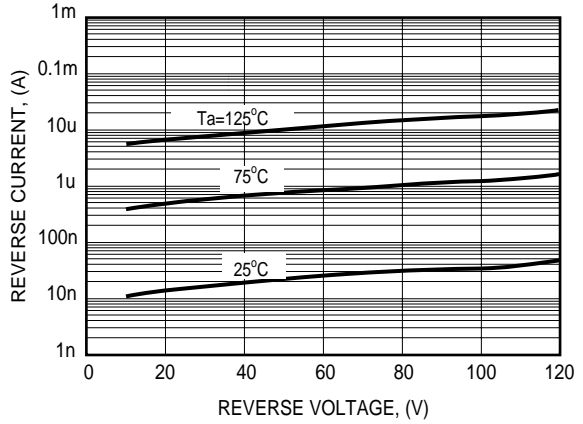

FIG. 3 - TYPICAL JUNCTION CAPACITANCE

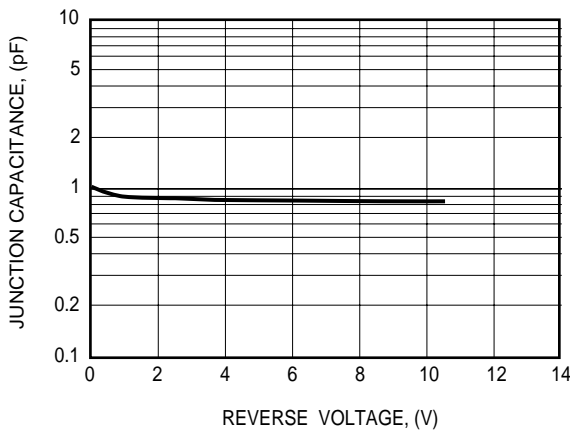

FIG. 4 - REVERSE RECOVERY TIME CHARACTERISTICS

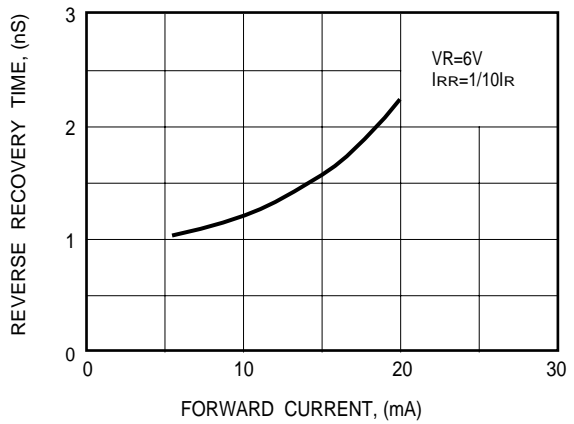

FIG. 5 - MAXIMUM NON-REPETITIVE FORWARD SURGE CURRENT

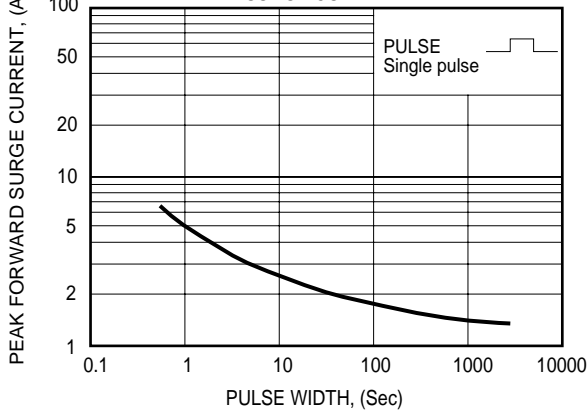
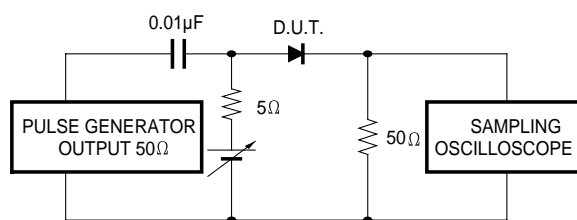

FIG. 6 - REVERSE RECOVERY TIME MEASUREMENT CIRCUIT



DEVICE MARKING AND ORDERING INFORMATION

Device	Marking	Reel	Reel (pcs)	Carton (pcs)	Packaging
1SS355GH	5D	7"	3,000	60,000 120,000	SOD-323

PACKAGE DIMENSIONS

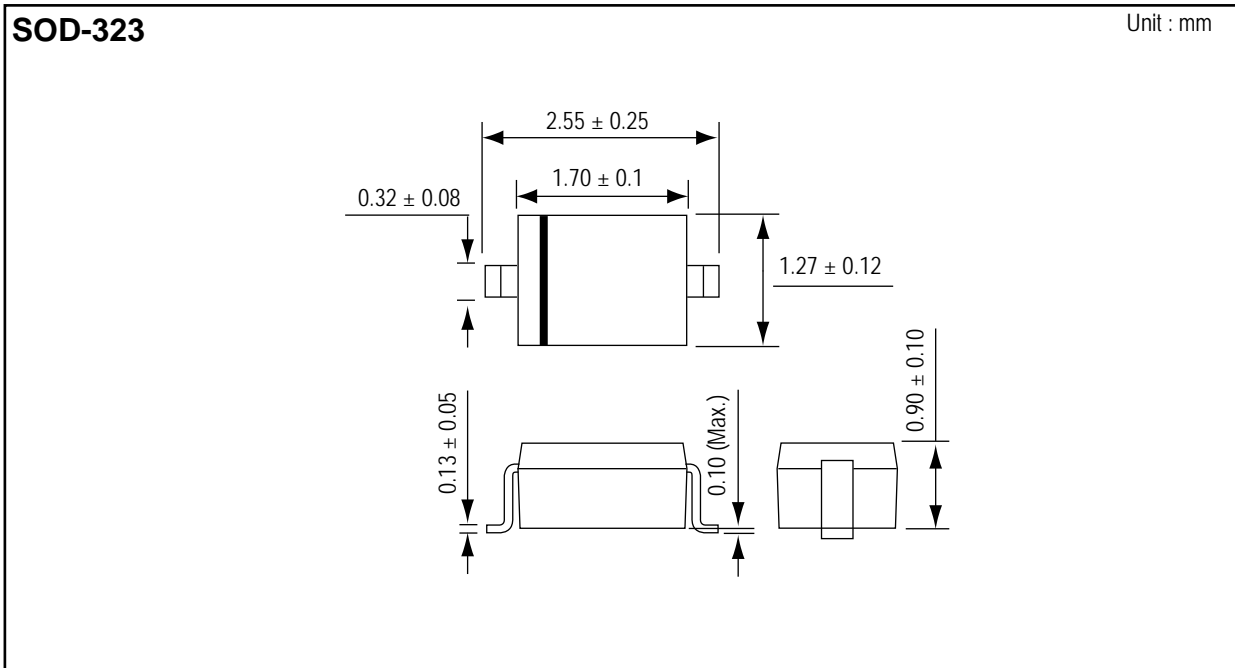

SOLDERING FOOTPRINT

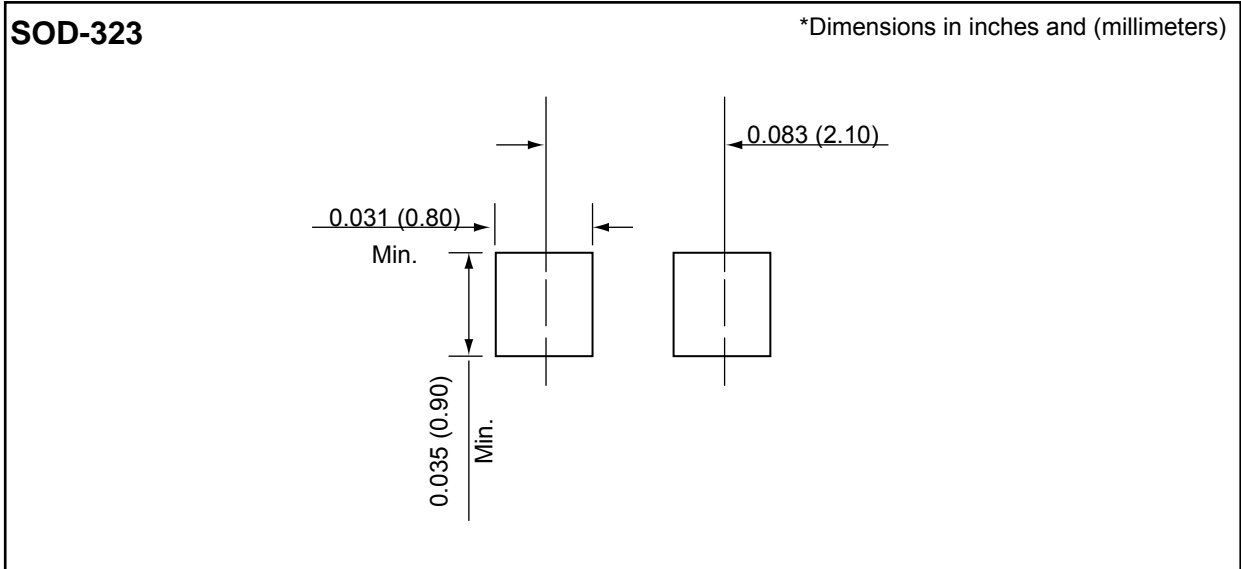

MARKING DIAGRAM

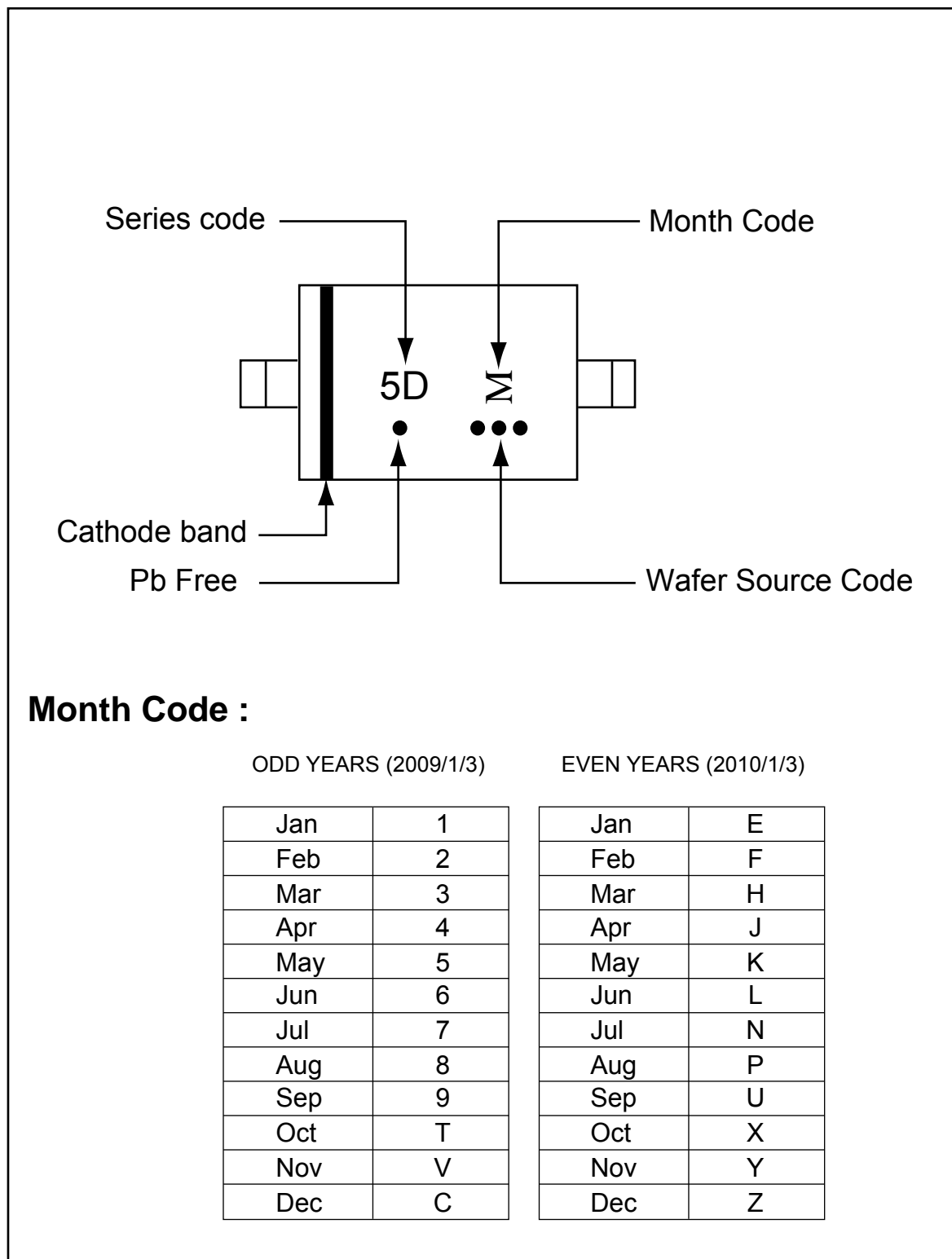

Month Code :

ODD YEARS (2009/1/3)

EVEN YEARS (2010/1/3)

Jan	1
Feb	2
Mar	3
Apr	4
May	5
Jun	6
Jul	7
Aug	8
Sep	9
Oct	T
Nov	V
Dec	C

Jan	E
Feb	F
Mar	H
Apr	J
May	K
Jun	L
Jul	N
Aug	P
Sep	U
Oct	X
Nov	Y
Dec	Z