

International
IR Rectifier

SAFEIR Series
20ETS12PbF

INPUT RECTIFIER DIODE
Lead-Free ("PbF" suffix)

Description/ Features

The 20ETS12PbF rectifier **SAFEIR** series has been optimized for very low forward voltage drop, with moderate leakage. The glass passivation technology used has reliable operation up to 150°C junction temperature.

Typical applications are in input rectification and these products are designed to be used with International Rectifier Switches and Output Rectifiers which are available in identical package outlines.

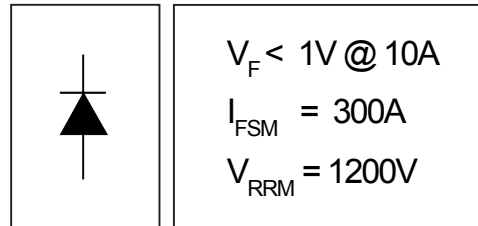

Output Current in Typical Applications

Applications	Single-phase Bridge	Three-phase Bridge	Units
Capacitive input filter $T_A = 55^\circ\text{C}$, $T_J = 125^\circ\text{C}$, common heatsink of 1°C/W	16.3	21	A

Major Ratings and Characteristics

Characteristics	Values	Units
$I_{F(AV)}$ Sinusoidal waveform	20	A
V_{RRM}	1200	V
I_{FSM}	300	A
V_F @10A, $T_J = 25^\circ\text{C}$	1.0	V
T_J	-40 to 150	$^\circ\text{C}$

Package Outline



Voltage Ratings

Part Number	V_{RRM} , maximum peak reverse voltage V	V_{RSM} , maximum non repetitive peak reverse voltage V	I_{RRM} 150°C mA
20ETS12PbF	1200	1300	1

Absolute Maximum Ratings

Parameters	20ETS..	Units	Conditions
$I_{F(AV)}$ Max. Average Forward Current	20	A	@ $T_C = 105^\circ\text{C}$, 180° conduction half sine wave
I_{FSM} Max. Peak One Cycle Non-Repetitive Surge Current	250	A	10ms Sine pulse, rated V_{RRM} applied
	300		10ms Sine pulse, no voltage reapplied
I^2t Max. I^2t for fusing	316	A^2s	10ms Sine pulse, rated V_{RRM} applied
	442		10ms Sine pulse, no voltage reapplied
$I^2\sqrt{t}$ Max. $I^2\sqrt{t}$ for fusing	4420	$A^2\sqrt{s}$	$t = 0.1$ to 10ms, no voltage reapplied

Electrical Specifications

Parameters	20ETS..	Units	Conditions
V_{FM} Max. Forward Voltage Drop	1.1	V	@ 20A, $T_J = 25^\circ\text{C}$
r_t Forward slope resistance	10.4	$m\Omega$	$T_J = 150^\circ\text{C}$
$V_{F(TO)}$ Threshold voltage	0.85	V	
I_{RM} Max. Reverse Leakage Current	0.1	mA	$T_J = 25^\circ\text{C}$
	1.0		$T_J = 150^\circ\text{C}$

$V_R = \text{rated } V_{RRM}$

Thermal-Mechanical Specifications

Parameters	20ETS..	Units	Conditions
T_J Max. Junction Temperature Range	-40 to 150	$^\circ\text{C}$	
T_{stg} Max. Storage Temperature Range	-40 to 150	$^\circ\text{C}$	
R_{thJC} Max. Thermal Resistance Junction to Case	1.3	$^\circ\text{C/W}$	DC operation
R_{thJA} Max. Thermal Resistance Junction to Ambient	62	$^\circ\text{C/W}$	(*) For D ² Pak version
R_{thCS} Typ. Thermal Resistance Case to Heatsink	0.5	$^\circ\text{C/W}$	Mounting surface, smooth and greased
wt Approximate Weight	2 (0.07)	g (oz.)	
T Mounting Torque	Min.	6 (5)	Kg-cm (lbf-in)
	Max.	12 (10)	
Case Style	TO-220AC		
Device Marking	10ETS12		

* When mounted on 1" square (650mm²) PCB of FR-4 or G-10 material 4 oz (140µm) copper 40°C/W
For recommended footprint and soldering techniques refer to application note #AN-994

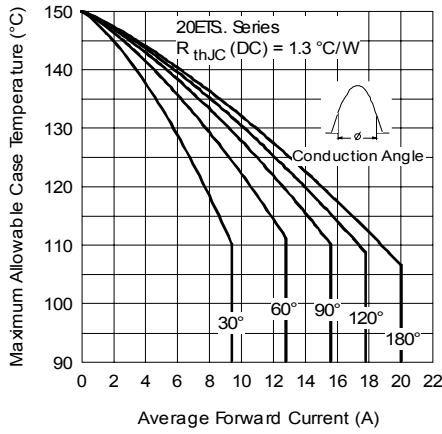

Fig. 1 - Current Rating Characteristics

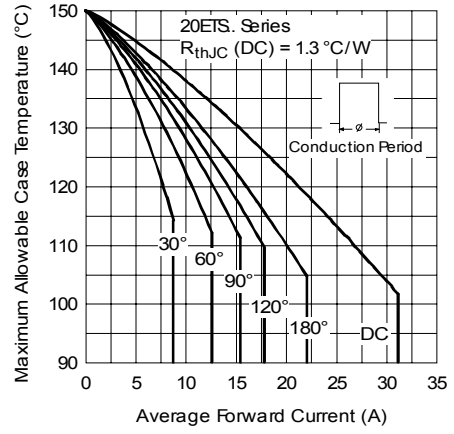

Fig. 2 - Current Rating Characteristics

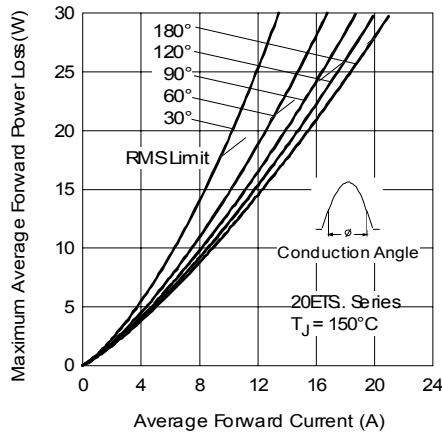

Fig. 3 - Forward Power Loss Characteristics

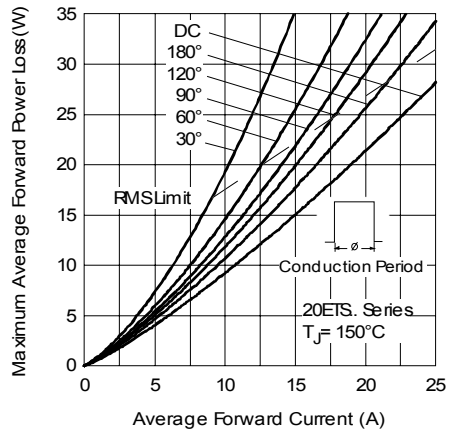

Fig. 4 - Forward Power Loss Characteristics

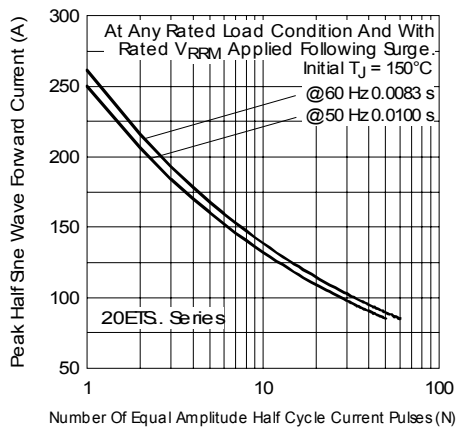

Fig. 5 - Maximum Non-Repetitive Surge Current

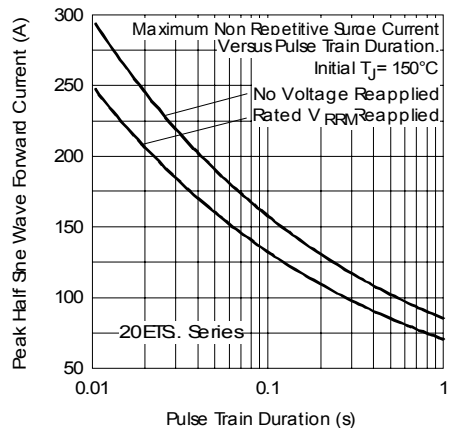

Fig. 6 - Maximum Non-Repetitive Surge Current

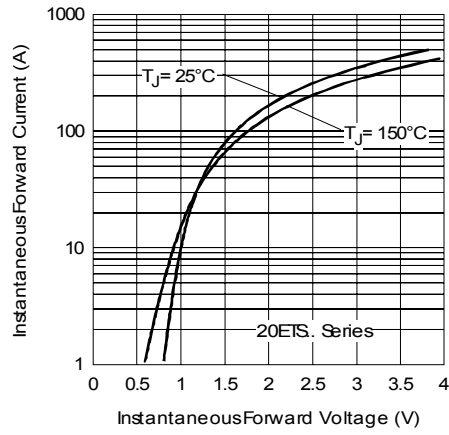

Fig. 7 - Forward Voltage Drop Characteristics

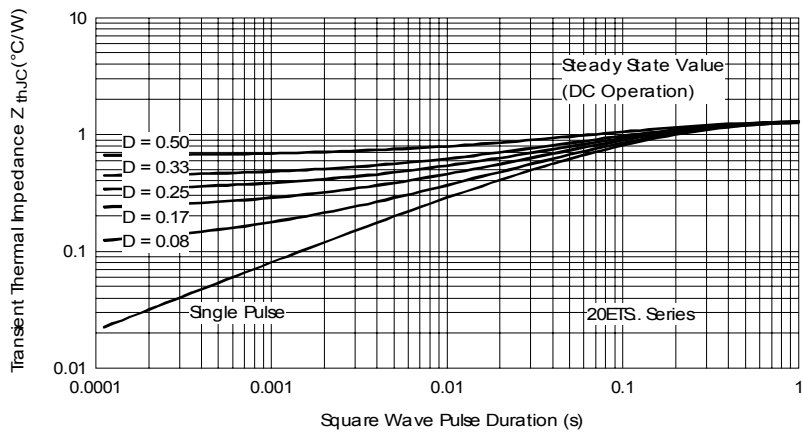
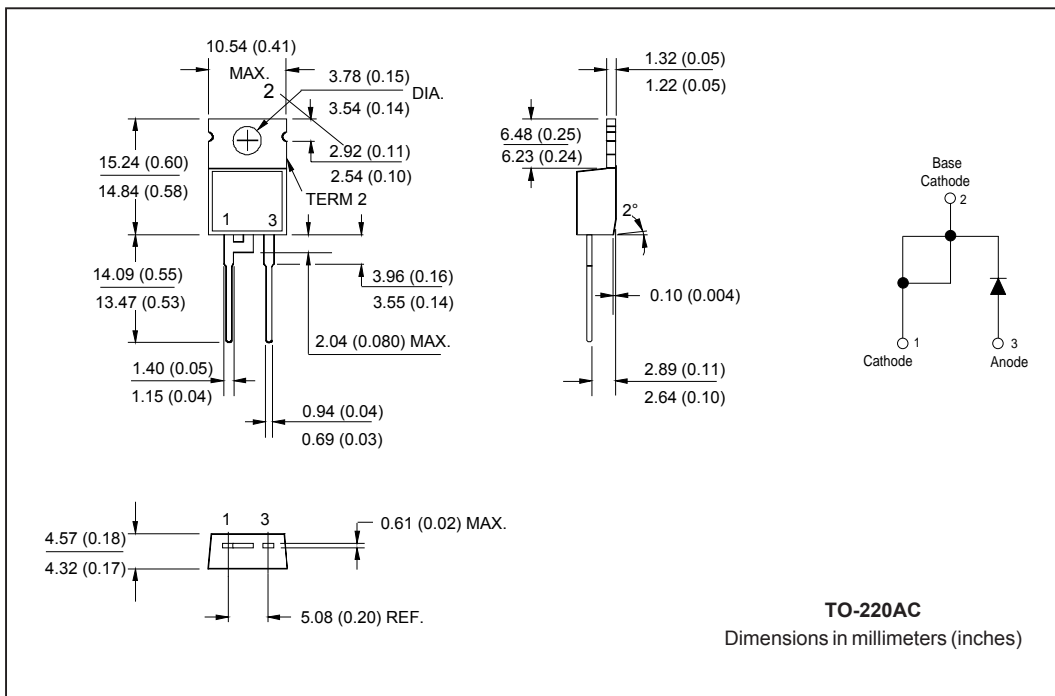
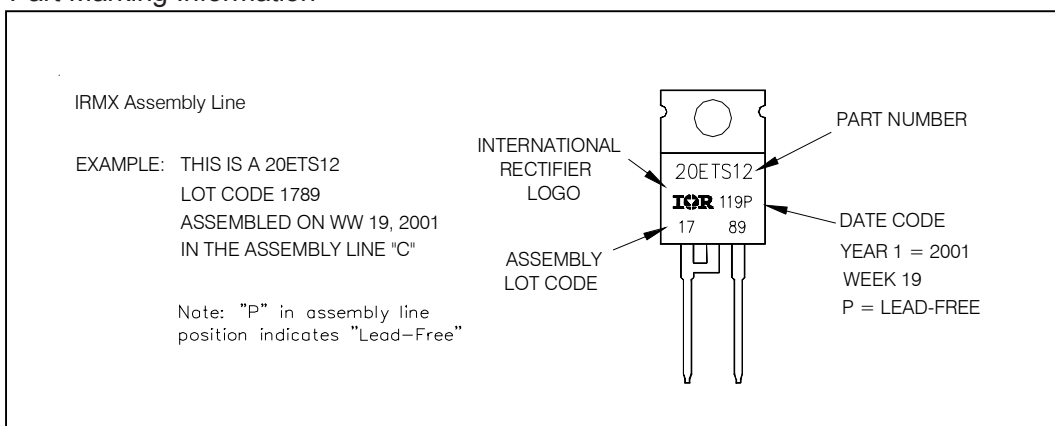

Fig. 8 - Thermal Impedance Z_{thjC} Characteristics

Outline Table



Part Marking Information



Ordering Information Table

Device Code					
20	E	T	S	12	PbF
①	②	③	④	⑤	⑥
1	- Current Rating (20 = 20A)				
2	- Circuit Configuration E = Single Diode				
3	- Package T = TO-220AC				
4	- Type of Silicon S = Standard Recovery Rectifier				
5	- Voltage Rating (12 = 1200V)				
6	- • none = Standard Production • PbF = Lead-Free				

Data and specifications subject to change without notice.
This product has been designed and qualified for Industrial Level and Lead-Free.
Qualification Standards can be found on IR's Web site.