

HIGH PERFORMANCE LOW-NOISE DUAL OPERATIONAL AMPLIFIER

■ GENERAL DESCRIPTION

NJM2114 is a high performance dual low noise operational amplifier that could be replaced in application with NJM5532. Comparing to NJM5532; it has superior specifications on Slew Rate, Bandwidth and Offset Voltage. Furthermore lower noise and distortion are achieved, it is applicable for Hi-Fi audio equipments.

■ FEATURES

- Operating Voltage ($\pm 3.0V \sim \pm 22.0V$)
- High Slew Rate ($15V/\mu s$ typ.)
- Wide Unity Gain Bandwidth ($13MHz$ typ.)
- Low Noise Voltage ($0.9\mu V_{rms}$ typ.)
- High Output Current ($60mA$ typ.)
- Package Outline DIP8, DMP8, SIP8
- Bipolar Technology

■ PACKAGE OUTLINE

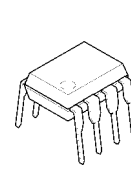

NJM2114D

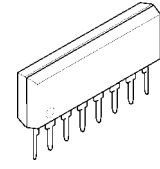

NJM2114L



NJM2114M

■ PIN CONFIGURATION

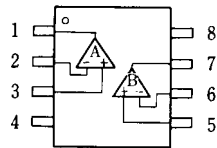

NJM2114D
NJM2114M

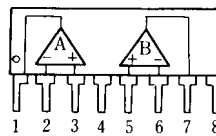

NJM2114L

PIN FUNCTION

- 1.A OUTPUT
- 2.A -INPUT
- 3.A +INPUT
- 4.V⁻
- 5.B +INPUT
- 6.B -INPUT
- 7.B OUTPUT
- 8.V⁺

■ EQUIVALENT CIRCUIT

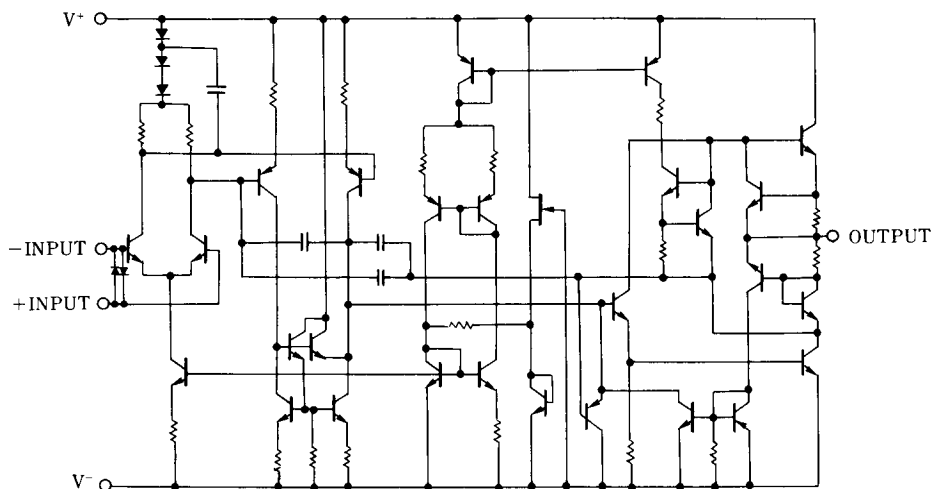

NJM2114

■ ABSOLUTE MAXIMUM RATINGS

(Ta=25°C)

PARAMETER	SYMBOL	RATINGS	UNIT
Supply Voltage	V^+ / V^-	± 22	V
Input Voltage	V_{IC}	V^+ / V^-	V
Differential Input Voltage	V_{ID}	± 0.5	V
Power Dissipation	P_D	(DIP8) 800 (SIP8) 800 (DMP8) 600 (note)	mW
Operating Temperature Range	T_{opr}	-20~+75	°C
Storage Temperature Range	T_{stg}	-40~+125	°C

(note) At on PC board

■ ELECTRICAL CHARACTERISTICS

Direct Current Characteristics

($V^+ / V^- = \pm 15V, Ta = 25^\circ C$)

PARAMETER	SYMBOL	TEST CONDITION	MIN.	TYP.	MAX.	UNIT
Operating Current	I_{CC}		-	9	16	mA
Input Offset Voltage	V_{IO}		-	0.2	3	mV
Input Offset Current	I_{IO}		-	0.01	0.3	uA
Input Bias Current	I_B		-	0.5	1.8	uA
Common Mode Input Voltage Range	V_{ICM}		± 12	± 13	-	V
Common Mode Rejection Ratio	CMR	$V_{ICM} = 12V$	70	100	-	dB
Supply Voltage Rejection Ratio	SVR	$V^+ / V^- = \pm 22 \rightarrow \pm 11V$	80	100	-	dB
Large Swing Voltage Gain 1	A_{V1}	$R_L \geq 2k\Omega, V_O = \pm 10V$	88	110	-	dB
Large Swing Voltage Gain 2	A_{V2}	$R_L \geq 600\Omega, V_O = \pm 10V$	83	104	-	dB
Maximum Output Voltage 1	V_{OM1}	$R_L \geq 600\Omega$	± 12	+14/-13	-	V
Maximum Output Voltage 2	V_{OM2}	$R_L \geq 600\Omega, V^+ / V^- = \pm 18V$	± 15	+17/-16	-	V
Input Resistance	R_{IN}		-	100	-	k Ω
Output Current	I_O		-	60	-	mA
Slew Rate	SR	$G_V = 20dB, R_L = 2k\Omega$	-	15	-	V/ μs
Gain Bandwidth product	GB		-	13	-	MHz
Equivalent Input Noise Voltage	V_{NI}	20Hz~20kHz	-	0.9	-	μV_{rms}
Equivalent Input Noise Voltage	e_N	$f_o = 30Hz$	-	5.5	-	nV/ \sqrt{Hz}
Equivalent Input Noise Voltage	e_N	$f_o = 1kHz$	-	3.3	-	nV/ \sqrt{Hz}
Equivalent Input Noise Current	I_{NI}	$f_o = 30Hz$	-	1.5	-	pA/ \sqrt{Hz}
Equivalent Input Noise Current	I_{NI}	$f_o = 1kHz$	-	0.4	-	pA/ \sqrt{Hz}
Total Harmonic Distortion	THD	$f = 1kHz, V_O = 5V$	-	0.0005	-	%

■ NOTE

In the application as a voltage follower, there might be the case the inputs are damaged especially the moment the supply voltage is switched on.

That's why we recommend you to put the current limiting resistor at the input pin.

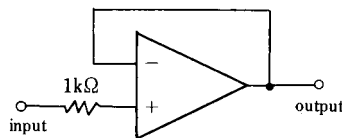

■ TYPICAL CHARACTERISTICS

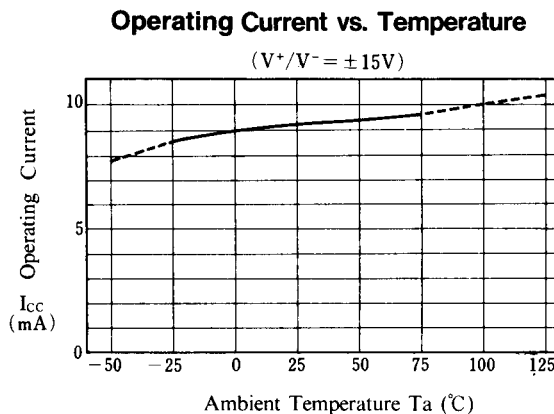
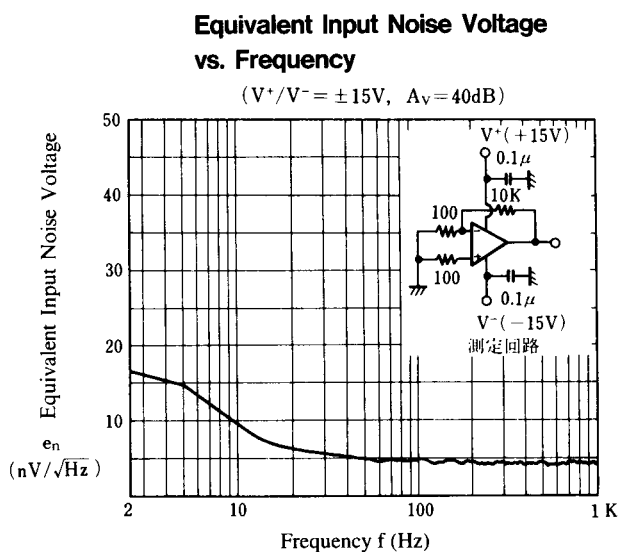
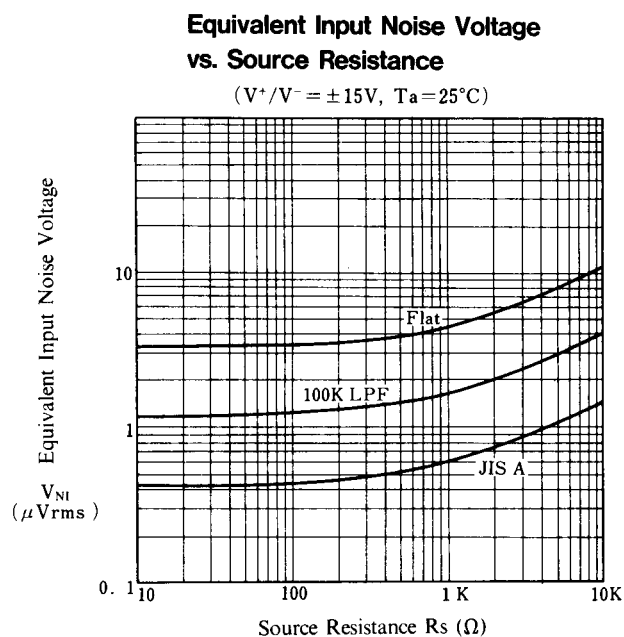
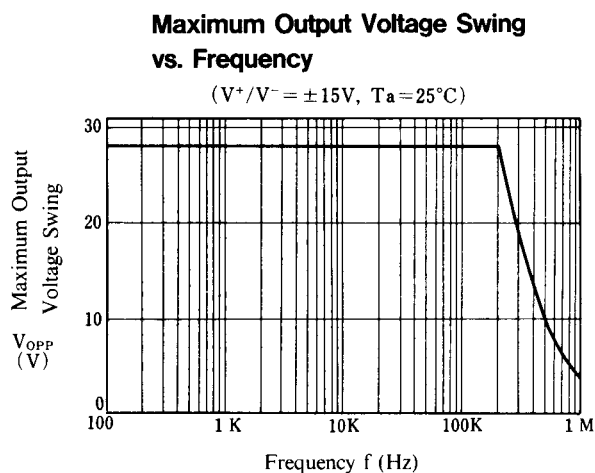
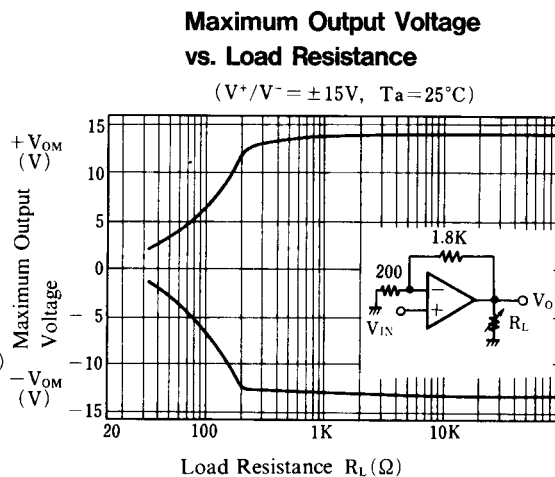
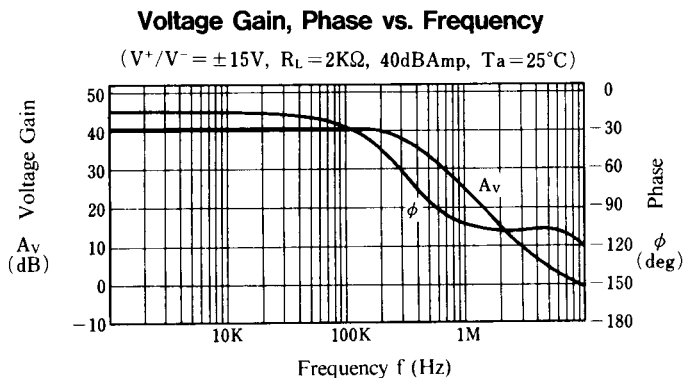

■ TYPICAL CHARACTERISTICS

Input Offset Voltage vs. Temperature

($V^+/V^- = \pm 15V$)

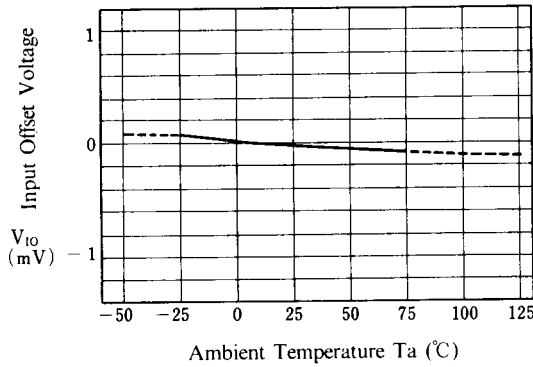

Input Bias Current vs. Temperature

($V^+/V^- = \pm 15V$)

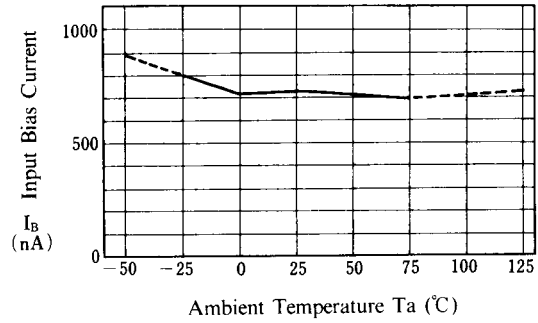

Maximum Output Voltage vs. Operating Voltage

($R_L = 600\Omega, T_a = 25^\circ C$)

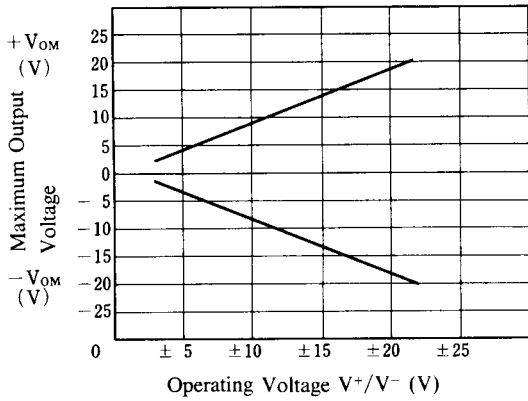

Total Harmonic distortion vs. Output Voltage

($V^+/V^- = \pm 15V, R_L = 10k\Omega, Gain = 20dB, T_a = 25^\circ C$)

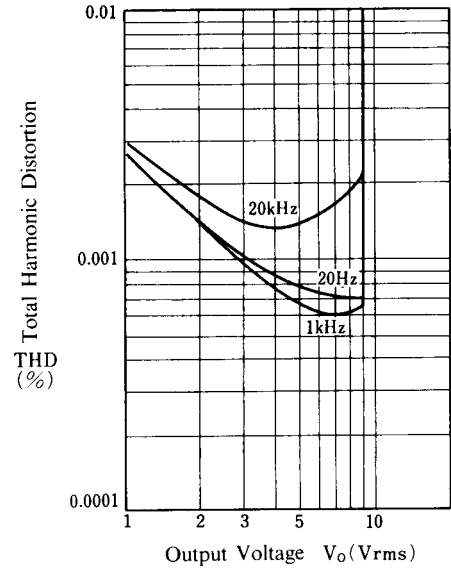

Operating Current vs. Operating Voltage

($T_a = 25^\circ C$)

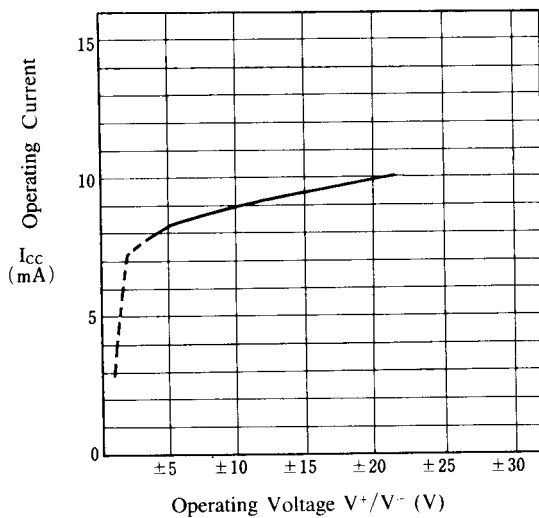

[CAUTION]

The specifications on this databook are only given for information, without any guarantee as regards either mistakes or omissions. The application circuits in this databook are described only to show representative usages of the product and not intended for the guarantee or permission of any right including the industrial rights.