

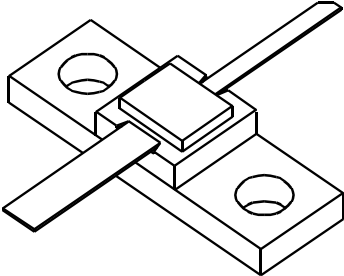

2223-1.7

1.7 Watts - 24 Volts, Class C
Microwave 2200 - 2300 MHz

<p>GENERAL DESCRIPTION</p> <p>The 2223-1.7 is a COMMON BASE transistor capable of providing 1.7 Watts of Class C, RF output power over the band 2200 - 2300 MHz. This transistor is designed for Microwave Broadband Class C amplifier applications. It includes input prematching and utilizes Gold metalization and diffused ballasting to provide high reliability and supreme ruggedness. The transistor uses a fully hermetic High Temperature Solder sealed package.</p>	<p>CASE OUTLINE 55LV, STYLE 1</p> 
<p>ABSOLUTE MAXIMUM RATINGS</p> <p>Maximum Power Dissipation @ 25°C 7 Watts</p> <p>Maximum Voltage and Current</p> <p>BVces Collector to Emitter Voltage 45 Volts BVebo Emitter to Base Voltage 3.5 Volts Ic Collector Current .25 Amps</p> <p>Maximum Temperatures</p> <p>Storage Temperature - 65 to + 200°C Operating Junction Temperature + 200°C</p>	

ELECTRICAL CHARACTERISTICS @ 25 °C

SYMBOL	CHARACTERISTICS	TEST CONDITIONS	MIN	TYP	MAX	UNITS
Pout	Power Output	F = 2.2 - 2.3 GHz	1.7			Watts
Pin	Power Input	Vcc = 24 Volts			.25	Watts
Pg	Power Gain		8.3			dB
ηc	Efficiency			35		%
VSWR	Load Mismatch Tolerance				10:1	

BVces	Collector to Base Breakdown	Ic = 10 mA	40			Volts
BVebo	Emitter to Base Breakdown	Ie = 2 mA	3.5			Volts
Hfe	Current Gain	Vce = 5 V, Ic = 160mA	10		100	
Cob	Output Capacitance	Vcb = 28V, 1MHz				pF
θjc	Thermal Resistance	Tc = 25 °C			24	°C/W

Issue A June 1997

GHZ TECHNOLOGY INC. RESERVES THE RIGHT TO MAKE CHANGES WITHOUT FURTHER NOTICE. GHZ RECOMMENDS THAT BEFORE THE PRODUCT(S) DESCRIBED HEREIN ARE WRITTEN INTO SPECIFICATIONS, OR USED IN CRITICAL APPLICATIONS, THAT THE PERFORMANCE CHARACTERISTICS BE VERIFIED BY CONTACTING THE FACTORY.

GHZ Technology Inc. 3000 Oakmead Village Drive, Santa Clara, CA 95051-0808 Tel. 408 / 986-8031 Fax 408 / 986-8120

EFFICIENCY VS POWER IN

FREQUENCY=2.25 GHz

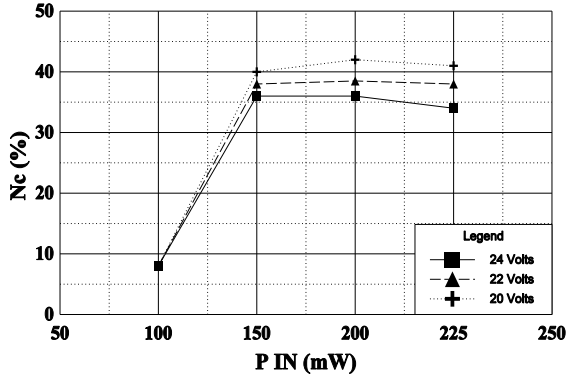

POWER OUTPUT VS POWER INPUT

FREQUENCY=2.25 GHz

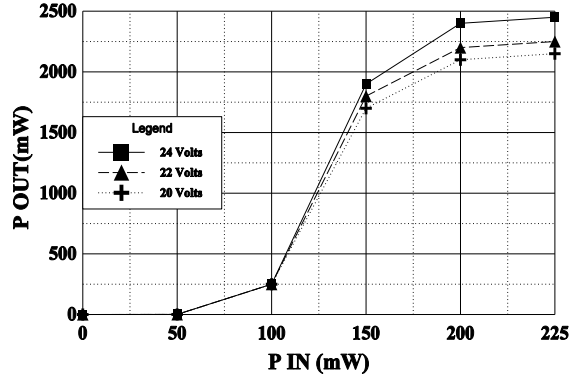

INPUT IMPEDANCE

Vcc=22V, Pin=.25Wk

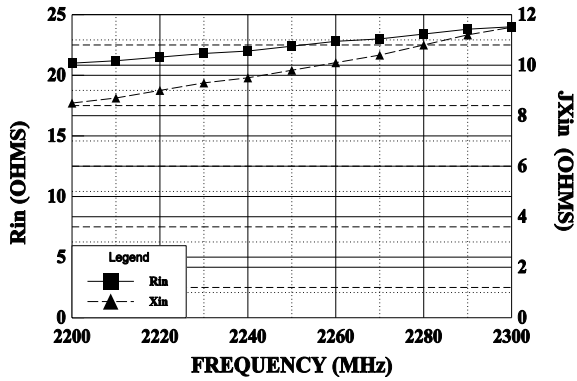

LOAD IMPEDANCE

Vcc=22V, Pin=.25W

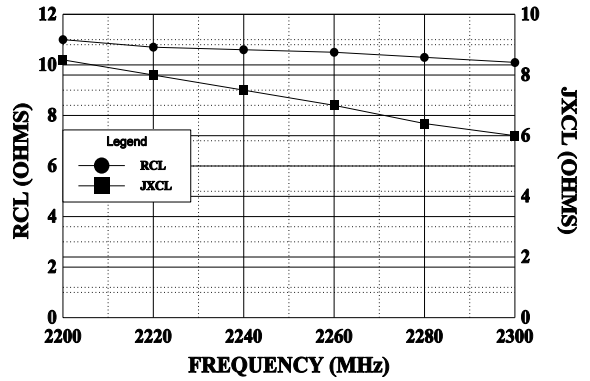

REVISIONS

ZONE	REV	DESCRIPTION	DATE	APPROVED
------	-----	-------------	------	----------

DIM	INCHES
A	.200
B	.350
C	.160
D	.053
E	.100
F	.455
G	.230
H	.300
I	.245
J	.330
K	.270
L	.500
M	.445
N	.150
O	.800
P	.150
Q	.190
R	.053

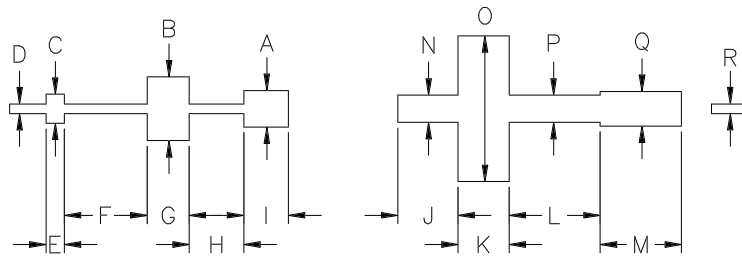

2223-1.7 TEST CIRCUIT

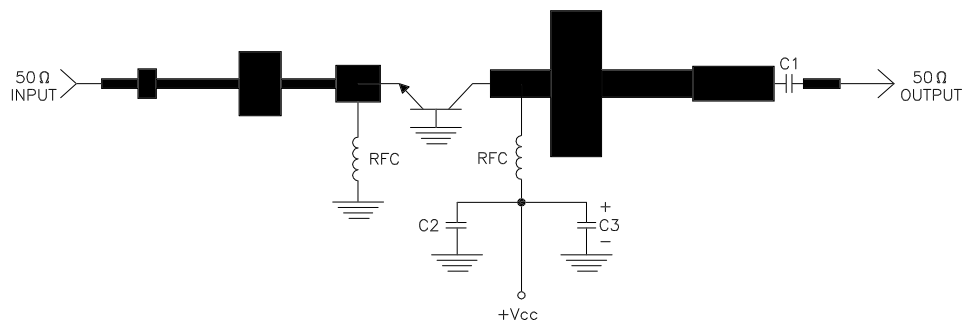

DIELECTRIC = 19.4 MIL THICK TFE Er = 2.43
 C1, C2 = 62pF CHIP ATC "A"
 C3 = 10MFD @ 35V
 RFC = 4 turns #22 wire on 1/16" dia.



CAGE OPJR2	DWG NO. 2223-1.7	REV A
SCALE 1/1	SHEET	